

Fundamental Concepts of Architecture

Alban Janson
Florian Tigges

Fundamental Concepts of Architecture

The Vocabulary of Spatial Situations

Birkhäuser · Basel

Introduction

A description solely in terms of form, dimensions, construction and materials would hardly do justice to Balthasar Neumann's staircase in the Bruchsal Palace. Even the most penetrating characterization, taking into consideration the structure's history and context and its original and current functions, would miss its specifically architectural qualities if we fail to account for our experience in concrete terms. An initial approach to the staircase leads into darkness; at the same time, we are confronted with an alternative to the cave-like atmosphere below in the form of ascending to the right or to the left, guided upwards by light, sweeping outward in an almost dancelike manner between dark depths and bright natural light, with no indication as yet of where the staircase ultimately leads. We continue upwards, sweeping back until we reach an oval platform that seems to be suspended in space, detached from the walls and deprived of support, and vaulted over by the colourful, mysteriously illuminated depiction of the heavens on the ceiling, which serves as an antipode to the darkness below.

The specifically architectural qualities which concern us here pertain to the articulation of all conceivable spatial relationships by means of specifically architectural resources.

Neither technically nor formally is the production of objects the principal task of architecture; instead, it is charged principally with creating suitable spatial situations for lingering at various locations, for movement and for action. Decisive here is the interplay between the spatial features of the constructive elements involved and the circumstances under which they are perceived, used, and experienced.

Fundamental Concepts in Architecture comprehends these architectural situations from the perspective not of de-

sign, but of experience. The key consideration of architectural design is the way in which people experience the buildings that have been created for them. Although the terms ‘roof’, ‘base’ and ‘wall’ do appear in this volume, the individual concepts do not refer primarily to constructive contexts; while the terms ‘axis’, ‘enfilade’ and ‘proportion’ are considered, we do not represent an aesthetic doctrine of building shapes; nor is it our intention to locate these terms within the history of architecture. Nor, finally, will concepts be generalized within a broad sociocultural context. Instead, the concrete architectural phenomenon is foremost; description concentrates on the situative contents of the respective term in close connection with concrete structural-spatial form.

Fundamental Concepts in Architecture contains no scientific definitions and does not offer the kind of information normally found in reference books; instead, the reader is invited to examine architecture from an experiential perspective. Via observations of architectural situations in relationship to these basic concepts, the reader is offered an instrument designed to orient, hone and expand his or her perceptions, a resource for clarifying one’s own concrete experiences of architecture in relation to the terms elucidated here.

That the contents of these terms can only be adequately comprehended in relation to subjective experience does not mean that they possess only individual validity. As soon as subjective perceptions and experiences are described with lucidity and precision, they are amenable, in principle, to verification by anyone who exposes himself to the conditions specified. We can speak with Josef König in saying that the immediate aptness of such statements cannot be certified, but instead only recognized in specific instances (1957, 284). To restrict our descriptions to the measurable, the quantifiable, to putatively objective fact, would constitute culpable neglect, would exclude what is most valuable in architecture, including its essential aspects. Our psychological states depend upon the significance and the intellectual demands made upon us by

the physical environment, by its appeals and atmospheres, at least as much as they do upon things like ‘street-cleaning’ and ‘house keys’ (Karl Kraus) – although we often lack a term for the former. As a rule, in any event, a precise and comprehensive description of the phenomena of architectural experience surpasses the degree of differentiated attention entailed by the casual perceptions of the typical architectural consumer. But because subliminal effects are just as important, architects must possess an exact knowledge of the phenomena they are responsible for generating.

For ancillary architectural disciplines such as building technology, architectural and art history, building law and planning theory, there exist very precise, codified terminological definitions. It is considerably more difficult to attain conceptual clarity in the core area of architecture, so often plagued by imprecise and clichéd terminology. It is much easier to define terms such as ‘vapour barrier’, ‘wimperg’ or ‘Land Use Ordinance’ than it is to explain in words what constitutes a spatial > gesture or a spatial > sequence. The specificity of architectural situations can be grasped less through historical, technical or planning-theoretical terminology than through the phenomenological description upon which *Fundamental Concepts in Architecture* relies.

While this compendium makes no claim to constitute a complete, self-contained conceptual system, the form of this dictionary, with its hypertextual structure of references, defines individual terms not solely within a given entry; instead, each term acquires precision by registering differences and potentials for connection in relationship to others. This intricate and closely woven set of relationships forms a conceptual network, one capable of capturing essential features of architectural experience.

While our experience of architecture is describable, it can only be illustrated graphically to a limited degree. For the most part, the accompanying sketches are intended to illustrate a few basic structural conditions as examples.

Terms

Access	11	Door and gate	92
Accessibility and exclusivity	13	Dramaturgy	96
Angle and corner	15	Dwelling	97
Appeal	16	Empathy	98
Arcade	18	Enfilade	100
Architecture	20	Entrance (theatrical)	101
Ascent	22	Event	102
Atmosphere	26	Expansiveness and constriction	104
Axis	29	Experience	107
Base	31	Expression	109
Beauty	32	Extension	111
Body, architectural	35	Facade	113
Body, human	37	Field	116
Capacity	40	Figure of movement	118
Ceiling	43	Filter	120
Cell	46	Flowing space	122
Cellar	48	Folding	123
Centring	50	Force field	124
Circulation	53	Form character	126
Closure	54	Furnishing	130
Colour	56	Gallery	134
Column	60	Garden	135
Comfortableness	62	Gathering	138
Complexity	63	Gaze	139
Composition	65	Gestalt	142
Concavity and convexity	67	Gesture, spatial	144
Concept, architectural	70	Ground	146
Confrontation	71	Hall	149
Context	73	Haptic qualities	150
Courtyard	75	Heaviness and lightness	153
Covering	79	Image	156
Darkness	80	Incorporation	160
Density, spatial	83	Ingress and exit	162
Depth	85	Inside and outside	164
Detail	87	Interior	166
Directionality	89	Intermediate space	168
		Intimation	172
		Introduction	173

Inversion	173	Scale	268
Invitation character	176	Scene	271
Joint	177	Screening	274
Landscape	178	Sensory perception	276
Layering	180	Sequence	278
Light	182	Sign	280
Materiality	189	Simplicity	282
Meaning	192	Situation	284
Measure	195	Size	285
Memory	197	Sound	288
Monument	199	Space	291
Movement	202	Space-body continuum	293
Odour	205	Space-containing wall	296
Opening	207	Space shadow	298
Order	209	Spatial structure	300
Orientation	212	Square and street	303
Ornamentation	214	Stairs	307
Oscillation	216	Structure	312
Patina	217	Sublimity	314
Personal space	220	Surface	316
Perspective	223	Symbol	319
Picturesque	226	Symmetry	321
Place	228	Synaesthesia	323
Plane	231	Tectonics	325
Poché	233	Territory	327
Porosity	235	Theme, architectural	330
Postures	236	Threshold	331
Proportion	240	Time	335
Raumplan	243	Tower	338
Readability	245	Transparency	339
Residence	247	Type	342
Resonance space	252	Urban design	344
Rhythm, spatial	253	Use	348
Ritual	255	Views into/out of	351
Roaming	259	Virtuality	353
Roof	260	Wall	355
Route	264	Warmth and cold	359
Row	266	Window	361

Access

Streets and routes, corridors and staircases are not only systems of access but also keys to the communal lives of occupants. Because they provide information concerning the distribution of spaces and the patterns of movement that connect them, access systems and the gestalts of access spaces condition and express social structures. The structure and development of urban districts and entire cities is recognizable through the development of transport infrastructure; neighbourly relations are mirrored in the types of vertical accesses found in multistorey buildings; forms of residency are displayed in the accesses of apartment layouts.

All types of accesses simultaneously reflect and influence living conditions: playing a role in everyday life is the question of whether a family lives in direct proximity to open space or in an upper storey, whether they live alone or together with several neighbours in a two-family house, or with many neighbours in a balcony access building. Everyday working conditions are also affected by whether a workplace is set in an office cell along a corridor or in a large open-plan office. Corridors were invented as independent distribution spaces in order to exclude disturbances from main or common rooms, which then, ideally, had only single doorways. The precondition for this arrangement is a strict distinction between the corridor as a > route and the room as the destination towards which it leads. To be sure, the corridor access as a primary system of routes simplifies connections between rooms, but at the same time it reduces contact. Purposeful, regulated communication is facilitated, while reducing contingent contacts. As Robin Evans has shown, this access structure determines the role and the spatial character of the private sphere to a substantial degree. It stands in opposition to an access system that facilitates informal contact via a plan in which rooms are not accessed via corridors that serve as distribution channels, but instead via connecting rooms with multiple doors, as was customary up until the seventeenth century. In this instance, the basic concept of the building was that of an open form,

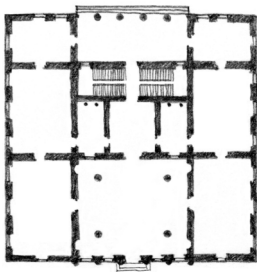

a ‘matrix of discrete but thoroughly interconnected chambers’ (Evans 1996) that served the nuanced navigation of desired or habitual contact and promoted conviviality.

The configuration of access provides information about the architectural > concept within which the > spatial structure is concentrated. In typologies of building design, access is the most common parameter. Often, a building’s architectural composition and its appearance are substantially shaped by the configuration of accesses. Striking instances include Andrea Palladio’s Villa Rotonda, Frank Lloyd Wright’s Guggenheim Museum, and Hans Scharoun’s Ledigenwohnheim (single men’s hostel). Individual access spaces such as hallways, staircases or entrance halls may be shaped in such a way that they open up spaces of > orientation or overviews (> gallery) or serve to introduce (> introduction) the building’s structure rather than being downgraded in design terms as ancillary rooms.

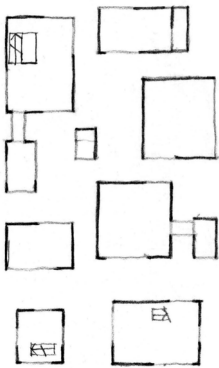

Theatre and hotel lobbies serve purposes not only of access, but also of informal encounter; the same is true of the lobbies of research institutes, since incidental communication can be highly productive and promote knowledge exchange. In apartment buildings as well, access spaces can be designed to promote incidental contacts as well as facilitating circulation. This task is also assumed by contained outer spaces, such as the > courtyard of an atrium or courtyard residence, and in some cultures also the enclosed or open > intermediate space between small houses for the members of the family, a flat sharing community, or individual functions. In the Moriyama House by SANAA, the open space – which alternates between public and private – merges with the urban realm.

If we consider that accesses not only mediate between public and private areas, but must also differentiate between various degrees of > accessibility, then – according to Dorrothea and Georg Franck – they represent a hierarchy of fractal structures within which each room contains further forms of access as well as being accessed. They form a continuous

sequence all the way from the city as a whole down to the room as a 'space of access for cabinets and compartments'.

Literature: Evans 1996; Franck/Franck 2008

Accessibility and exclusivity

Architecture may be grasped as a complex, graduated system of accessibility. Wherever people live simultaneously as individuals and in collectives, there is a task of grading the individual's private sphere in relation to communal and public areas. But it is not enough simply to distinguish between the poles of private and public: accessibility and exclusivity must be continuously graded, either as a > sequence of rooms or in the > spatial structure of the building of the whole. These relationships are organized architecturally through the subdivision and arrangement of separate rooms that are distinguished from one another in terms of their qualities of intimacy and publicness through size, illumination and furnishings, thereby suggesting specific modes of comportment. Their accessibility is steered additionally by insertion of > intermediate spaces and by differentiated degrees of the permeability (> filtering) of > screening.

The positioning and arrangement of rooms thereby forms a sequence of opening and opened up (screened off) rooms, from the most secluded and increasing by degrees of accessibility, so that the number of people admitted is staggered gradually. In the broadest sense, we find a continuous spectrum from streets and squares, to semipublic zones such as the interiors of residential blocks or entrance lobbies, and all the way to individual rooms.

Within a building, we may find a series of spaces graded according to exclusivity, as in the > enfilades of princely palaces. In other plans, the entry to private rooms is via the building's semipublic spaces, including atriums, halls, or salons, depending on the type of > access. Decisive is the degree of the isolated position in the plan, and its reachability or distance from the building's (semi-)public spaces. If access to a room

is via a series of connecting rooms rather than a corridor, the number of rooms to be traversed is a measure of accessibility (> depth). The relationship between a sense of security and freedom of movement is displaced at every stage. The constitution of the screening is also decisive. It determines the degree of closeness, views into the room, and acoustic separation. Gradual filtering facilitates various degrees of separation, from total closure to a semi-permeable screening that only alludes to separation, and all the way to the lightweight folding screen. The sliding walls found in a traditional Japanese house, for example, regulate accessibility without sharp spatial limitations and unambiguous hierarchies, allowing the possibility, for example, for figures behind the wall to be seen, albeit dimly, and for voices and noises to remain audible without their sources becoming visible. The background for requirements of accessibility and exclusivity are formed by various culturally conditioned notions of intimacy.

It is not just a question of providing opportunities for individual seclusion or social interaction found at the far ends of a scale of privacy; instead, every gradation of accessibility and exclusivity shapes the conditions of social interaction in subtle ways. Individual activities can be assigned corresponding positions on the privacy scale; the spectrum covers types of sociability, discreet encounters, concentrated work, or total encapsulation. At every gradation, the type of > personal space finds its corresponding extension.

Literature: Evans 1996; Franck/Franck 2008

Acoustics	> sound
Aesthetics	> beauty, experience, image, picturesque, scene, sensory perception, use
Age/Ageing	> materiality, monument, patina, time
Ambulation	> arcade, movement, rhythm (spatial), route, sequence

Angle and corner

A simple > concavity results when two planes converge to form an angle. The Greek word ἀγκύλος (*ankylos*), from which the word *angle* derives, means ‘crooked’ or ‘curved’; the Latin *angulus* means ‘corner’. When a wall surface is bent, or when a pair of walls are configured to form an angle that is not excessively acute or obtuse, they begin to enclose a space, a volume that is perceptible as being an > interior, producing a condition of ‘insideness’. And an angle formed by folding a wall around an adjacent floor area spans a diffusely delimited space like a kind of cast shadow (> space shadow). Three walls that form a ‘U’ represent an extension of the angle. When forming an acute angle, the planes seem constricting; if they form an obtuse one, expansive; a right angle tends to have a neutral effect, and occupies an inconspicuous intermediate position.



As a screening element, the angled wall is a simple means of excluding gazes and of sequestering a space. Outdoors, it serves as a wind shield, and the combination of wall and roof forms a primitive shelter. In the urban context, spaces are formed by the interplay of structures, and the angle between two facades is a basic element for stabilizing spatial figures, in particular the edges of public squares; in Venice, for example, many church forecourts are framed by two facades set at an angle (*a canto*) between the church front and the neighbouring building.

In interiors, corners are zones characterized by heightened forms of introversion. In contrast to straight walls and rounded rooms, corners embody narrowness. In angles, space becomes condensed, gathered together. Just as a pair of outspread arms in a receptive gesture encloses a small space, the angle between walls opens up to receive space. A stance with the corner of the room behind one’s back offers a good overview, while the (right) angle formed by the walls corresponds, for example, to the angle of vision. Given the geometry of the angle, withdrawing into a corner means entering an increasingly narrow space, opting for restriction of movement,

which however may be exited again by taking a few steps. The general significance of the angle as a secluded and sheltering space comes into its own when it is used as a place of individual refuge, as a play or sulking corner, as an intimate interspace between bed and wall, or heightened ritually to become a domestic shrine.

The corner displays, in connection with the building as a whole, and generally on the outside, the relationship between two adjacent walls. From the corner, one's > gaze is guided around the building. A unified appearance may be aimed for all the way around, in which case the corners – as the results of the spatial condensation of specific rhythms of articulation – must resolve certain conflicts associated with corners since antiquity. Or else walls of divergent characters meet at a corner, making it clear that the building turns towards contrasting neighbouring structures by means of differing wall design. Also recognizable at the corner is the way in which a facade is set in front of the building, thereby assuming priority as its principal side. Aimed for via the alternation of concave and convex corners is a > folding of the walls, which result in transitions between open spatial areas and introverted zones. A space may be folded into itself and everted, the result being a spatial > inversion. The niches, angles and corners formed in this way are available for differentiated individual uses, and may take on the character of a > space-containing wall.

Literature: Bachelard 1964/1994

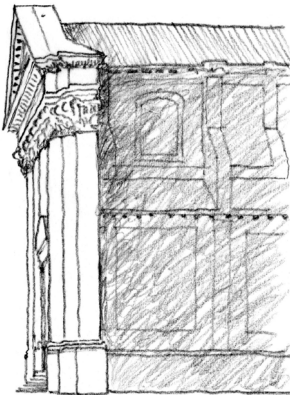

Announcement

> intimation

Anteroom

> courtyard, intermediate space, inversion, square and street

Apartment

> furnishing, residence, territory

Appeal

Appeals are architectural > expressions, by which we feel ourselves influenced especially strongly. In architecture, they are conveyed through structures and spatial situations that ad-

dress the beholder directly in an initial phase of perception within which moods and feelings emerge, subliminal expectations are aroused, and corresponding reactions are triggered. Among the expressive qualities of > form character and > atmosphere, an appeal is distinguished by the way in which it is intensified to constitute a suggestive effect that is not easily evaded.

The appeal of a concave form, for example, is often experienced as receptive in character, while the expressive quality of a tall, looming tower is perceived as commanding, if not menacing. Many appeals address us in relation to our spatial comportment, for example, when forms and situations appear seductive or uninviting, approachable or constricting. The appeal of dynamic expressive qualities is apparent in particular in relation to spatial > gesture; a low, dark ceiling, for example, seems oppressive, a vault containing an ascending spatial form uplifting. In appeals, atmospheric qualities appear especially insistently by virtue of their influence on our mental states; through their suggestiveness, buoyant atmospheres may cheer or attract us, and gloomy ones may seem hostile or depressive. More strongly than with other architectural forms of expression, appeals elicit a specifically emotional interaction with the respective situation. Our responses are dependent upon personal predispositions; we involuntarily make adjustments between appeals and our own needs, expectations and experiences. Impulses towards spatial behaviour that emerge from an appeal, i.e. to avoid hurrying in a church, are perceived as imperative – independently of whether or not we heed them. Of relevance for concrete experience, in any event, is the extent to which an appeal – despite all of its indeterminacy – suggests movements such as approach, entrance or traverse (> invitation character), or commends the adoption of specific postures and positions in space.

Literature: Arnheim 1977/2009; Böhme 1998; Dürckheim 2005

Approach

Appropriateness

Appropriation

> intimation, introduction, sequence

> complexity, light, meaning, ornament, proportion, size

> capacity, complexity, order, ornament, territory, residence, urban design

Arcade

Set in front of a building, an arcade constitutes an > intermediate space belonging simultaneously to the building and the space outside. Primarily the arcade is a range of arches carried on piers or columns. The term also refers to the space as a whole, which – as in the cases of the pergola, covered walk, loggia, colonnade and > gallery – constitutes an independent spatial category that emerges from the superposition of exterior and exterior spaces (> transparency). Everything said below about the arcade is true by analogy of these forms as well. As roofed passageways or halls that are open on at least one side and delimited as a rule only by a series of supports, columns or pillars, such spaces possess a public character, while also allowing more sheltered forms of use; at the same time, functions taking place in the building's interior may expand outward into the space of the arcade.

In its most economical form, this function is assumed already by the open > space-containing wall of a > facade. When we traverse such permeable spatial layers, which create distance, on the way between > inside and outside, they influence the act of transition as zones of interaction and changing behaviour. Spacious, open arcades are easily traversed; stocky covered walks with thick pillars seem to lead into dark, cool grottoes, while the columned portico is still an especially dignified form.

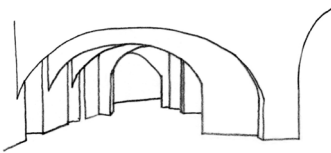

In cities with streets lined with spacious arcades, the street fronts seem to have been covered with a permeable, porous layer that loosens up facade contours. As a lengthwise extension along the street, the arcade forms a continuous link between individual buildings and effects unity in relation to their heterogeneity. In the arcade passageway, we move along

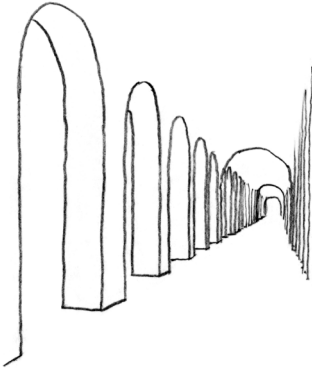

a space-containing boundary between inside and outside, and enjoy the option of exiting into the outer space or re-treating into the interior. Arcades allow us to pass without interruption through a town in a weather-protected ‘shadow gap’ that is set alongside architectural masses. The curve of each arch (*arcus*), which leads without interruption from one zone to the next, along with the continuous > sequence of the supports, endows our promenade with > rhythm. When the gaze is directed into the distance, the optical narrowing of the intercolumnar zones generates the impression of a closed interior space. Without warning, passersby enter through the ‘wall’ formed of the supports; but we never actually reach this ‘wall’; upon approach, we find it has already dissolved.

The uniform repetition of arches, pillars and spatial units promotes a contemplative > circulation or relaxed strolling. From the outside, the passerby is perceived as continually vanishing and reappearing; by the same token, the outer world lying beyond the arcade disappears and returns to sight. When the sun is shining, we alternate ceaselessly between shadowy and light-flooded zones. By virtue of their perpetual alternation, such contrasts of light and shadow – so typical of the arcade – seem to possess a magical potential – as in the paintings of Giorgio de Chirico’s *pittura metafisica*, where arcades serve as frames and backdrops for enigmatic and concealed events (> picturesque). In roofed pilgrimage routes, pergolas and foyers, the arcade gains its independence as a freestanding structure. When turned inward as peristyle or cloister to form the ambulatory of a > courtyard or garden, it may be regarded as an eversion (> inversion) of the street arcade – not unlike the side aisle of a basilica that flanks the nave.

Literature: Schmalscheidt 1987

Arch
Archetype

> arcade
> dwelling, type

Architecture

The concept of architecture is extensible – all the way to Hans Hollein's assertion: 'Everything is architecture'. If we regard the function of architecture as being primarily to 'articulate spaces' (Eco 1986), then the 'architectonic' element of architecture can be characterized (1) in terms of the application of specific resources; (2) in terms of its structural systematics; and (3) in terms of the way in which it is experienced.

1. Contributing to architectural resources, to be sure, is a multiplicity of factors (form, construction, material, light, colour), all of them also effective in other domains. Some components, on the other hand, are essential to architecture as they are for no other discipline.

These include the reciprocal conditioning of three-dimensional masses (convexities) and contained volumes (concavities), i.e. the complementary relationship between > bodies and > spaces. Space can be shaped and experienced, can be rendered habitable, only when it is contained and shaped by bodily elements, while architectural structures and masses count as such only when they are surrounded by space. Physical masses offer resistance to our own bodies, while the voids between them afford us space for movement and for vision. In the relationship between bodies and space, architecture articulates the relationship between figure and ground (> space-body continuum), one that is fundamental for perception.

The instrument referred to as > screening is also based on complementary and reciprocal effects. It controls the relationship, which is constitutive for architecture, between > interior and exterior, i.e. by simultaneously separating and linking them.

A primordial architectural act is the generation of an interior space via its delimitation from a surrounding external space, whether natural or urban. The condition of a space's usability, in turn, is the overcoming of this separation by means of openings that join interior and exterior. In a corresponding way, screening also regulates the relationship between various interior spaces or between separate urban spaces. As a

consequence, and despite the opposition between interior and exterior, between vision and connection, the architecture provides us with a sense of their unity.

An originary task of architecture, finally, is its confrontation with a concrete > place. From the special features of a place, the work of architecture develops an identity and achieves a stable presence via its rootedness in the place. As soon as a building occupies a location, it interacts with the local context and transforms it. The building's continued existence requires stability and solid construction. But as a spatial totality, it cannot be perceived from a static position, but must be experienced and used through the act of traversing it, via continual changes of position. Architecture, then, despite its permanent rootedness in a place, always also consists of > sequences of spatial units linked together by > movement into a temporal progression. It thereby endows the relationship between simultaneity and succession with concrete expression (> time).

2. By 'architecture' in a general sense, we understand a methodical construction in which the configuration of parts results in a whole, such as the elements of a set of agreements or the components of an equipment system. 'Architecture' also means, in a figurative sense, the elaborated structuring of a theory, the well-constructed composition of a picture or a piece of music. Because it refers to something specifically architectural, and in contrast to the non-architectural cases in which the term is also used, clearly, it refers to a necessary and essential feature in the case of architecture. Only structures that manifest this feature should be regarded as genuinely architectural. Such structures go beyond building as a technical undertaking in particular by virtue of the way in which the systematic interplay between part and whole is communicated to our senses coherently (> readability). By bringing the existing structural > order to > expression by means of its architectural design, it fulfils a precondition for providing intellectual satisfaction. A higher level of expectation would

even call on architecture to render the world graspable via the medium of its spatial structuring.

3. Architecture is not restricted to the erection of buildings, but conditions our habitation of spaces, and shapes our experience in relation to them. Architecture allows spatial > situations to emerge that are equipped with > atmospheres, and that we experience with all of our senses, as well as through the interplay between constructive-spatial properties and our bodily movements, our activity as users, and our mental states. In contrast to the objective reality that is attributed to a building as a mere object, and differently from the ideal reality of a pictorial work of art, the situative reality of architecture as I perceive it is at the same time my subjective reality. In a performative act, we experience our interaction with space – including its practical > use – from a self-referential perspective – if often only subliminally. It is tempting to draw a parallel with a > scene in a theatre. We watch ourselves during our activities in a spatial framework designed for this purpose, or become aware of them incidentally. But unlike a performance with actors and audience, we are simultaneously actors and onlookers. We experience the spatial relationships described above – including those between body and space, interior and exterior, place and movement, as well as the structural order of the whole – as situations in which we ourselves play active parts.

Architecture parlante

> image, readability

Arrival

> dramaturgy, ingress and exit, intermediate space, introduction, route

Ascent

To experience one's own body with intensity while ascending constitutes a very special form of enjoyment. One must exert oneself, lift one's own body, maintain equilibrium, and avoid falling. But our efforts are rewarded when we reach an

elevated place. The magical attractiveness of heights seems to be an anthropological constant. As soon as children learn to walk, they attempt to conquer space vertically as well, and climb whenever they have the chance. While spatial experience relates mainly to plane surfaces (> ground), climbing and descending form an extended sense of spatiality, as we traverse space in all directions simultaneously, both vertically and horizontally. In ascending, we reach new > levels, gain new perspectives and new possibilities that were previously unavailable, whether visually or motorically.

A hierarchy or graduated order extending from upper to lower is a general and deeply rooted cultural and social structural principle. According to its laws, the positive value, i.e. that which is weightier, worthier, more powerful, holier, is always located above, where moreover the light is brighter. We ascend to a higher point from the darker, earthier lowlands. Regarded in dramaturgical terms, such ascent often involves a heightening of significance. The prospect of attaining a new elevation awakens very special expectations. Arrival resembles a triumph or liberation, the overview it offers makes possible new prospects. We are familiar with such experiences from mountains or hills, their high points often marked by lookout points, chapels, castles or summit crosses. Temples are often set upon pedestals, so that one approaches them from below, entering the sanctuary only after ascending a staircase step by step. Some cult sites even consist primarily of structures designed for ascent, including the Babylonian ziggurats whose summits are approached by circling a centre. Power and majesty reside above, with commanding views and opportunities for control, while those who are subject to authority wait below, gazing upwards.

In residences, one ascends to the private rooms above, at least where the distinction between daytime and nighttime activities is articulated by a division into storeys, as recommended by Adolf Loos. Above, the setting for bedrooms or private workrooms, withdrawal and seclusion are generally

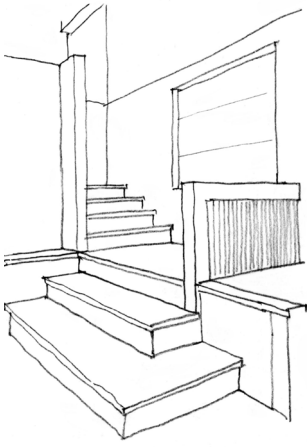

associated with greater intimacy. Sharp divisions between storeys are avoided, especially where they are overcome through the distribution of short, separate staircase segments that are distributed throughout the house, effecting an almost imperceptible, effortless ascent, as attained by Loos through his > Raumplan principle. Gaston Bachelard remarked that the form of ascent is also an anticipation of the place towards which it leads, the > steps to the basement always lead downward, those to the attic always upward.

Ascent proceeds slowly and with effort, because at least the weight of one's own body must be conquered step by step, while the increased weight load also intensifies the contact between feet and ground. This is the source of the heroic sensation involved in meeting the challenge of overcoming one's own weight, of winning a new freedom in the heights. To climb upwards and to arrive at a goal involves a sequence of effortful ascent and triumphantly propulsive movement. An extended, steep climb, in contrast, for example in a tall > tower, can produce the impression of arriving at a lonely place, perhaps associated with the approach of danger and vertigo.

When descending, in contrast, one's weight must be repeatedly absorbed and cushioned in small falling movements. The body relaxes in order to fall, then tenses itself to absorb the drop, a process that is repeated from step to step rhythmically in a way that is adapted to the rhythm of the staircase. With a resonant staircase, a wooden one for example, this is reinforced by the percussive sounds of our steps. Both negative and positive connotations are associated with descent. It means a loss of elevation, but also implications of disburdening, the relief of arrival: the ground receives me again, and offers possibilities for extension and movement, while that which is set in the heights (mountaintop, tower) is always much narrower than the plane upon which it stands. Through the sometimes unsuspected > entrances of others, the space one reaches via descent involuntarily acquires a theatrical dimension.

The type of ascent depends upon the length, breadth and changes of direction of ramps or staircases, their slopes and materials, as well as their straight or curved forms. Our style of gait, posture and sensations when climbing are also influenced by the number and position of landings and the configuration of the accompanying banisters and handrails. These may suggest rapid ascent or a dignified tread: shallower steps replace exertion with a delight in movement, while steep staircases compel us to climb; narrow spiral staircases, meanwhile, require us to wind our way upwards. Natural or artificial slopes require a special type of ascent. With the blurring of levels through 'hilly' modelling, as in the flooring of the Rolex Learning Center by SANAA, differences in elevations vanish, allowing the gaze to wander through a landscape. At the same time, steep areas, because they render our footing insecure, elicit a more intensive contact with the ground, and may induce us to take a seat.

When ascending a staircase, we move in an > intermediate space, having abandoned one level without having yet reached a new one. The ambivalence of this process is displayed in a different form in the place-changing immobility of an elevator; in the closed cabin, movement is essentially only virtual in character. A contrast is found in the characteristic movement on a ramp. Because we need not attend to the presence of steps while ascending, we are free to look around us. In addition, the necessarily extended length of the route, its sweep and expansiveness, converts it into a promenade. Effortlessly, on the other hand, and with a gentle whirring, an escalator carries us along like a transportable object, primarily passive and moving in an irreversible direction.

Literature: Giersch 1983; Mäckler 2009; Meisenheimer 1983

Assembly

> composition, detail, spatial structure, structure

Atmosphere

Architecture is experienced primarily through the atmospheres it generates. What surrounds us in a work of architecture is not just a building, with its structural and spatial forms, but also the atmosphere of a total > situation. A landscape is endowed with an atmospheric identity, and a town is not simply subdivided into a sequence of buildings or streets, but even more so into characteristic atmospheres; and the transition between interior and exterior spaces, or between individual interior rooms, is also a transition between contrasting atmospheres.

An atmosphere is the expressive force through which a situation that has been engendered by architecture seizes us in affective terms all at once and as a totality. In contrast, the expression of individual contributory forms, its > form character, comes into effect initially only through the total atmosphere of the situation; their impact is secondary.

Atmospheres form a peculiar relationship between object and subject. On the one hand, they have their points of departure in special situations and their elements; on the other, they are characters that condition our own mental states, and which we experience in principle subjectively, even when we share them with others. We may perceive atmospheres consciously, but we are particularly receptive to them in states of undirected attentiveness. There exists no specialized sensory organ for perceiving spatial atmospheres, for they are not seen, heard or tasted, but instead sensed bodily in an all-inclusive way; we are submerged in them and moved by their character or mood. It can also occur, however, that we find our own frame of mind to be opposed to a spatial atmosphere we encounter in a specific situation, one with which we have no desire to engage. Of course, we sense this atmosphere as clearly as ever, but we experience it in opposition to our own mental states as tension.

The following types of spatial atmospheres are the most common: the dynamic aspect of spatial > gesture shapes a situation, which potentially makes an impression of being

constrictive or oppressive, spacious or expansive, elevating or uplifting. The > orientation through which a space turns inward, outward, or towards a goal is often a component of this gestural expression. In many cases, sensory qualities shape atmospheric character through a synaesthetic transfer into the spatial dimension, and a situation is perceived, for example, as rough or frosty, shrill or muffled, stuffy or fresh. Atmospheric qualities such as the melancholic, heroic, cosy or festive do not express ostensibly spatial qualities, but are characteristic of spatial situations in many instances. Through the suggestive character of > appeals, which allow us to perceive the atmosphere of a situation as inviting or seductive or as repellent and hostile, we are directly influenced in our behaviour, and a response is demanded of us. Appeals are related to the > invitation character through which a situation prompts us to engage in a specific behaviour or action, such as sitting down or falling silent. Through metaphors and pictorial or symbolic allusions, atmospheres become indirectly animate. When, for example, the corresponding forms and details summon a militaristic or countrified, a noble or unserious impression, we sense the atmosphere immediately, without having to interpret it in relation to a situation; things are similar with the atmosphere of a geographic region, epoch or stylistic tendency, or a milieu whose effect is exotic, Oriental, medieval or Victorian. In many cases, the above-named categories are mixed, for example gestural and sensory qualities, or a metaphor with specific moods.



Nearly all of the perceptible elements of architecture participate in generating atmosphere. Alongside the location, > size and form of buildings and rooms, it is > surfaces that have particularly powerful atmospheric effects. In architecture, according to Gottfried Semper (1860–1863/2004), it is the > coverings of spatial delimitations and decorative layers that shape ‘genuine atmosphere’. Through both sensuous and associative effects, the contributing > materiality plays an important role. Equally decisive atmospheric components are

the nonmaterial factors of > sound, > aroma, and in particular > light and > darkness. As expressions of total situations, however, atmospheres are also generated through use, and through our knowledge of places. Attunement to atmospheres is a characteristic trait of every space, and is never entirely neutral.

As a concrete architectural example, Gernot Böhme characterizes a sacred atmosphere and the elements that generate it. Among these is a form of twilight effect, which is not diffused into the distance, as it is outside, but is delimited by the space, and surrounds those who are present. In this ‘sacred’ twilight, one senses something hidden, invisible, especially when enigmatic glimmers flare up in the darkness. At times, this twilight effect rises upwards, illuminated by a glow of light of uncertain origin that allows isolated objects to emerge from the darkness. By virtue of the soaring gesture of their spatial forms, the tall interiors of Gothic cathedrals generate a dynamism, the unfamiliar dimensions of which overwhelm those who enter. The > sublime thereby contributes to the sacred atmosphere, where the ‘slipping of bodily feeling into the infinite’ alternates with a sense of ‘being thrown back upon one’s own corporeality’ (Böhme 1998, 97). This sensation is amalgamated with the stillness, which becomes acutely perceptible through the echoing sound of one’s own footsteps, allowing one to experience one’s own ‘lostness in space’. Some might describe this experience rather as a feeling of security.

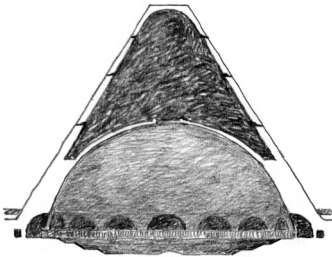

Like the sacred, many other types of atmospheric effects – such as those of a library, kindergarten, or railway station – can be characterized in terms of contributory factors. Since atmospheres depend on total situations, they cannot be entirely controlled by architectural means, but can nonetheless be substantially influenced by them. This is also the basis of techniques of manipulation deployed for the purposes of suggestion by an entire spectrum of advertising strategies, including city marketing, shopping mall design, and trade fair architecture. Such affective forces can be usurped for ulterior

purposes, at which point the generation of atmospheres becomes an exercise of power.

Literature: Böhme 1995a, 1998, 2006

- Atrium > centring courtyard, inversion
- Attitude > postures
- Attunement > appeal, atmosphere
- Axiality > axis, body (human), symmetry

Axis

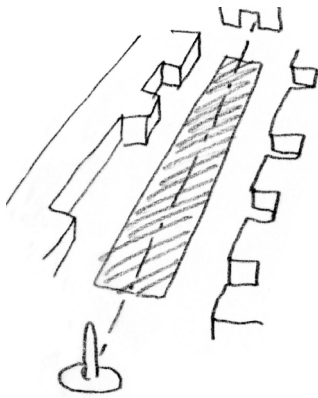

When spaces or architectural masses are arrayed on each side of the straight, central ordering line, which is generally marked by an initial element and/or by a concluding principal element, this line is referred to as an axis, and its termini as poles. By virtue of the strictness of the correspondence between an initial point and a remote terminus, and of the symmetrical arrangement of the flanking elements, the organizational principle of axial layout strives – both at the scale of the building, as well as in the wider urban context – towards a dominant ordering effect in relation to which the individual irregularities introduced by the spaces or buildings arrayed along it are subordinated. This effect is supported and reinforced by the shaping of the axis itself, as well as by the preservation of open spaces or surfaces, and by other types of emphasis – including, for example, rows of columns, promenades, bodies of water, or the creation of a homogenous field that is traversed by the axis. The poles are stressed by special spatial features, objects or buildings. The contrast between affiliation and physical distance joins the initial point and its remote terminus in a larger spatial tension. Through the open spaces along the axis and the link to a goal, a stepwise approach becomes a scenically charged progression of movement towards a destination, growing progressively in importance.

With its tendency towards monumental effects, the hierarchical relationship between lateral flanks and dominant

poles, and the gradual processes of approach or distancing that can be experienced here across wide expanses, this principle is often deployed as a means of heightening spatial movement in the context of orchestrating religious or political rituals (> monument).

In town planning, the axial principle makes it possible to create special kinds of spatial relationships. If the poles are regarded as destinations, axial relationships within a town (of the Baroque era, for example) serve the large-scale organization of space and of > routes, and provide > orientation in relation to important locations or facilitate approaches towards them. As regional networks, they extend beyond the town limits. View axes in landscape architecture – i.e. the English landscape park – have a similar function. Here, a dramaturgical network of unexpected, albeit highly calculated, links is spread out across the seemingly natural, irregular park landscape by means of the planned and sudden emergence into visibility of remote objects.

The concept of the axis has a variety of additional meanings: an axial order based on the tension between poles should be distinguished from the principle of axial symmetry as the articulation of spaces and planar or three-dimensional structural forms via mirror symmetry (> symmetry). The term *axis* can also refer to the axial subdivision of buildings and the constructive organization of rows and grids. As a system of spatial axes of coordination, finally, the bodily schema above/below, right/left and front/back constitutes the framework for > the movement and orientation of the human > body.

Balance

> composition, force field, heaviness and lightness, order, sensory perception, symmetry

Balcony

> facade, gallery, ingress and exit, intermediate space, view into/out of

Base

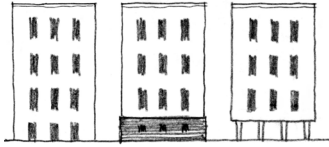

By virtue of their spatial connection to the terrain and the necessity for secure foundations, works of architecture differ from objects that can be inverted or carried away. The bottom edge, where a building rests on the ground, requires a different treatment than all other edges and surfaces (> tectonics). The base reveals the relationship between a building and the ground: it pushes into the earth, rests on the ground, or is detached from it. Whether a building makes the impression of standing upright, reclining or floating depends upon whether it has a base, and if so on its formation. The connection between the building and the ground also determines the way in which the building relates to the terrain of the exterior space and how the two join together to form a spatial unity.

Depending upon its design, the base shows us how a building rests upon the > ground. Solidity and robustness produce a tectonic expression of load-bearing capacity. Particularly in historic buildings, these qualities are achieved by means of rough rusticated masonry or the use of natural stone in the pedestal zone, or by squat proportions and apertures smaller than those in upper storeys. Bases also ensure that individual architectural elements, such as > columns and pillars, neither sink into the earth optically nor seem detached from it.

Although the base belongs to the building, and not to the earth, it fulfils the task of creating a connection to the terrain, broadening out by means of transitions, steps, pedestals or terraces. In ways comparable to the shoes we wear on our feet, materials also convey distinctions between the fineness of the interior and the coarseness of the exterior. Along with the building, the base also brings its occupants down to earth, shaping direct contact with the passersby and vehicles that move around the building.

Through its palpable presence and tactile qualities, the base constitutes the first zone of contact for approaching a building within its immediate surroundings, and is its first distinctive identifying symbol. Essentially, it is reminiscent of the role of the pedestal, which provided stability to ancient

temples as the first islands of civilization within inaccessible terrain.

Under certain circumstances, the task of the base, namely to provide stability and an optical foundation, may be extended by its use as a basement storey. With reduced apertures, the rooms contained in the base are partially inserted into the ground. The unfortunately widespread bad habit, however, of digging out the base in order to provide living space with improved illumination deprives a building of stable grounding. The mental state of the inhabitant of a massive basement storey that serves a building as a base, on the other hand, is shaped by a sense of the apartment's anchoring into the ground.

Basement

> ascent, base, cellar, intermediate space

Bathroom

> furnishing

Bay window

> intermediate space, space-containing wall

Beauty

We encounter the beautiful in architecture not only through beautiful forms, but also in relation to total situations. The aesthetic qualities of architectural forms are embedded in our performative interactions with them. Conceived as aesthetics (from the Greek word *αἴσθησις*, *aisthesis*, meaning 'perception'), i.e. understood as a general doctrine of perception, an aesthetic of architecture examines the way in which we perceive and experience (> sensory perception, > experience) architecture. But in contradistinction to predicates from the realm of sensuous perception, i.e. clarity, variety, sensory stimulation, and from the intellectual appraisal of qualities such as regularity or authenticity, beauty is a matter of pleasure for its own sake. We encounter the beautiful in architecture when we regard it from a specifically aesthetic perspective, with a concentration on phenomenal concreteness, without leaping past this level immediately towards functional reality (Böhme

2001). In aesthetic experience, the percipient is not classified conceptually ‘as something’; instead, it is experienced in its self-sufficient specificity, its distinctiveness, within the plenitude of its characteristics (Seel 2000). Immanuel Kant defined beauty as a pleasing quality of perceptual experience that pleases us without stimulating desire. According to Kant, it is a subjective judgement. But this subjective judgement is no solitary affair; it can claim validity for at least some other individuals.

Continual attempts have been made to determine the formal preconditions for architecture using the criteria of beauty. Not unlike the way in which Vitruvius sought support for the concept of *venustas* (loveliness or beauty) in the characteristics of proportion and order, Leon Battista Alberti grounded architectural beauty in *concinnitas*, meaning the correct number, relationship and arrangement of the members of the building. From Alberti’s celebrated definition, we learned that when a building conforms to *concinnitas*, nothing can be added to it or taken away from it without destroying the whole. For Alberti, *concinnitas* is the essence of natural perfection, a totality whose harmonious equilibrium is opposed by a precarious fragility. While French architectural theory of the grand siècle located the foundations of architectural beauty in the rational comprehensibility of a composition, the functionalist approach demanded a correspondence between an architectural object’s appearance and its essence. Correspondingly, beauty was held to be ‘the brilliance of truth’ (St Augustine), and was attained not solely by virtue of a form expressing function, but only through the manifest perfection of this expression. Since divergent factors must be continually united with one another in architecture, its success can be traced back to the contrast and balance of opposites in a way analogous to Heraclitus’ *παλίντροπος ἄρμονίη* (*palintropos harmonië*): ‘The unlike is joined together, and from differences results the most beautiful harmony.’ (Heraclitus 1889, fragm. 8) The art of fusing antagonistic demands, multiplicity

together with regularity, originality with familiarity, and complexity with order, counts as a continually recurring condition of beauty. And yet precisely that which idiosyncratically evades all preconceived criteria may nonetheless be perceived as beautiful. It is not primarily a question of deciding for a specific concept of beauty through which one plays off, for example, perfection against the unremarkable (> patina), or a traditional order such as that of the 'European city' against the disordered multiplicity of the 'in-between city' (Sieverts 2003).

One need not search for the beauty of architecture solely in its forms, although this is the familiar perspective. As used by us in actual situations on a daily basis, architectural forms do not play the primary role. In order to grasp architecture adequately in aesthetic terms, we must not just consider buildings or architectural forms, but instead allow the concrete experience of living in a certain town or in a certain house to affect us overall. In such contexts, we are exposed to spatial complexity and atmosphere, we move and interact, our state of mind as a whole is affected. When we adopt an aesthetic perspective of a situation, avoid reducing it to its practical function, and surrender to it with all of our senses, then our experience of that situation as such becomes an object of aesthetic experience. This may also reincorporate purposeful action (Frey 1925/1946). The experience of beauty is engendered when we savour an architectural situation with relish and enjoy it scenically (> scene). When we perceive the beautiful, the aesthetic and formal traits of a city or building are incorporated into this process. We encounter the beauty of Mies van der Rohe's Barcelona Pavilion, for example, not primarily by contemplating its proportions, material effects, vistas or lighting scheme, but through the self-referential experience of purposeless, relaxed movement, and the dissolution of boundaries within the spatial forms.

Bed

> furnishing, ground, inside and outside

Body, architectural

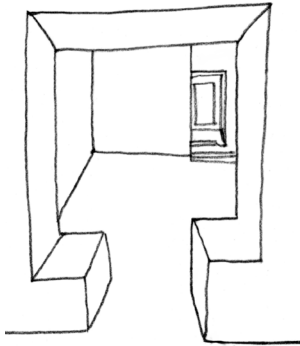

Throughout much of history, the principal task of architecture was to erect and design body-like objects; only much later would shaping of spaces assume priority. Even Heinrich Wölfflin (1886/1999) continued to characterize architecture as an ‘art of bodily masses’. In architecture, bodies are the complements of space. This is only indirectly perceptible, while it is bodies – with their various forms, openings and arrangements, in the form of walls, wall slabs, supports and architectural volumes, all the way to the urban block and the ‘corpus of the city’ – that we see and feel with immediacy, that guide our movements. Architectural planes are also the > surfaces of – often quite thin – bodies.

The complementary relation between bodies and space is among the constitutive interdependencies in/of architecture. Albert Erich Brinckmann could characterize architecture as a ‘spatio-plastic art’ because spatial and plastic forms condition one another reciprocally, and spatial experience results from the experience of bodies. As Hans van der Laan has shown, a space can only appear as a form ‘by borrowing its surface from a solid body’. The wall of an interior is the surface of a body, which becomes visible when the wall is perforated, so that its thickness becomes perceptible. A space that is delimited only by planes seems comparatively un-sculptural and abstract; it is not perceived as an interior, as a counterpart to a body, which is why caves lack essential architectural features (Van der Laan 1983).

Body and space stand in a figure/ground relationship – both within the building and in the > context of the urban totality. A body is surrounded and bounded by empty space. Conversely, a space – such as a room or public square – is contoured, framed and formed by architectural masses. Its surface is the exterior of an architectural mass, and at the same time, the interior of a space. Often, the body-like mass itself contains space. As a hollow container, it makes an impression of solidity only from the outside, while as a > poché, it is primarily a balancing mass, and is often interspersed by

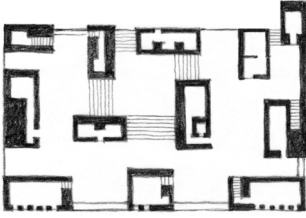

the > porousness of ancillary rooms as though by caverns. Through a > space/body continuum, architectural bodies mediate between two types of spaces, for they contain interiors while shaping exterior spaces. For the sake of the amenity qualities of urban spaces in particular, it is vital that architectural bodies participate in framing spaces, that they are not simply set off from one another as solitaires. Only above a certain height do the spatial intervals between buildings play no significant role, so that towers and high-rises are experienced primarily as three-dimensional bodies.

Given sufficient space, architectural bodies cast > space shadows, thereby generating zones of influence around themselves that are characterized by forces of repulsion and attraction. As a result, the spaces between architectural bodies in urban settings appear either compressed or expanded: narrow intervals generate pressure between bodies, while such space-shaping force loses its effectiveness when the distance between buildings grows too large. Because we have bodies, and move with them through space, a confrontation between our own bodies and architectural bodies is an immediate and concrete experience (> body). We perceive pressure, density, resistance and weight in direct haptic contact with buildings, and tensions and forces as well through the perception of virtual > force fields. The sensation of passing between thick walls transforms the transition from one room to the next into the overcoming of resistance. Plastically articulated and graduated bodies endow space with > depth. A space that is occupied and dominated by three-dimensional masses is characterized by a different level of tension from one that is delimited by non-corporeal boundaries, lines, or by plane surfaces (> field).



From a perspective that is more pictorial than architectural, finally, architectural bodies may be regarded primarily as sculptures. Here, it is a question of formal qualities such as the balancing of contradictory orientations and of (dynamic) equilibrium, of the contrasting composition of large and small

elements and hollow volumes, or of endowing a building with an impression of weightlessness. For the most part, it is the external form of an architectural body that stands in the foreground; it aims towards a certain expressiveness through its > form character, or functions as symbolically (> symbol) in relation to a signal value. In many cases, a building is positioned in such a way that it is visible and can be circumambulated from all sides, while its relationship to the context and to the shaping of an inviting urban space is neglected. The building's plasticity and sculptural qualities, however, would be well-adapted to the shaping and articulating of the surrounding space as a formal counterpart.

Literature: Brinckmann 1924; Kemp 2009; Van der Laan 1983

Body, human

For our perceptions and experience of spatial situations, the human body is indispensable to such an extent that 'there would be no space for me at all if I had no body' (Merleau-Ponty 1962, 102). My own body is something radically different from other bodies in the sense that I experience and feel it as being mine, as me. Through my body, I move and act; through it, I also experience space; it integrates my various sensory perceptions. Other bodies, by contrast, are reduced to objects, are regarded only outwardly. The German language makes a clear distinction between Leib (the human body) and Körper (physical bodies in general), so that it is possible to say in German: 'Leib bin ich – Körper habe ich' – meaning: the body [Körper, i.e. physical object] I have, the body [Leib, i.e. the experiential, corporeal body] I am) (Dürckheim, 2005). Since every human being experiences his or her body in this way, the experience of corporeality is an intersubjective phenomenon.

My body occupies space; it does not end at the surface of my skin, however, but extends via my clothing (we say: I stand on the floor, not: I stand on my socks), or through

implements, things, including walking sticks, spectacles, the compartment of a vehicle, the interior of a house. For Merleau-Ponty, the boundaries between the human body and the external physical world are indistinct to such an extent that 'it [my body] holds things in a circle around itself. Things ... are encrusted in its flesh, they are part of its full definition; the world is made of the very stuff of the body.' (1961/1993, 125)

The corporeal sphere also requires space for our movements and our radius of action, and this zone forms the core of our > personal space. Every situation is constituted for us on this basis; the human body is anchored in the objectivity and spatiality of architecture.

The spatial disposition of the human body is structured according to a schema that is consistent with the three spatial axes. The vertical axis corresponds to the upright posture of the body, which follows gravity as an immutable alignment, hence ensuring orientation in relation to the ground plane; it forms the symmetrical axis for the pair-wise arrangement of bodily organs and limbs in the horizontal direction; the horizontal depth axis corresponds to the primary direction of movement and of the gaze. The resultant zero point of > centring is, to be sure, the point of departure and reference for spatial perception, but is however relativized by orientation towards other spatial centres. We perceive the middle of a room as the centre from which we experience it, even if we do not stand inside it; the same is true of the middle of a public square viewed from a window. The zero point wanders with the gaze. 'Functioning as immediately centring is the goal of experience, not its point of departure. And in relation to this goal, the body is experienced in the corresponding perspective.' (Holenstein 1985, 35)

Through corporeal conditionality, we perceive spaces in a specific way. Our eyes are set in front and our feet favour forward locomotion, resulting in highly specific forms of movement in space. Spatial sequences are staggered in a linear fashion as a series of imminent, anticipated steps. Centralized

spaces suggest > oscillation, since our eyes are incapable of circumferential vision. The dividing character of certain wall heights is conditioned by eye height as a critical limit. Because we are never free of the ground plane, we live primarily in relation to walls; we cannot see the space in plan. What we require if we are to grasp a complex > spatial structure is spatial > memory. The body too possesses a memory. Through it, figures of movement are internalized as they are performed, and are recalled later, i.e. the contours of routes or the configurations of staircases. We measure the slope of a staircase not with a tape measure, but with our steps. We judge the heaviness of the door not by its actual weight, but through the resistance it offers to our physical effort. We ascertain the design of a door handle by grasping it. The haptic and spatial properties of forms are evaluated and interpreted through a pre-reflexive synchronization with one's own corporeality. Moreover, the way in which space appears to us is influenced by our > posture and > movement: we experience it differently when walking than when sitting or standing, and entirely differently when reclining. Kinaesthetic sensations received through the body condition every perception.

Our perceptions of our spatial surroundings must be regarded as a form of corporeal > expansiveness. The corporeal sphere expands all the way to objects, and into the depths of the surrounding space. We project our bodies into the architectural forms that stand before us, into their recesses, projections and openings. The body is the basis of the operations of > empathy in relation to built forms, for example when we experience the form of a bulging column in relation to a sense of pressure felt in our own bodies. Through empathy, architecture is so to speak imbued with life, at least when we perceive it as expressing specific bodily conditions in ways that correspond to our own bodily sensations.

Literature: Holenstein 1985; Meisenheimer 2004; Merleau-Ponty 1961/1993, 1962

Boundary > door and gate, inside and outside, intermediate space, screening, surface, territory, threshold, wall
Brightness > comfortableness, darkness, light, sublimity
Buffer > covering, intermediate space, poché, resonance space, space shadow
Building > architecture, expression, meaning, materiality, tectonics

Cabinet > furnishing

Capacity Alongside its quantitative meaning, the concept of capacity has a qualitative one as well, and refers to receptiveness to characteristics, > meanings and tasks. From a contemporary perspective, one example of functional capacity in architecture is the apartment of the Wilhelminian era. In terms of layout and gestalt, it displays an incisive character and offers a generous space with multifarious qualities for use in everyday life. As a consequence, it is neither expressively neutral nor functionally determined in a constricting way. It can be used by families, for apartment shares, or as an office. It can be furnished ostentatiously or chaotically, sparingly or lavishly. The fact that former factory buildings are so well-suited to serving as galleries or museums of modern art is attributable not just to their flexible spatial arrangements and large dimensions, but also to the restrained design so typical of industrial architecture. Their often plain yet characteristic aesthetic traits make them attractive as the offices and studios of advertising agencies, designers, or other disciplines. Here, the architecture's functional capacity suggests types of use different from those characteristic of the Wilhelminian apartment, but in both cases (and one could easily add further examples), two factors work together: the way in which the space is handled is conditioned by its characteristic idiosyncrasies, as well as by its openness to a wide range of forms of specific > use. Spaces with functional capacity are adaptable to many,

but not all functions. They do not limit the possibilities in the sense of typical use schemes, but according to particular tendencies; through design, structure of movement, and atmosphere, they endow every use with a specific character, giving meaning to deviations.

Christian Norberg-Schulz has referred to the fact that ‘the forms possess symbolizing capacities, but they become active and real only through a semantical correlation with building tasks.’ (1963, 176–177) With the concept of ‘semantic capacity’, Bernhard Schneider has claimed a role for architecture that cannot be fulfilled by semantically neutral architecture. For when systems are semantically empty, they generate only the ‘noise’ of aesthetic arbitrariness. On the contrary, an architecture that accommodates the user’s acts of appropriation calls for a high degree of aesthetic complexity. Semantic capacity, then, refers to the potential of architecture to endow everyday practice with > meaning under changing conditions, and to absorb meaning into itself. An architecture that is thinned out to the level of neutral structures, however, cannot develop this potential. It would be erroneous to conclude that the less architecture is defined, the more open it is in relation to use. Precisely a characteristic architecture is necessary if contemporary interpretations are to be tolerated or elicited.

Although the term ‘capacity’ was first introduced into architecture via semiotics (> sign), the idea of capacity in architecture can be restricted neither to an accretion of meanings nor of practical uses. We do not experience architecture primarily by ‘reading’ meanings or ‘assigning’ functions; instead, we comprehend architectural reality through our corporeal involvement, through which the performative – or better, scenic – character of our dealings with architecture become explicit (> scene). The scenic capacity of architecture takes priority over its functional or semantic capacities. For the scenic experience of architecture as well, architecture does more than provide a neutral setting. Our movements, our dealings

with space, acquire value only when they are removed from monotony and triviality. An architectural framing of space can sensitize us to the value of our acts, and architecture has available to it the instruments suited to this purpose.

A ring of rooms around a covered walkway surrounding a garden courtyard is well adapted to use as a hotel, a student residence, a cloister, or a centre for craft activities. It is neither a neutral multipurpose structure nor functionally predetermined, but is suggestive of a specific dramaturgy for meeting, circulation and communication, providing characteristic scenic interpretations for all of the above-named uses. Junya Ishigami's filigree hall in Kanagawa also offers a broad spectrum of uses: for study, for exhibition, or for sauntering. Here, a specific interpretation of this spectrum of uses can be attained tellingly through the light screen of supports, one that creates a special scenic and atmospheric frame without generating diffuse neutrality.

The above-named traits attributed to architecture stand in a relationship of tension between substance and contingency that is defined as capacity. On the side of substance stand articulated spaces, dense > atmosphere, aesthetic > complexity, characteristic conditions of movement, in short: *Prägnanz*. On the side of contingency stand the performative act, openness, variability in use, displacements of meaning, which is to say: room for manoeuvre.

While architecture provides a repertoire of specific resources and structures, it is only through the performative process of actual activity that the striving for openness actually reveals itself as the capacity to encompass a multiplicity of possibilities for appropriation.

Literature: Hertzberger 1991; Janson/Wolfrum 2006

Casualness

> architecture, experience, scene

Ceiling

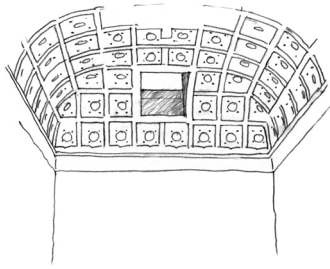

Within a building, the ceiling substitutes for the sky; outside, the sky forms a ceiling. We barely notice the sky unless attention is called towards it by its unusual appearance. Things are similar with the ceiling. While we are oriented in everyday life primarily towards walls, and secondly towards the floor, the ceiling is ignored for the most part unless it is made conspicuous by virtue of unusual height, coloration, or through apertures or other special features. This is also due to the fact that with ordinary room heights, the ceiling only enters our field of vision across large distances. In narrowly enclosed outdoor spaces, it makes little difference whether we stand beneath a ceiling or sky, while a cornice can suggest the presence of an imaginary ceiling, with a leaf canopy or trellises providing a certain degree of materialization. In large public squares, however, the angle of vision is wide enough to encompass the sky, towards which the squares open up.

The term *ceiling* is used in principle for a more or less horizontal terminus that is clearly delimited from the vertical boundaries of room, i.e. walls and supports. This distinction is more difficult to make, however, when the surface of the ceiling approaches the vertical gradually, reaching almost all the way to the floor, as in the case of cupolas, vaults, and the freely formed upper termini of rooms.

Even where the ceiling conveys the impression, either directly or indirectly, of being a > roof, the two are nonetheless not identical, since a ceiling is the interior of hollow space, while a roof is perceived as the outside of an architectural corpus. And where the roof and its construction are left naked and visible from the interior, the ceiling has a different effect as an interior cavity than it does in its function as the crowning upper terminus of a building.

While the walls of a room divide, the ceiling instead has a unifying and articulating function. It provides a completing upper covering for a room that has already been delimited, measured off, and shaped by its walls. It may also be regarded, however, as the primary element that satisfies the

primordial need for covering. In fact, a room can be defined without delimiting walls, for example, as a skeleton structure, solely by its contours, and its elevation defined by a ceiling panel; in this case, the roofed volume nonetheless appears as an interior, and the projection of the panel's contours onto the floor substitute for its delimitation by walls. The elevation of the ceiling and of the room adds a third dimension to the plan. While the plan is responsible primarily for organizing the > spatial structure, a room's expressive qualities are determined mainly by the combination of plan and elevation (and its variation).

Depending upon the social situation, our > personal space expands; it is smaller in intimate encounters, and occupies more space in public settings. In addition to the requisite surface area, the leeway for manoeuvring also requires an appropriate elevation. This corresponds to the fact that a low ceiling seems to bring voices and noises closer, while they seem further away beneath higher ones. Variations in ceiling height provide a differentiated range of rooms; those with lower ceilings are better suited to secluded situations, and taller ones correspond instead to more convivial activities. Attentive to such considerations, for example, is Adolph Loos's > Raumplan. A variation in room heights can also be achieved by raising the floor level in relation to the ceiling height, or by the installation of > galleries or platforms.

The atmospheric character of a room is dependent upon room height. Just as a very low ceiling may convey an impression of intimacy and security, but also of airless, smothering constriction, a very high ceiling may suggest spaciousness and festiveness, but may also evoke feelings of lostness. Associated with the variegated forms of the ceiling is a rich symbolism, for example, of the vault of heaven or the firmament, or of a grove of trees or ship's hold.

Although the ceiling is generally only noticed incidentally, a distinct shift in ceiling height or the introduction of a special form draws the gaze involuntarily upwards. The design of

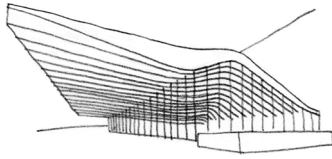

the ceiling is important in particular for the gestural character of a space. It elevates a space or presses it down, orients or centres it, unifies or articulates it. While a room with a flat roof extends uniformly and horizontally, one contained by the concave shell of a cupola rises upwards. The tranquil, containing effect of a rectilinear tunnel vault contrasts with the expressive, soaring > gesture of a Gothic vault with pointed arches. A concave ceiling form holds the space together, while the ceiling beneath a curving roof allows it to flow towards the outside, as in the Stazione Termini in Rome.

Under an open sky, the > light comes from above; when an opening in the ceiling admits light from above, it suggests, as an opening, either the supernatural origins of the zenithal light, or else it admits daylight to open up the room. In contrast, the ceiling seems to rise when light enters between the walls and ceiling, first, because the connecting support seem absent, and second because the raking light makes it appear lightweight; otherwise, ceilings nearly always lie in the shadow of the window lintels. A ceiling may also appear lighter and somewhat further away as a result of being painted pale blue, being given a textile 'tent sky', or through a dematerializing ceiling painting, especially when the heavens are depicted. Evoking associations with the nighttime or stormy skies, by contrast, are dark > colours, which make a ceiling seem heavy, generating effects that may seem either protective or oppressive. Between the roof as the building's uppermost delimitation and the ceiling below is often an > intermediate space that may have quite minimal dimensions, or may take the form of a large attic space, or anything in between. If the ceiling opens upwards towards it, then this dark attic space, with its open roof construction, becomes a > space of resonance. If it remains concealed, visitors nonetheless sense the presence of the space between ceiling and roof, about which they however know very little.

Cell

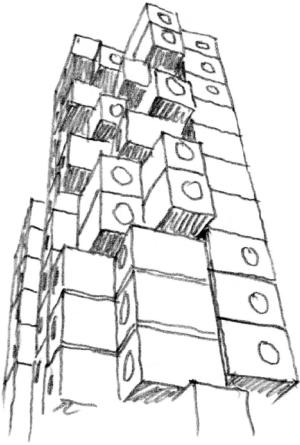

As the smallest habitable unit, the spatial cell is a materialized form of the individual sphere in two respects. First, it can be regarded as a form of the most intense spatial concentration within which the human individual fully controls his or her environment, equipping it with only the most necessary objects, and keeping everything he needs within reach. The immediate correspondence between spatial requirements and spatial delimitations makes the envelope a matrix within which the free spatial development of activities can leave their traces as imprint and self-expression without other influences. For people who wish to ensconce themselves as a response to a sense of insecurity caused by the strain of a confusing and threatening environment, for example, the cell functions as a retreat from the world. Cocooning like this in a private residence characterizes the general social trend of withdrawal into private life. The word's provenance from the Latin *celare*, to conceal, corresponds to such connotations of introversion. For biological cells as well, the cell walls are decisive, and a cell is always closed in relative terms towards the outside. Its relation to the outside is defined not by openings, but by an agglomeration of cellular units of similar design and dimensions. In architecture, this corresponds to the organization of capsule hotels, emergency accommodations, and holding or prison cells. In fact, the apparent sameness of cells often indicates the similarity of their functions or of user status.

The additive repetition of the identical is often applied as a principle of arrangement. In architecture, however, the individual cell is often extended and complemented by a collective counterpart intended for community use. Examples are cloisters, student residences, and ocean liners. On the one hand, cell or honeycomb structures arranged in uniform agglomerations without such complementarity express the egalitarian order of individual living spaces; on the other, they tend towards monotonous uniformity.

If we regard cells as the materialization of the distance zones investigated by American anthropologists, which peo-

ple claim as their personal spheres (bubbles), we could then speak of a foam composed of such individual bubbles. Architectural complexes with dense agglomerations have a kind of large-scale > porosity.

The potential of the cell for intensive spatial experience lies in an almost archaic self-limitation to a place where one is surrounded only by the essential, thereby excluding everything superfluous and avoiding all distraction (> simplicity). Enclosed by an envelope that is so to speak tailor-made to one's own body, it is possible to surrender to concentration of the kind required for contemplative, creative, or other intense activities. Examples are St Jerome's study and Le Corbusier's Cabanon. The cell is also well-adapted to focusing on specific functions that are generally reserved for the individual, and exclude everyone else. Envisioned for such purposes alongside the studiolo for intellectual labour is the sleeping cubicle, or bathroom or shower module. Bizarre exaggerations, meanwhile, were developed by radical architects during the 1960s, including space capsules, portable objects residing somewhere between apparatus and organ, where bodily functions such as heartbeat and respiration were to have been displaced to the envelope and connections with the exterior world maintained via supply tubes or telecommunication devices.

A special instance is found in those cells that isolate even as they are propelled through space. They are the interiors of cars, mobile homes, cable cars and lifts, which make it possible to adopt a position of rest while engaging in motion, to experience the contrast between change of location and stationary location within the cell. In this way, a fundamental problem of staying in the cell becomes clear: curtailment of the necessary freedom of movement and the constraint effected by space limitations. If compensation is not offered by the forward movement of the cell itself, then a balance can only be maintained by changes between various surroundings, which summon one another reciprocally: at some point, the narrowness of the cell evokes the desire for a wider space

within which we can stride, where the field of vision can expand. The diversity of open space, conversely, generates a desire for a space within which we can come to ourselves, can fully concentrate.

Cellar

Actually, the cellar is an impertinence. It seems to contradict that which we customarily expect from architectural structures. As a pure > inside, it is the place where the difference between outer and inner that is so fundamental for architecture collapses. Surrounded by the earth, the cellar is not accessed at ground level, but instead via a steep set of stairs. This circumstance also accords the cellar a fundamental role in anchoring the building into the earth (as expressed by the English word basement), reinforcing its stability and immovability while endowing it with an earthy side (> base). Gaston Bachelard refers to the vertical polarity of the house between roof and cellar: the rationality of the roof, its comprehensible form and construction, is opposed by the cellar, with its irrational side, as the 'dark essence of the house'. One climbs up to the attic, whereas one descends downward into the cellar, summoning associations with the heavens and the underworld.

Alongside the darkness, combated by means of artificial light or light shafts, and the sense of quiet produced by the far-reaching acoustic screening, we sense a direct proximity to the earth by virtue of a cool, moist, often musty or mouldy atmosphere. Our senses are sharpened by the quiet and the > darkness; we are acutely aware of shadows and sounds, and the cellar acquires an aura of mystery. Our sense of fantasy is aroused by the inscrutability of subterranean passageways, which may proliferate to encompass entire cities.

Because it lies below ground level, and hence has no outside, the cellar may engender claustrophobic atmospheres. There, since contact with the outside world is cut off, and the only escape to the outside lies above, the individual is thrown

back upon him- or herself. In fact, the cellar is not a space of everyday life, and those who spend substantial time there have special reasons for doing so. One either has something to hide, and the cellar is used for concealment, or as a place of crime (a torture chamber), one has ‘bodies in the basement’, or one varies oneself in order to lead a secluded private existence (the catacombs). The cellar also offers protection and security in the womb of the earth, as expressed by the form of vaulting, so evocative of caves; for this reason, it is also a place of internment (the crypt). The essence of the cellar is remote from the modern basement, which is not distinguished as a special place.

A certain normality of residence below ground, on the other hand, is offered by the basement apartment, albeit under special conditions. Set as a rule only partially below ground level (souterrain), it buries occupants only up to their necks, so to speak, in the earth. A view from the frog’s perspective grazes the ground, and is moreover oriented upwards, so that people and things are perceived from an inferior position in relation to the outer world. To go out means to ascend to the outside; upon returning home, one descends into one’s home as though into a cavern.

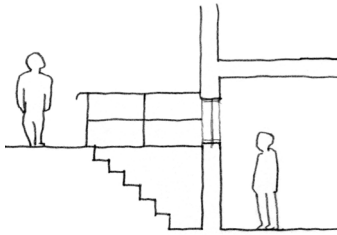

Traditionally, the cellar offered ideal conditions for storing and maturing edible products such as vegetables, cheese, sausage, wine and preserves. Prior to the use of the refrigerator, it was the only consistently cool storage space available. In this respect, and by virtue of its secluded character and its direct accessibility for the sake of the most various pleasures, it becomes the paradoxical antithesis of the one characterized above – a desolate place now becomes a cloistered land of milk and honey.

Central space

> centring, spatial structure, type

Centre

> centring, circulation

Centring

We are accustomed to defining an architectural space in terms of its boundaries (walls, enclosure), as being delimited from the continuous surrounding space and as deriving significance from this fact. It is also possible, however, to conceive of a space not in terms of boundaries, but as being conditioned by a centre. In the most primitive instance, a space is articulated by driving a post into the ground, becoming a centre that defines the immediate vicinity, which it divides into the area closest to it and the surrounding area. Rather than being an object, a centre can be a room that is surrounded by other rooms. The result is a centric > order of the > spatial structure, and of the corresponding possibilities for movement.

The emphasis on the centre and its importance corresponds to our conception of the centring of our spatial spheres around our own bodies (> body). We can experience a room from the centre, and experience its centring force, however, even when we are not contained by it. Elmar Holenstein has shown that the 'zero point of orientation' wanders with the gaze. The centre of a room or of a public square as the goal and centre of perception is also experienced as a centring force for one's own experience of self. The centre does not have to lie at the geometric centrepoint of the space; one example of this is the sitting area or breakfast nook as a place of > gathering.

Important alongside the centring of individual rooms is the centring of hierarchical arrangements of architectural elements, in particular of facades, which allow the central building of a larger complex with wings or of an extensive layout to emerge into special prominence, for example.

The experience of spatial situations, however, is particularly affected by the centring of rooms. The interiors of buildings based on centralized plans, which Leon Battista Alberti regarded as embodying ideal > beauty, are experienced in divergent ways. Cruciform or star forms lead radially towards the centre, while circles and octagons instead revolve around the centre concentrically. As long as the centre remains empty,

it exercises a pull; we feel uncertain there, and therefore returns to the periphery, only to turn back towards the middle again, so that perception and movement begin to oscillate (> oscillation) indecisively between periphery and centre. Only when certain elements or functions provide a focus does the centre become a prevailing attractor. From time immemorial, hearths (Latin: focus), altars and fountains have fulfilled this function. The same function, however, can be served by any element that attracts attention towards the centre or induces people to gather (> gathering) there, whether an exhibition object, or a table that has been shifted into the light for a common activity; in the latter case, we strive towards the centre, in the former, we orbit it (> circulation).

Spaces that are simultaneously centred and directional may be imbued with a double focus; examples are the two positions of an altar either in the chancel or in the (transept) crossing of a church. During the Baroque, special effects were derived from the fusion of elongated and centralized spaces. Notably, the enclosing structure is less conspicuous in spaces based on circular plans than in those with oval ones: in a circle, optical perception is so strongly compressed by perspectival foreshortening that the impression of enclosure is barely effective. When we enter a space with an oval plan along the long axis, the perspectival foreshortening in the lengthwise direction deforms it visually, causing it to appear as a circle; after a few steps, we feel strongly contained and constrained by the walls. Baroque architects such as Johann Michael Fischer employed these effects in their church buildings so that the nave enclosed the congregation, while along the lengthwise access, the altar seems to occupy the centre.

The total composition of the building and all of its rooms can be organized hierarchically around a main, central room, so that the character of the building as a whole emanates from this centralized position and its significance. Even where the centre recedes functionally behind the peripheral rooms as an 'empty middle', its latent spatial significance for the

whole remains palpable. In orientation, access and functional arrangement, these peripheral rooms are related in various ways to the centre. They either radiate outward centrifugally from a central interior space, or surround it concentrically. Accordingly, it is approached either via a radial or circulating movement.

The relationship of the central to the peripheral rooms may be based on an extension outward in a graded hierarchy that emerges from the centre in the form of far-flung and ramified spaces; or the surrounding spaces may be limited to a ring of subordinated peripheral zones, even reduced to the status of wall niches. Such 'ancillary' spaces heighten the introversion of the dominant space functionally. They may also serve as > space-containing walls or > resonance spaces, or as > intermediate spaces allowing a delayed transition, or even assume the mere task of a lining. If the subordinate spatial layer takes the form of a surrounding walkway, for example the colonnade of a peristyle, the act of stepping from it into the main space is accompanied by the feeling of being palpably enclosed by the surrounding layer. This sensation diminishes progressively during our inward trajectory, and the insecurity that emerges at the centre occasions the above-mentioned oscillation.

In the form of a staircase with main circulation hall, or simply a foyer, a central hall has the straightforward function of providing > access. But it also plays a role that is decisive for > orientation and communication within the building, one that is underscored further when it is emphasized by the design as a central courtyard with glazed roof. In a central atrium that is open to the sky, on the other hand, external space is transported into the centre of the building, which alternates in character between central inner and outer space (> courtyard). As an access courtyard, it is the nodal point of internal, intersecting or circulating streams of traffic, while as a garden courtyard, it forms the tranquil heart of the building, or a place of contemplation such as a cloister.

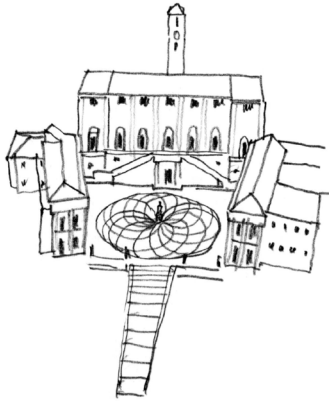

On an urban scale, the > public square assumes a centring function within a town or city. As the central point of a quarter or of a community as a whole, it is a point of orientation that bundles together routes and whose centre is traditionally identified by outstanding public buildings. Within an axial development, the centring function of a central space is also aligned along an > axis. Axes themselves constitute linear forms of centrality, and generally lead towards the centre of a space. As demonstrative figures of orientation, axes are linked to central spaces or squares in coherent gestures.

Ceremonial
Chair
Chora

> intermediate space, figure of movement, ritual, scene
> furnishing, postures
> body (architectural), space-body continuum

Circulation

The term *circulation* refers in general to the circuits of movement throughout the organism of the building. It encompasses the total flows through which > access is gained to the various parts of a building via staircases and routes. Circulation is hence a characteristic > figure of movement. By virtue of its constant progress, circulation is distinguished from a defined trajectory along a route with beginning and end, although it may display discontinuity and high points. Unlike the substantially free movement of > roaming, circulation is characterized by recurrence in ways analogous to various natural cycles such as the times of day or seasons of the year. And in contradistinction from the arc of tension that defines a > route from start to destination, circulation is characterized by continuity and supported by the anticipated repetition of numerous circuits. Such a periodic, potentially endless figure of movement, the kind performed in a cloister, for example, promotes the performance en route of discursive or contemplative activities. Related to circulation, then, is the oscillating movement that continually returns to itself rather than link-

ing to locations together like a route, i.e. an elongated stoa, or covered colonnade. Circular movements like the circumambulation of a sanctuary manifest this figure of movement as ritual action.

When a centring object that orients movement is circled, the varying form dynamic on different sides of the object may subdivide the movement into phases of gliding and deceleration, repulsion and attraction. A stroll through a city or a museum, in contrast, requires no centre. At times, the expansive empty middle of a room or square encourages the circling of an imaginary central point; on the other hand, the empty centre may constitute a point of attraction, promoting an > oscillation between centre and periphery. In the ring-shaped arrangement of rooms found in Leo von Klenze's Glyptothek in Munich, for example, circulation is circular. This type of arrangement is often encountered in apartments from the Wilhelminian era, where the possibility of reaching the same destination by at least two different routes, and hence the possibility of encountering or avoiding others, offers notable flexibility in use and differentiated experiential options.

Closure

Closure in architecture is manifested in a graduated way between absolute impermeability and complete openness. Degrees of closure are defined in a complementary fashion in relation to degrees of openness. Coexisting with requirements for enclosure is the need for balance through the requisite openness; only when views, movement, and accessibility have been restricted through closure can > openings indicate pathways in a directed way. Whether in urban development or in an individual building, closure and openness are experienced as 'part of this great environmental interplay between access and obstacle.' (Arnheim (1977/2009, 226).

In comparison to the 'open' > landscape, buildings in 'closed' localities, and even more so in closed developments, and to an increasing degree depending upon > density, con-

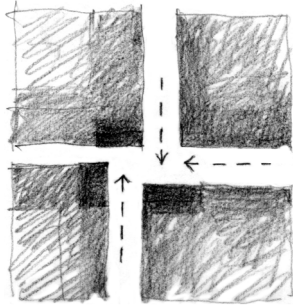

strict views and movement via canalization through intermediate spaces. The spaces of streets and public squares, finally, are contained by the closed fronts of buildings. Through a bend in the front level or a broken sight line in elevation, the street space closes itself off to perception longitudinally as well. The gaps in the corners of a public square seem closed when the streets flowing into it are arranged like the vanes of a windmill, blocking views to the outside (Sitté 1889/1983, 40f). If, however, the fronts of the square are open instead, a certain closure is nonetheless effected through the overall figure, since perceptual operations supplement it, filling in the missing fragments of the contour to form a complete > gestalt. In extreme instances, four corner houses suffice to produce the impression of a rectangular square. Chamfering the corners – an example being the Quadrivio delle Quattro Fontane in Rome – gives the figure a certain > concavity, contributing to a sense of closure.

The degree to which a square appears closed, meanwhile, is highly dependent upon the proportions between its overall surface and the height of the building fronts that contain it. When the head is held stationary, the > gaze as a rule takes in only a limited visual field. As a rule, the gaze reaches only up to the height that allows us to view the building fronts up to the level of the cornices when we gaze across a square that is twice the width of the building heights. Then the space of the square seems quite closed. If the width is three times the heights of the building fronts, a large section of the sky enters the picture, and the square begins to open up, yet still without losing its compactness. When the distance between buildings is between two and three times the average building height, an impression of closure and modest expanse prevails (Maertens 1877). Should the intervals between the containing buildings become too large, they no longer guarantee the cohesion of the figure of the square, and a sense of closure is sacrificed.

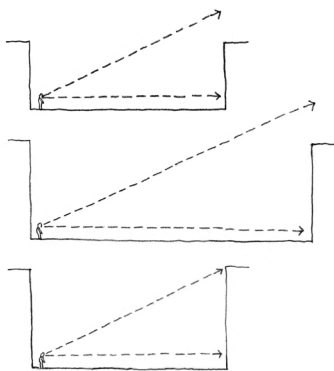

If it is to play off the contrast between a restrained outer appearance and the elaboration of the interior space within,

an individual building requires closed walls. The closed character of the > wall is also a precondition if the openings are to come into their own as the overcoming of division, i.e. by thematizing entrance and exit in the figures of door and window. The counterpart to closure is the openness of an architecture of > flowing space, which modulates the spatial continuum between > inside and outside by means of panels, slabs and posts, and which has no openings, but only gaps, intervals and interspaces.

But even when the spatial container has been dissolved a certain degree of boundedness is attainable. As a consequence of the laws of gestalt perception, rows of supports or > columns, for example, appear closed, as do the > arcades of a building front or the *brise-soleil* of a facade, especially when viewed obliquely. The > layering of perforated wall planes or the staggered arrangement of partitioning elements in alternation with apertures generates overlap effects, allowing a fragile closure to emerge. An interplay between closure and openness, blockage and access, generates an articulated transition between inside and outside.

Literature: Arnheim 1977/2009; Sitte 1889/1983

Code	> readability, sign
Cold	> warmth and cold
Collective memory	> memory, time
Colonnade	> arcade, column, courtyard, sequence

Colour

The intensity by which structures and the atmospheres of situations are marked by colour is no less decisive than the influence of built forms. Not unlike sound and odour, colour has an especially subliminal effect. To be sure, it is also effective associatively, primarily through expressive qualities that are actually attributable to colour itself, and which address us directly.

Beyond objective perceptual constants, coloration has a profound influence on the mood of a space; it can calm or stress, stimulate or add dramatic tension. Alongside immediate emotional values, colour often exercises an influence through > synaesthesia, and can generate impressions of warmth or cold, moistness or dryness, loudness or quietude. Colouristic effects such as the earthiness of brown tones or the airiness and expansiveness of pale blue may work via association. Cultural codes and the symbolic function of colour may be architecturally relevant, one example being the red carpet in Europe, traditionally associated with authority and dignity. On the other hand, there are no fundamentally ugly colours – we grow accustomed even to colours that are initially experienced as unpleasant. Ultimately, any colour contributes to the identification of a private room, district, city or landscape.

Differentiated colouristic effects are possible only under conditions of adequate illumination. In half-light, colours are greyed out, so that only light-dark contrasts remain perceptible. The dependency of colouristic effects on the colour of light is conditioned by the respective chromatic spectrum of the light source, for example through changing daylight under various weather conditions and times of year, by the directionality of light and by geographic latitudes, or by the absence of certain portions of the spectrum in artificial light sources, and is often influenced by filtered layers and reflections. The colour of the light affects the chromatic mood of entire spaces.

Individual elements, surfaces and bodies, meanwhile, are characterized by the local colours of materials or through the application of coloured layers. Colouristic effects are also influenced by the matt gloss, roughness or smoothness of a > surface: the sand-like colour of ochre is relatively ineffective for smooth surfaces, while yellow is less stimulating on coarse wall structures upon which raking light casts shadows. In addition, a colour has less intensity on a large surface than on a small one.

More important than the perception of an individual colour is the interaction between several colours present simultaneously in the same space. They influence one another reciprocally; complementary pairs, for example, produce effects of static equilibrium, while effects of simultaneous contrast cause the shadows of coloured surfaces to appear not colourless or grey, but tinged with the respective complementary value. All of these effects make it important to distinguish between the material properties of colours (local colour) and their actual chromatic effects.

Location is decisive for the spatial effect of colour. According to the investigations of the colour psychologist Heinrich Frieling, upon entering a room we attempt to establish a sense of stability in relation to the floor; a carpet in a powerful red or the natural colour of wooden floorboards will convey a greater sense of security than the distancing effect of blue linoleum, for example.

But the prevalent rule according to which red approaches and blue recedes does not always apply. In principle, this maxim is grounded in the physiology of vision, but like all straightforward equations of colours with effect, it nonetheless amounts to an impermissible simplification in relation to concrete experience. Not only are the reciprocal effects of various colours and other factors of ambience different in every situation; it must also be kept in mind that all reds, for example, are not equal: each has a different effect depending on hue, degree of lightness or darkness, and saturation. One red may appear restrained, another boisterous. Blue, by the same token, can cause space to expand, and even give it a distant and cold impression; a sky blue ceiling seems further away, while a darker blue screens it off, and can seem either heavy or protective.

Activities and the quality of time spent in a place can be enhanced by colour mood, not only when it dominates an entire room, as in the 'yellow hall' in Goethe's house in Weimar, whose colour, with its 'stimulating, lively, inspiring' ef-

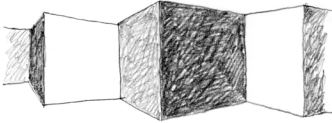
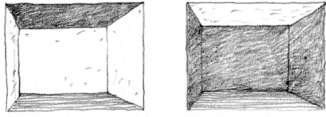

fects, was intended to promote conviviality at receptions or at mealtimes. Fundamentally, and in particular when it appears in saturated form, the dynamic and gestural impact of colour is decisive for architecture. It attracts or repels, elevates or weighs down, carries and leads us along through room sequences via widening, narrowing and effects of depth.

Uniform coloration emphasizes plastic unity, while the heterogeneous coloration of walls or other elements may cause structural elements to appear as an accumulation of individual elements. Linkages are affected, for example, by forming a > corner by giving a wall and ceiling the same or similar tones, thereby producing a containing effect. On the other hand, the convergence of contrasting coloured surfaces along the edges of a three-dimensional body may produce an optical disintegration. Walls or architectural elements, however, may be handled in such a way that they seem to have been cut out of coloured bodies. When the interior colour of the body contrasts visibly with its outside, an entrance, for example, may be reminiscent of the interior of a piece of fruit that has been sliced open. The spectrum of structural effects of coloration extends from the articulation and supporting clarification of the spatial complex, all the way to the extreme of a far-reaching fragmentation into self-sufficient coloured surfaces and individual coloured volumes.

Outside, colour can be decisive in throwing a building into relief against its surroundings, or integrating it into the > context. Decisive here is not only the coloration of the surrounding facades, i.e. where local building materials such as red Main Sandstone are used; the colour of the earth and that of vegetation in the vicinity also play a role. Essentially, colour makes it possible to establish large-scale spatial relationships. Many landscapes and townscape are shaped by the characteristic coloration of the architecture.

Literature: Frieling 1969; Meerwein et al. 2007

Column

Even a simple wooden staff stuck into the ground orders the space around it. A reply to the question: where does architecture begin? might well begin with reference to such a marker, which generates a centre. As a slender body, a post, stela, column, or other vertical standing element represents a counterpart to one's own upright body. As a one-dimensional demarcation, it already indicates the direction that leads towards or away from it, and can even convey the impression of a sphere of spatial influence into which one can enter as though into a room, only to exit from it again. Thus, architectural elements may appear in isolation (1), in pairs or groups of four (2), in rows or series (3), or columned hall (peristyle) (4).

1. Stakes, posts and stelae stand free, while pillars, shafts and stanchions support, in 'neutral' form, the load that rests on top of them. Unlike a support, a column is braced with its wide end below, at least in the Doric style, and swells towards the middle (entasis) before tapering above. Its form displays the effort of bearing weight, but is also perceptible as an independent striving upwards. The animate dynamism of active load bearing is sometimes visualized pictorially in columns that assume human form. Today, the column is a dignified form that alludes to tradition. In contrast to the rounded column, the pillar – with the four sides of a rectangular prism – establishes spatial relationships on all sides, and is hence able to respond to bodies or the fronts of walls.

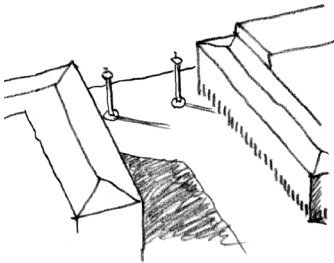

2. When two columns stand relatively close to one another, they define a vertical > plane that seems to be stretched out between them like a membrane. Where two columns frame a passageway, for example on the water side of the Piazzetta in Venice, they function like the pylons of a gateway. Configured as a square, columns demarcate the four edges of a cubic spatial volume, which we then perceive as a > gestalt, i.e. we supply its four sides in our imagination, easily grasping it as a spatial totality.

3. A row of columns represents a further development of the membrane stretched out between a pair of columns. Since

perception endows this form with continuity, Leon Battista Alberti referred to it as a dissolved > wall. As closed off as it may seem when viewed at an angle, it opens up when we draw close; as a wall, it is unapproachable. In contrast to the closed wall, a row of columns functions like a > filter, one that not only subdivides, but also expresses accessibility (> arcade). Its further dynamic impact is based on the repeated striving of each individual column. Their > row also suggests continuous forward momentum; the alternation between column and intercolumnar spacing accompanies and rhythmicizes a processional route in a basilica, for example, providing it with both stability and directionality. Despite their immobility, the arrayed columns seem to respond to our steps, 'it seems as though they move with us, as though we had awakened them to life' (Boullée 1987, 74). This dynamic effect is reinforced by the rhythm of light and shadow, by the gradual increase and reduction of brightness that is a function of the roundness of the columns, and which produces the effect of an undulating relief. Long rows of columns with many units and the narrowest intervals between them lead deep into the space and seem to increase its > size.

4. When a room is densely filled with columns, moreover, it seems unbounded, limitless. The impression of impenetrable > density is produced by the minimal intervals between columns, especially when they are configured in staggered rows (quincunx), and our gaze is unable to reach the boundaries of the space. This arrangement, reinforced by the roundness of the columns, invites us to penetrate the space in a curving trajectory that leads around the columns. Generally speaking, the type of movement adopted in a peristyle is a free, directionless > roaming even more so with larger intervals between the columns, which offer a sense of > expansiveness in place of impenetrability.

Alongside the columned porch (portico), the row of columns that forms a ring around a building (peristasis), and the framing of an interior courtyard by columns (peristyle), the

columned hall (or *hypostyle*, a Greek word meaning ‘to rest on columns’) is the building type that is shaped most strongly by the column. As a > hall with large dimensions whose very breadth requires the use of supports, whether columns or pillars, it presents as a public space. It is as though the columns had gathered themselves there, so that even in an empty hypostyle, one senses many other presences. In open halls with a uniform arrangement of columns, no particular direction is prescribed, which facilitates casual entry and unconstrained circulation. But even when it is closed to the outside, the hypostyle conveys an impression of imposing generosity.

By virtue of the affinity between the tree trunks and columns, a grove with regularly spaced trees – for example, the orange grove at the Mezquita in Córdoba – can be regarded as a transformation or anticipation of the hypostyle, whose columns, in turn, evoke the impression of fossilized trees.

Comfortableness

The German word *Behaglichkeit* – the rough equivalent of *comfortableness*, which also expresses a sense of physical contentedness – is derived from the word *Hag* (fenced enclosure), which referred originally to a section of the wilderness closed off for human use. The word *comfortableness* has similar implications of cosiness and physical security enjoyed in familiar surroundings.

The word *comfortableness* is primarily evocative of the immediate environment of a residence that has been arranged by an occupant. Basically, the preconditions under which comfortableness may be produced effectively include a multiplicity of individual factors and their interactions. Any restriction to putatively objective physical values, however, rests upon a questionable conception of comfortableness. Building physics investigates and codifies comfort via physically measurable minimum conditions, such as light intensity, atmospheric humidity, temperature, air exchange, and noise intensity. The > atmosphere, however, that is present in

instances of comfortableness, can hardly be generated via such physical or physiological conditions. The degree of illumination required for specific activities, for instance, as defined by building physics, may even interfere with the generation of comfortable conditions when elevated to an exclusive standard.

Of significance for comfortableness in a spatial situation alongside physiological well-being, in fact, are virtually all design features, especially the factors of appropriate room size, spatial proportion and gesture, orientation, the effects of materiality and colour, and lighting atmosphere. The transitions to concepts such as cosiness or sense of security are fluid.

Community

> accessibility and exclusivity, cosiness, dwelling, residence, warmth and cold

Complexity

Complexity is required as a complement to architectural > order and > simplicity. In both perception and aesthetics, it is a question of equilibrium between two poles. Too much complexity is too demanding, while too little can be unchallenging and tedious. The right amount of complexity is situation-dependent. In some instances, an enjoyable sensation of overwhelming stimulus is generated by complexity, for example when we find it delightful to get lost in a city, a childhood experience described by Walter Benjamin. If the objective is to achieve a state of meditative calm, on the other hand, a minimal level of complexity is desirable, although it might seem inappropriately monotonous in other situations.

Complexity begins with the variety and richness of spatial situations that are generated by architectural resources, for example through contrast of scale, form, colour, material, lighting and conditions of movement, and extends all the way to ambiguities, contrasts, and even contradiction. Perceptions of such phenomena are subject to particular significant condi-

tions. The complexity of an architectural layout, for example, depends significantly on > scale and angle of vision. A structure that may appear highly complex when seen up close may seem quite simple as a totality. If the elaboration of individual details is not consistently maintained, then conversely, the complexity of the total composition may be lost when it is approached. Up close, complexity must be visible in > detail. Concerning the relationship between contents and external appearance, Rudolf Arnheim wrote: ‘Complex structure can be housed but not expressed by simple shape.’ (1977/2009, 165) On the other hand, tension is generated when a plain exterior gives way to an interior that displays an unexpected spatial and formal elaborateness. Many examples of such contrasting polarities are discussed by Robert Venturi, who recommended ‘complexity and contradiction’ as architectural qualities: an > interior may coincide with the external space, > closure with openness, > body with space, duality with unity, and > centring with > directionality.

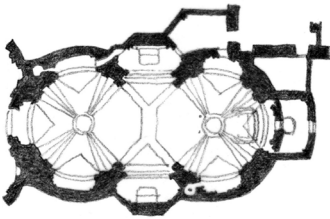

A special source of complexity in architecture lies in the diverse ways in which the design of the space is legible; a spatial complex is never perceived from a single viewpoint. Even a simple space may present us with a complex image if shifts of perspective yield contrasting perceptual results. This can occur, for example, when unexpected view axes present themselves suddenly at various locations, or when we discover that a location is integrated into a number of different overlapping spatial systems of reference (> transparency), which in turn appear differently depending on one’s location. Taking place within perception is a complex interplay that cannot be replaced by simulations. Individual perceptual components elicited from varying viewpoints are synthesized by short-term > memory to produce an imagined sense of the spatial totality. Every now and then, this complexity of possible perspectives of an architectural order must be brought under control, for example by an overview; otherwise, it will seem not complex, but instead merely complicated, and will produce an impres-

sion of bewilderment. Just as an inner richness can be discovered in simplicity, conversely, the multifariousness and contrastiveness of complex structures can be held together by the unity of a 'difficult whole' (Venturi 1966).

A spatial situation is experienced as complex not solely by virtue of its structural properties, but also when it permits or stimulates a multiplicity of options for action and movement. As a rule, then, the increasing penetration of the situation by an observer yields 'an infinite fullness of interpretations' (Friedrich Hölderlin), and leads gradually towards an enrichment and deepening of perception. The facets and variants of individual and collective appropriations of spaces are revealed by continuous > use to be growing steadily in complexity.

Finally, the contradiction of both/and, which seems at least initially to call into question the well-considered character of an architectural > concept, leads to stimulating multifacetedness and ambiguities. Deployed in an exorbitant or uncontrolled fashion, on the other hand, complexity leads to indeterminacy or a lack of > orientation, and hence to the sensation of being overwhelmed, or else arouses the impression of a mannered and arbitrary jumble. Employed in a purposeful way, it brings particular delight to puzzle out or see through the figurative variety, complications and obscurities of an architectural order that is nonetheless ultimately recognizable, and one that consequently fosters its expressivity.

Literature: Venturi 1966

Composition

In an architectural composition, the beholder experiences the comprehensibility of the form and the intentions of its author. Speaking to him or her through the commensurability and stringency of this formal composite, is a peculiar 'will to composition', which in qualitative terms goes beyond the outward appearance of the forms and their combination. In

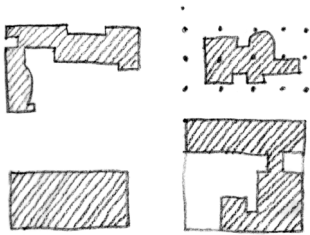

a composition, the parts are assembled into an articulated unity in such a way that a relationship of equilibrium is achieved between the self-sufficiency of the parts and the integrative force of the whole. The composition is a decisive aspect of architectural design on every scale, from that of the > spatial structure of the building, to that of a town and the surrounding landscape, but also that of the formation and interconnection of individual building parts and constructive elements, which are themselves in turn also composites. Composition is a means of avoiding arbitrariness, and not only renders recognizable the intention that gave rise to a structure, but endows with expression its painstaking crafting. For architecture, this intention is so essential that Le Corbusier – who used the term *architecturer* as a verb – nominated it as a core task. Composition not only assigns the parts of the building or the town to their correct locations, but also prepares the situation as a whole for users so that they are able to locate sought-after places and appropriate routes.

Renouncing compositional demands, however, are those groupings or clusters of constructive units that are primarily concerned with flexibility and standardization. In a megastructure that supplies a scaffold on the basis of a > row, grid or spatial lattice within which individual elements occupy flexible positions, as in the works of the Japanese group Metabolism, an almost arbitrary number of units can be added or subtracted without interfering with the total structure in any essential way. By contrast, a composition is based on a highly sensitive form of precarious equilibrium, one that is far from easy to achieve.

In a general sense, we understand the word *architecture* to refer to a well-planned construction, a > structure whose parts have been assembled into an ordered whole. An essential precondition is the recognizability of the way in which the composition has been articulated through the addition of individual structural and spatial elements (Latin: *articulus*, an individual member). Articulated through the type of compo-

sitional assembly and its relationship to an overarching form idea, in turn, is the architectural > concept. Bruno Reichlin and Martin Steinmann (1976) characterize the genuine formal and compositional structures of architecture as an ‘inner-architectural reality’. This reality is based on poetic procedures that are specific to architecture, such as the superposition of spatial orders (> transparency) and certain rhythmic articulations, which guide our attention – in ways comparable to the rhetorical figures of oratory – towards the intentional design of architectural configurations. Insight into the legitimacy and intrinsic value of the composition provides a kind of plaisir du texte, such as that prized by Roland Barthes in relation to literature. The predictability of the architectural > order provides the senses with the pleasure found in consistently fulfilled expectations, while the modalities of the situation (light, atmosphere) generate sufficient contingent variations. At the same time, the perceptual interest of a composition is often heightened when meaning and understanding are not immediately available, where recognition of the interconnectedness of all of the elements is delayed, and understanding achieved only through detours, processually.

Literature: Reichlin/Steinmann 1976; Wilkens 2000

Concavity and convexity

Concavity is an elementary resource for rendering the phenomenon of spatiality in architecture accessible to experience. The prestige of the form of the vase or vessel for containing architectural space is expressed eloquently in Rudolf Schwarz’s tribute: ‘A constitutive element of the art of building is architectural space, which is to say, that which is enclosed in the vessel of the walls and ceiling, floor and supports. A gentle, continually flowing shape made of light and life.’ (Hasler 2000, 28)

In the narrower sense, concavity is formed by a curvature, but the term may also be used in an extended sense to refer to angular forms and bent surfaces. The inner side of a

boundary that encloses a space is, seen as a whole, always concave, and its sparest form is an angle (> angle and corner). Accordingly, the concave side of a curve is regarded as an interior, and hence as a favoured > gestalt; the concave as an exterior. When facing a concave curvature, the beholder is equidistant from all points, is enclosed by it, and the gaze finds a terminus in a containing concavity. This relationship is observable in particular from a central position, but is also evident from other points and during circulation. A shape that is equidistant from us at all points is the easiest to grasp visually. Because the eye need make no depth adjustments, an impression of tranquillity and uniformity emerges. Corresponding to the concentric form of a concave curvature is the radial structure of the direction of the gaze in the form of radii that converge towards the beholder or emanate from him or her. A tunnel vault thus appears as a space that rises above us, and in which the radii extend centrifugally (Schmitz 1966, 47). In notions of the celestial canopy or heavenly vault, the sky above us also forms a concavity, one that is supported by the overhanging roofs of houses.

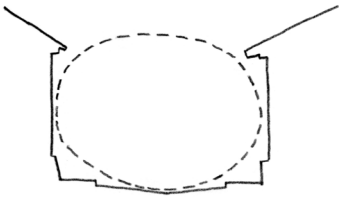

The formal expression and > form character of concavities is that of an enveloping and opening receptiveness. We feel ourselves contained by concave spaces. Concave walls, masses, or structural elements not only stand opposite us as counterparts, but also surround us, even when we turn and allow the gaze to wander. As the built concretization and formal correspondence to the > personal sphere, they make it possible for our bodily > extension to nestle into a containing form. Think, for example, of caves with rounded interiors. Gaston Bachelard (1964/1994) speaks of a 'round existence', and recalls the way in which birds press and rotate their bodies in order to shape the concavities of their nests.

While concavity represents the closing, enveloping principle, convexity represents the repelling principle of a bulging curvature that opposes us. The beholder is separated from a convex curvature at heterogeneous distances, and its percep-

tion requires multiple points of view. A convex form screens something from view, pushes forward, and causes movement to rebound. At the same time, it curves away from the beholder, drawing the > gaze into the distance by guiding it around the form or > body. The gaze may thus be guided again towards a concave form, one composed of adjacent architectural masses, such as the contours of a public square.

Basically, the relationship between concave spaces and convex bodies may be of two kinds: hollow spaces exist inside bodies or between them. In the first instance, a space is hollowed out of the body (Latin: *concauus*), and appears convex from the exterior. In the second instance, a number of (convex) bodies are combined to form a hollow space. One and the same convex body, then, may contain concave space within itself, and at the same time contribute through its exterior to the (concave) formation of a > public square.

As the 'Janus face' of the > space-body continuum, this interplay between concavity and convexity is fundamental for the shaping of architectural space, as characterized by Herman Sörgel: 'Spatiality in architecture consists not of an interior cavity and an external body, but of inner and exterior hollow space.' (1921/1998, 243) But as noted by Fritz Schumacher, the convexity of an architectural body participates in this interplay as well. Containment by a concave form may be interrupted at isolated sections by protruding convex figures, which invite us to circumambulate them or to enter their concave interiors. One circulates, for example, within the concave interior of a square, which itself is formed by the isolated architectural bodies that stand around it, by the fronts of buildings that stabilize movement from without. At the same time, every individual convex architectural body can be circumambulated, and provides stability as the centre point of this movement. However, where the architectural body forms the perimeter of a square, the two operations converge, so that concave and convex effects are superimposed. Once a building has been entered, and assuming the interior

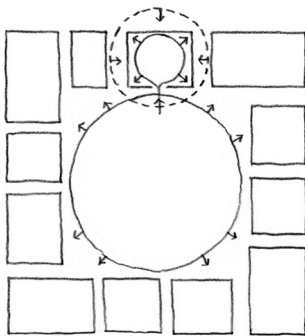

is fairly sizable, the concavity of the walls once again frames a circulating movement. Concave and convex forms, finally, may also alternate in a rhythmic, sequential arrangement of recessive and protruding forms that effect transitions between repulsion and pull.

Literature: Bachelard 1964/1994; Schumacher 1926; Sörgel 1921/1998, 1925

Concealment

> cellar, depth, filter, porosity, screening, space-containing wall, transparency

Concept, architectural

The architectural concept is the idea that guides spatial creation and according to which a design is elaborated, and at the same time it offers the key to adequately comprehending the work as ultimately realized. The word's provenance, the Latin word *concipere*, implies both meanings. The concept must also take into account the fact that the result will be experienced not as an object, but as a situation. A series of further terms, which are often treated as though they were indistinguishable, including *design principle, architectural > theme, basic idea, guiding principle and conception*, are also concerned with the conceptual structure of a spatial design that is to be accessible to experience through its realization in built form.

The architectural concept goes beyond the fulfilment of technical requirements and functional needs by also investing in something that Theodor W. Adorno referred to as 'architectural fantasy', and is at the same time oriented towards a building task by the postulate 'that something can occur to the artist out of space itself; this cannot be something arbitrary in space and indifferent towards space.' (1979, 37–38) Every conception is also an interpretation of a building task, so that an understanding of the concept and its interpretive intentions is hardly irrelevant to an understanding of its reali-

zation. A contribution to understanding is made, for example, when > spatial structure appears in the form of a lucid configuration, when the concept reflects the character of the > place, works with comprehensible analogies, follows a manifest > gesture, when the conceptual layout represents a recognizable > type as a ‘typological decision’ (Rossi 1977), or when the structural totality is graspable as a well-considered > composition. The clarity and coherence of the concept are also made perceptually evident through formal geometric operations, to the extent that these satisfy the central demands of the building task.

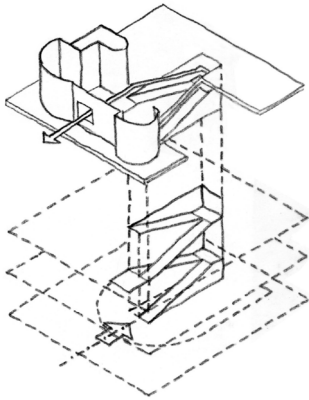

The > readability or comprehensibility of the architectural conception presupposes the transparency of its > structure, which may be recognizable in places such as an access figure, for example a staircase. In particular, the plan directs the discursive logic of the spatial structure by leading through the rooms and by dividing, articulating and alluding to the operations to take place there. At every additional phase of elaboration, the idea becomes readable in a different way, so that ideally, even design decisions in > detail are borne out by the total concept and reflect these. The more differentiatedly the context of justification is elaborated at the level of detail and execution, the more multifaceted are the experiences of residents or users as they mentally reconstruct the situation as a work that has been prepared, thought through, and intended for them. Through use, they participate in the creative act of space creation, and ‘learn to be astonished at its conditions’ (Reichlin/Steinmann).

Literature: Boudon 1991; Reichlin/Steinmann 1976

Concinnitas

> beauty, order

Confrontation

Walls and facades not only delimit spaces and public squares, but also at times literally present their faces to us. When it

stands directly before our > gaze, or in our path, a building seems to confront our own bodies with its mass. Its front offers resistance, calling upon us initially to maintain a certain distance, while giving the measure of its spatial sphere of influence (> space shadow).

In Latin, the words *frons* and *facies* mean 'face'. When looking at what is vis-à-vis, one is also looked upon, albeit only when standing face to face, not when merely passing. The front of the building, however, may also shift to face us as we move (> movement) along a street, i.e. when a street is skewed or contains a bend, so that often enough, moreover, the facade is shifted out of alignment with the street. The intensity of such a confrontation is dependent upon the position of our vis-à-vis. An explicitly frontal position blocks forward movement; a gently oblique positioning only slows us down, leading further and dissolving the confrontation. Things are similar with the diagonal positioning of a wedge form that bifurcates our path. A dramaturgical conclusion is formed by confrontation with a visual goal, which is required by a trajectory of movement as a special terminus if continuation into emptiness is to be avoided.

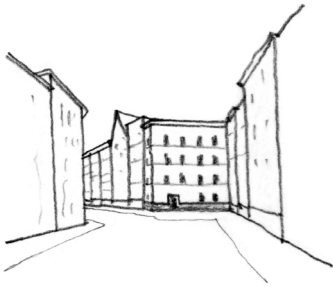

Its > form character, > details and > coloration determine whether a front approaches or retreats, whether it offers resistance or seeks closer contact. Either it allows the gaze, and hence movement, to rebound, or else it encourages approach, providing our > extension with a goal; as a counterpart, it welcomes us and invites dialogue, or shuts itself off, refusing us.

Buildings or three-dimensional objects also confront one another through their positions, whether this takes the form of a harmonious vis-à-vis between > facades or > bodies, or instead of confrontation or conflict between architectural structures. As long as we move about between them with our own bodies, we find ourselves occupying the texture of tension between the sculptural bodies that are distributed within space, and are exposed to the > force field that spans itself

out between their masses and fronts. It can also be the case that the buildings do not turn towards us, but towards one another, for example on the Acropolis, where, as Rudolf Arnheim has observed, the visitor is 'meant to understand that the temples are there for one another, and not for him.' (1998, 27)

Connection

> door and gate, form character, ingress and exit, inside and outside, intermediate space, joint, opening, threshold, view into/out of

Constriction

> expansiveness and constriction, movement

Construction

> architecture, detail, structure, tectonics

Context

Architecture is always a part of a context, while itself forming a context. It is dependent on context, but at the same time transforms and interprets it. While architecture follows general principles of architectural > order or of an architectural type, it is also subject through context to the special features of the topos and the conditions of a > place.

The spatial context of the individual building, into which it is woven (*contextus*), forms to begin with the environs of the town, with its buildings, streets and public squares, and the surrounding > landscape with its topography and vegetation. In an extended sense, the concept of context extends to social, cultural, economic, legal and historical relations, and may be pursued in broader, and to some extent no longer clearly identifiable, spheres of dependency and influence. Conversely, going into detail, an individual room or architectural element may be considered in the surrounding context of a building. Accordingly, every object, and every room is perceived in a context, one that is in turn embedded in a wider milieu. In this way, by shifting to successively larger scales, we pass from one context to the next.

The spatial context of the building, however, is no arbitrary superimposition of heterogeneous environmental con-

ditions to which one is free to refer selectively. In the city, the surrounding space itself has a specific > structure, with its orientations, dimensions, striking points, and distinctive > atmosphere, which contributes to shaping our perceptions of every individual spatial situation. A targeted reference to the context that might be characterized as contextualism should not be restricted to achieving integration into the architectural substance of the immediate vicinity through the harmonization of formal idiom, scale or materiality, or through complementary contrast. On a larger scale, context rather means the network of interrelationships between the points of reference and public spaces and buildings taken into consideration by urban planning, which also reflect the historic context.

Emerging, however, through the interplay of architectural masses with interior and exterior cavities on a smaller scale is that conceptual weaving together to which Fritz Schumacher has referred as ‘the art of designing spaces through the designing of bodies in dual ways.’. (1926, 28) This > space-body continuum either consists of the intimate interpenetration between architectural bodies and the surrounding space, or else loosens them up so that it ultimately unravels, and the building appears isolated. Because this ambivalent figure/ground relationship within the urban texture cannot be distinguished in principle from that between the mass and cavity elements within a building, a town may be regarded from a contextual point of view like a building, and a building like a town. Accordingly, Aldo van Eyck perceives neither sharp divisions nor flowing transition between mass and space, inside and outside, open and closed, but instead a relationship of reciprocity, in which each is generated by its counterpart. Sometimes, buildings refer through individual elements such as > facade, > tower or > axis to various adjacencies, or even establish more distant relationships. Public buildings are interrelated with their contexts when their uses open them up to their surroundings, making them traversable – primarily at ground level.

The spatial context of the landscape is interwoven with the building, i.e. when both belong to the same order, or are interlocked with one another as complementary figures, for example when the outer containing walls are configured in such a way that they frame the exterior space. But as a context, the landscape complements a building primarily by extending the space in relation to its interior, opening up expanded vistas, while delimiting this broader space.

Every reference to context presupposes a specific interpretation; based on it is either the differentiated confrontation with the context, or its deliberate neglect, i.e. where the focus of attention is entirely on a free-standing and sculptural architectural form. The demonstrative non-response to context on the part of megastructures has been characterized by Rem Koolhaas with the words: ‘Bigness is no longer part of any urban tissue. (...) Its subtext is fuck context.’ (Koolhaas/Mau 1995, 502) Yet such an attitude itself represents a communicative response to context, one that in turn itself generates context. *Literature: Van Eyck 1960/2003; Kemp 2009; Rowe/Koetter 1978; Schumacher 1926*

- Continuous space > flowing space, space, space-body continuum
- Convexity > body (architectural), concavity and convexity, form character
- Corner > angle and corner
- Corridor > access, courtyard, gallery, route
- Cosiness > comfortableness, dwelling, warmth and cold, residence

Courtyard An interior courtyard is the space within a building that is set beneath the open sky. There, one is outdoors, and can engage in certain activities out in the open without actually leaving the house. In the form of a kind of spatial > inversion, the courtyard can be conceived as an exterior space that is everted so that it occupies a building’s interior. In his

buildings, Tadao Ando restricts contact with nature to the experience of air, cold, rain, snow, and certain sounds (the voices of birds, the rushing of the wind) as the essence of outdoor-ness, thereby opening up the interior to the outside as a courtyard. On the one hand, the courtyard is of course an outdoor space; but a series of characteristics makes it an interior one as well: an inner courtyard set at the middle of a house occupies a central position between the inner rooms, and is nonetheless sheltered against prying eyes, wind and the noise of the surrounding town. Suitable proportions in cross-section endow it with > closure, its regular form singles it out as a distinct spatial figure, and painstaking design makes it a suitable place for the household community to gather (> gathering) together under open skies.

Related to the courtyard is the forecourt, which is essentially an > intermediate space that forms a transition to a public urban space. Related forms are the access yard, often built into the > corner of a building, and the barracks yard, whose dimensions makes it a borderline case in this context. As a *hortus conclusus*, the garden courtyard combines traits of courtyard and > garden, for example in the cloister. Common to all of these forms is a degree of closure, and all convey – despite their openness – a delimited interior zone. The public > square, by contrast, is distinguished from the courtyard by virtue of its location and its explicit status as a public space.

Yet existing between building and courtyard in a way similar to that between architectural volumes and public squares is a figure/ground relationship involving architectural body and empty > space. On the one hand, interior and external spaces intersecting in the > space-body continuum. On the other, the courtyard forms a link in the chain of exterior spaces, whether in a > sequence of courtyards, such as the Hackesche Höfe in Berlin, or through the > incorporation of interlocking courtyards of various sizes, for example in the forbidden city in Beijing, where one has the peculiar experience of exiting one courtyard only to find oneself inside the next.

Many buildings require courtyards for illumination. Windows and doors that look out onto courtyards, which may even be only diminutive air wells with glazed roofs that hardly qualify as exterior spaces, give the impression of opening towards the outside. Here, the outside world does not seem shut out, as it does when illumination is purely via skylight. The rear courtyards of apartment buildings, however, are often reduced to the status of light shafts, which moreover may interfere with coexistence by transmitting noise between units.

Building and courtyard enter into a time-tested connection in the courtyard house, with the patio or atrium house found among the most incisive architectural > types. In an evident correspondence between form and lifestyle, the spaces of courtyard and house form a cohesive structure. Examples are the Roman atrium house and the traditional courtyard house (hutong) in Beijing. In the courtyard complexes of multi-storey buildings, for example the ‘Wiener Wohnhöfe’ (i.e. the spacious courtyards of Viennese apartment buildings), the courtyard is a semi-public space and is intended for the community.

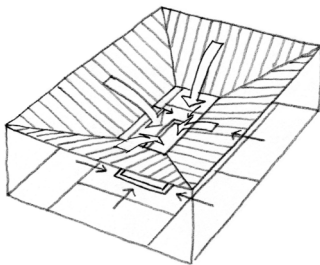

The *compluvium*, the rectangular opening in roofs of Roman residences, through which rainwater flows in from all sides to enter a basin (*impluvium*), is interpretable as an animated emblem of a centripetal or introverted > figure of movement: as a space of > access, the courtyard is simultaneously a centre where occupants, entering from the ring of surrounding rooms, engage in activities that require light, air and room for movement, and a setting for receiving guests. Conversely, this > spatial structure can also be conceived as centrifugal, since movement flows from the community space of the courtyard with diminishing degrees of > accessibility into individual zones. In courtyard houses where a passageway runs around the perimeter, separating open space and surrounding rooms, especially as an arcade (peristyle courtyard), concentric > circulation is added as a characteristic

movement. As a permeable interior > facade, this ring of columns expresses the house's introverted character, while the street facades of Roman houses, for example, generally receive no articulation. By virtue of its tripartite stratification, consisting of colonnade (> arcade), ring of rooms, and outer wall, the peristyle courtyard is emphatically screened towards the outside. Particularly noticeable in contrast to the variability of the facades that customarily enclose an urban square is the homogeneity of the spatial delimitations of interior courtyards, especially when formed by continuous rows of columns or other types of highly uniform facades. Those spending time here may have the impression of being confronted by four uniform sides, and even the sensation of being looked at – that at any moment, a figure may emerge from between two columns. Here, the oscillating movement (> oscillation) typical for centralized spaces extends from the centre all the way into the surrounding arcade; an example is the circular courtyard of the Palace of Charles V in Granada. Inner courtyards with elongated basic forms, on the other hand, seem to prescribe directed movement, either towards a principal building, or as a passageway, or in a back-and-forth motion.

Covering

Architecture can be defined as the shaping of space by means of covering a structural framework. The decisive role is played by the spatial covering, which provides protection and at the same time assumes expressive and decorative functions in ways analogous to human clothing, while the construction is responsible for framework and support functions. This phenomenon becomes an architectural > theme to the extent that it is visualized in the design, for example through repeated and multilayered covering, or by the articulation of the difference between covering and covered.

According to Gottfried Semper, architecture is essentially the art of covering. Accordingly, its primary task is the creation of a spatial shell; not the constructive court core, but

the outer cover is the essential element of architecture. In fact, it is primarily the > surface of the walls that we perceive in a work of architecture. The > wall (*Wand* in German, a word that is related etymologically to the word *Gewand*, or garment, a relationship suggestive of the wall's covering function), can be regarded as a planar element, which, filled (in) or suspended like a curtain, and freed of any load-bearing function, serves a primarily refining and communicative function alongside a delimiting one. A solid masonry wall is also endowed with the character of a cladding element when it is given a covering, if only a simple layer of paint.

For appeals and the creation of mood, the effect of surfaces is decisive. In close proximity, the linings of rooms and the coverings of > facades also offer the sense of touch the option of discovering and exploring details, just as the eye is offered visual stimuli in an overview from a greater distance. Through their > materiality, colour and > ornamentation, always beginning from the surface, diverse approaches to covering create > atmospheric and scenographic effects – from purist elegance and primness all the way to sumptuous opulence.

Our bodies are protected by our skins, while additional protection is provided by clothing. The architectural shell is a third skin of sorts. The sheltering of the body through architectural containment is further intensified as a form of design expression when the building is clad with additional layers. Just as we underscore the significance of the protection that clothing offers our bodies by covering them in multiple layers as desired, we express our ideas about screened-off living spaces especially clearly when we surround ourselves with an architectural covering consisting of multiple layers (> incorporation).

The structure, which makes its appearance through the form covering becomes remarkable either through the quality of the covering, i.e. by being encased in a precious, shimmering garment, from which the body itself emerges mysteriously only at a few places. Or there is a tension between the form

of the covering and the invisible core, a concealed form that can be intuited only from the cladding. The covering need not necessarily adhere to the body, recapitulating it, but may also depart from the shape of the body by being loose and independent, by means of > folds, for example. As with garments worn by people, the architectural covering plays more or less closely around the constructive shape that lies underneath. But this play also involves the possibility of > intermediate spaces or empty layers, which may be deployed consciously as buffers or as spaces of > resonance or clearance. This offers many possibilities for indirect perceptions of > depth as mediated by surfaces, which may range from total camouflage all the way to faithful recapitulation of the underlying form. Here, it is not primarily a question of veracity versus inauthentic masquerade, but of the subtle possibilities for the spatial development of the play of exposure and concealment as a primordial human theme. The potential for identifying traits or self-display offered by cladding, however, also allows one to signal, via architectural coverings, who or what one is. *Literature: Loos 2002a; Semper (1860–1863/2004)*

Cupola

> ceiling, roof

Dance

> field, figure of movement, rhythm (spatial), roaming, stairs

Darkness

Dark rooms address our receptivity to atmosphere in very special ways. It is not a question, however, of sharp contrasts between darkness and > light, but instead of generating differentiated perceptual possibilities that become possible only through a marked decrease in background brightness. Only seldom are architectural spaces deliberately submerged in total darkness, since their accessibility to visual perception is then virtually eliminated.

Indoor darkness need not necessarily signify deficient illumination, but may instead create its own experiential quality. Already in twilight, rooms often acquire a mysterious, crepuscular, floating character that can seem either disquieting or containing. The darker a room is, the more strongly it opens itself up to other levels of > sensory perception, for example, hearing, the sense of smell, or haptic sensitivity. When spatial boundaries become diffuse and dissolve in the darkness, our own location in space becomes indistinct. On the other hand, our perceptions of our own bodies within space are heightened in very dark rooms. In darkness, we experience the expansion of our > personal space yet feel ourselves centred more strongly within our bodies.

An extremely dark room has its own density and indefinable > depth, which does not correspond to its actual extension when fully lit. In normal lighting, space – the emptiness between objects – is not perceptible in itself. In the absence of light, on the other hand, the space seems to be filled with darkness. We have the feeling that it touches and wraps or enshrouds us, and at times feel infused by it. In darkness, the distinction between inside and outside is attenuated.

The density and impenetrability of darkness causes us to move more slowly and tentatively in an unlit room. We find it difficult to anticipate the intervals between objects; depending upon the acclimatization of vision, they emerge from the darkness gradually. As a consequence, glimpses of individual weakly illuminated objects or small, light openings are enhanced in importance. Things remain embedded in darkness; at times only indistinctly recognizable or even enigmatic, they draw us towards them. The meagre light cast on their surfaces seems somehow precious. Such effects are exploited in particular in the interiors of churches and cult spaces in order to produce atmospheres of holiness.

In extreme cases, the deep blackness of large darkened rooms is capable of generating a pull that threatens to swal-

low us up, but may also, provided they are experienced with aesthetic distance, convey feelings of > sublimity.

Within Western culture, acutely differentiated perceptions of such phenomena are reflected in paintings of Dutch interiors dating from the sixteenth to the eighteenth centuries. In painting in general, chiaroscuro effects are in many instances not attributable to polar contrasts between light and dark, but instead to a fundamentally dark atmosphere that exploits highly differentiated light/dark values.

The meaning of darkness and of highly differentiated distribution of brightness is emphasized strongly by Jun'ichirō Tanizaki with reference to traditional Japanese architecture. In Japanese culture, darkness and blackness are phenomena that – differently than in the West – are cultivated with subtlety and invested with a rich range of meanings. There, clarity is not aimed for by means of brilliancy; instead, the differentiated play of shadow and half-light, of matt and gently shimmering dark materials allows an intuition of the genuine qualities of things. Darkness is generated in Japanese interiors by means of overhanging, low roofs and deep rooms. The light, variously filtered, that falls through paper windows (shoji) seems to have been atomized into tiny particles and dispersed uniformly throughout the space. Such factors confront users of interiors with very soft and finely differentiated transitions of illumination. Only through reduced or minimal illumination does the subtle grading of brightness become a finely tuned instrument that allows the articulation of space even in the absence of divisions by screening elements. On the other hand, darkness seems strongly to contain and unify the atmosphere of the situation as a whole. Against a dark ground, > materials, > surfaces and > colours acquire a singular and highly differentiated spectrum of effects. Reflective highlights consisting of gold, luminous colours, and brilliantly lacquered surfaces provide conspicuous accents within the framework of a dark basic atmosphere.

Literature: Janson 2003; Tanizaki 1933/1977

Daylight
Decor

> atmosphere, light
> atmosphere, covering, ornamentation, wall

Density, spatial

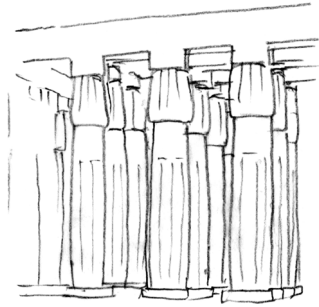

A room with an especially high density appears impenetrable to the gaze, and inhibits forward movement: one tends to freeze up. Such an impression of density is generated when room-high elements or those set at eye level, supports, pillars, wall panels, or solid bodies are configured within a spatial volume in large numbers and with minimal distances between them in such a way that although it is possible to move between them, there is little space for the > gaze to make its way around them. The room, then, extends beyond the point the gaze can reach; its boundaries are not available to sight. It is impossible to determine whether the room has walls at all, whether it is open to the outside or is contained. Vision is limited by obstacles, but is able to find its way around them nonetheless, albeit without being able to extend much beyond them. A telling characterization of such an experience of extreme density – for example in the hypostyle hall of Amenophis III at Luxor – is provided by Otto Friedrich Bollnow, who compares it to that of a person walking through a dense forest: ‘As soon as he penetrates into it from one side, he is unable to evade the captivity of the gaze, and cannot look out into an open area; instead, a constricted zone of visibility moves along with him like a shadow: he cannot escape this narrowness, remains enclosed within it.’ (1963, 218). A uniformly dense distribution of columns interferes with > orientation, since no particular directionality enjoys priority.

But density is not the only result of the presence in a room of constructive elements at minimal intervals; a sense of ‘pressure’ between them, which takes shape in the imagination, may also result from their mass and form (Arnheim 1977/2009). Density in an architectural complex results from a high proportion of mass in relation to empty volume, for example in fortifications having small rooms and thick walls

that are penetrated only by niches and slits. The solidity of heavy, impenetrable solid masses can endow spaces with a constricted feeling. Certainly, spatial density can also be achieved through the arrangement of thin supports or wall panels. Density is minimal where a space expands (> expansiveness and constriction) outward without interruption or articulation. Density increases when the space is filled with elements; at the same time, its segmentation into > depth becomes palpable to the senses. Density may be heightened further through the close placement and staggered arrangement of elements.

According to Jürgen Joedicke (1985), density is a feature of architectural space that occupies a position between the extremes of emptiness and solidity. He refers to a space that is endowed only with an external (peripheral) density of spatial limitations as a 'container'; one that is entirely densified within, on the other hand, is a 'body'; while a spatial field set only between corner demarcations is said to possess neither outer nor inner density. Depending on the type of structural density, our > personal space has a tendency in extension to thrust its way, so to speak, between obstacles. Spaces of high density convey an impression of solidity and stability. Within them, one feels almost embedded in a mesh; in extreme cases, one feels immobilized. In unfavourable instances, such effects can even engender feelings of oppressiveness or loss of orientation. By contrast, rooms with minimal density seem clear and straightforward. When they become too large and bare, one may feel lost in them; on the other hand, they present no obstacles to expanding movement, and by virtue of their unarticulated unity, are characterized by decisiveness.

Clearly going beyond spatial density in significance, however, is that which one might term experiential density; here an aesthetic densification on various sensory levels is associated with a wealth of additional emotional, bodily and intellectual connections. In the context of urban planning, density is decisive for the experience of urbanity in the sense of being eventful, one that is achieved less through structural

density than through the convergence of multifarious social and cultural worlds.

Depth

A sense of tension that reaches into the depths of a space is generated via spatial perception. Gaze and movement extend into depth in order to overcome the distance from objects and spatial delimitations, and to take hold of space, traversing it in the imagination (> extension).

In the context of architectural perception and movement in space, it is the third dimension, i.e. depth, that is decisive, because it coincides with the accustomed directionality of the gaze and of movement. Levels (> level) that are expanded in height and breadth offer the > gaze a planar goal and > movement a boundary, but only in the direction of depth do gaze and forward movement penetrate into space. August Schmarzow characterized movement into depth as the principal mode of movement for an adequate perception of architecture.

Spatial depth becomes graspable through forms in space. Strata of buildings and architectural elements that are staggered, one behind the next, and which partially obscure one another, lead through partial visibility into the depths. In the process, our spatial imagination can to a certain extent find its way around obstacles and penetrate the zone of the room that lies behind. While depth perception is supported when architectural forms are recognizable as solid, three-dimensional elements, it tends towards abstract planarity when they appear only as staggered planar levels. The architectural clarification of spatial depth is served, for example, by the articulation into more proximate constructive or spatial elements, all of which are visually graspable, and more remote and progressively distant ones. Depth is also achieved by means of successively distant framing devices (> enfilade), views, and view axes. The formal dynamics of staircases in particular lead the gaze into the depths. Moreover, effects of depth can be attained through the interplay of light and shadow, for instance

through the twilight atmosphere of the > spaces of resonance of chambers, or beneath ceilings and vaults, or through the attraction exercised by a light-filled opening – which may also seem to guide us in space – within the dark depths of a room. Perception of a variegated spatial articulation in depth requires a continuous accommodation of the eye, a sensory activity that corresponds to mental activity. ‘The notion of the depth of thoughts is derived from physical depth.’ (Arnheim 1972, 232)

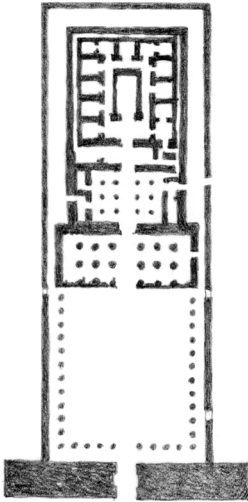

Spatial layers that are staggered into depth may be inserted between > inside and outside by means of > intermediate spaces such as loggias, verandas and > arcades, thereby effecting a graded transition. Produced for the sake of movement is the experience of the depth of a spatial structure through the > layering and staggering in succession of rooms that must be traversed in order to reach a goal. The act of traversing a > sequence of preliminary stages heightens the drama of approach and the significance of the goal that is ultimately attained. Examples are found in Egyptian temple architecture, with its entrance halls and multiple passageways, whose centre is the inner sanctum. Present here, however, is an axial directionality into depth.

The staggering of elements into depth and the use of axes leading into depth and of receding sequences of rooms are devices for articulating the structure of buildings and cities in depth; they guide us towards destinations and centres, prescribing > routes towards goals. But there are also experiences of spatial depth that involve penetrating into a nebulous depth hesitantly by feeling one’s way forward. Here, directionality is not prescribed by an axis, nor by the coherent staggering of elements. Now, we do not transgress explicit boundaries in order to traverse a building or a city in depth, layers are not penetrated in order to arrive at a centre or an interior space. Prevailing instead is a ‘soft’, flowing transition between inside and outside. The configuration of depth in the form of the folding (> fold) or convolutions of overlapping layers remains

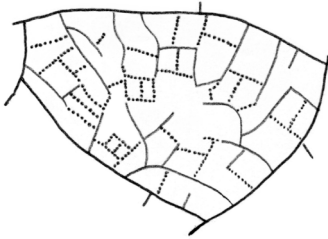

indefinite, leads to no clear centre. Such folded structures flow instead into indeterminate depths, while nonetheless offering a tremendous enrichment of spatial depth, even in relatively confined spaces. With reference to the traditional Japanese house or the layout of the historic section of Tokyo, Fumihiko Maki characterizes this phenomenon with the principle of *oku*. Here, in contrast to the decisiveness with which the relationship between centre and boundary is shaped in European culture, the attainment of the goal does not represent a climax; drama and ritual are instead embodied in the process of approach itself. Movement is not the goal-directed tracing out of a route, but instead searching, > roaming. Through the prolonged, impeded, and indefinite approach into a virtually unattainable distance, the goal acquires the significance of spiritual depth or of a secret and concealed space.

Literature: Gosztonyi 1976; Maki 1979

Design / Design process

> concept (architectural), theme (architectural)

Detail

Nowhere in architecture is the central problem of the assembly of various parts and the expression of their respective roles for the whole present more clearly than in the detail. An integral detailing is a particularly visible expression of logic and consistency in architecture. It allows the totality to be reflected in the smallest elements, and allows overarching constructive relationships to be intelligible and perceptible on the > scale of detail.

In architecture, a detail is not simply any arbitrary, individual feature, but more specifically the separate shaping of those places where constructive elements are finished off or joined together with others so as to articulate the total structure. This includes, for example, frames, > thresholds, mouldings, > bases, and connections between materials. Places that are touched by users receive special detailing.

Detailing may follow various strategies; points of convergence may be accented, underplayed, concealed, or in the case of shadow gap, left in darkness. As a consequence, the shaping of details does not just serve construction, but also endows the assembly of parts with meaningful expression. Its explanatory potential extends from gradual and even seamless transitions, to dissociations, and all the way to effects of conflict and repulsion; it can call attention to the interrelationship of parts by interlocking or interpenetrating, or through their enclosure. The artistic interpretation of the joint becomes an expression of concern for users as a manifestation of the proverbial love of detail.

Because the detail determines material contrasts between interior and exterior, and between floors, walls and ceilings, spatial structures and forms respectively are interpreted in various ways. Often, it is only the details that render architecture readable. The base of the building clarifies its contact with the ground simultaneously as attachment to and reconciliation with it. A gap between a ceiling and a rising wall, for example, can contribute to a room's appearing less as closed-off container and more a space above which the ceiling 'floats'. Window frames set flush with the wall, and hence invisible inside and without cast shadows, allow windows to disappear so that the room seems to flow without impediments. The base, capital and shaping of the shaft of a > column render the bearing of weight in connection with the ground below and the member above comprehensible in ways that crude steel supports or unshaped timber beams cannot.

The detail as a special individual form solicits the intensive experience of physical touch (> haptic) and close viewing, especially when it is a question of those detailed forms that are used via direct physical contact, including banisters, handrails, > windows > and doors, or levers and switches. Especially important for physical manipulation is a design's intelligibility. Such elements, easily understandable as simple objects, become less so when developed into complicated ap-

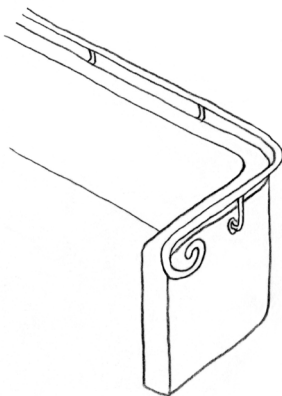

paratus. Opposing the possibility of allowing a detail to serve various functions is a strategy that separates its various tasks from one another, thereby clarifying them. A handrail, for example, may be set off from a concrete balustrade in order to distinguish clearly the functions of guarding against falls and providing a handhold.

A special function is served by details that act as symbols to convey meaning, as decorum. They ensure that the significance (> meaning) of a building's owner, function or social role is accurately visible, mirror its symbolic content, or serve as > ornaments (> ornamentation). An artistically coherent system of details can also be regarded as a kind of language; a building's character is displayed in a specific selection of details that correspond to the painstaking and effective selection of words in literature. Through details, some architects have given evidence of exceptional inspiration or special idiosyncrasies. There is, for example, the famous 'Mies corner', which displays – in addition to a number of further specific details – the architect's handwriting; reused elsewhere, they have the effect of a personal signature.

Literature: Kemp 2009; Weston 2003

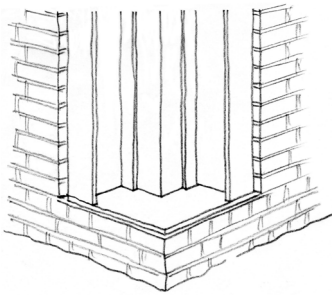

Dignity

> column, patina, postures, monument, ritual

Direction

> directionality, gaze, ingress and exit, movement, plane, route, stairs, wall

Directionality

Because spatial direction in architecture is perceived in different ways, a cubic room features no uniform relationship between its sides. Since we are connected to the ground by the force of gravity, and hold ourselves erect, the vertical axis is of decisive importance for our footing. The longitudinal and transverse directions, however, compete under the influence of apertures, wall divisions, and lighting. We are constantly exposed to directional impulses.

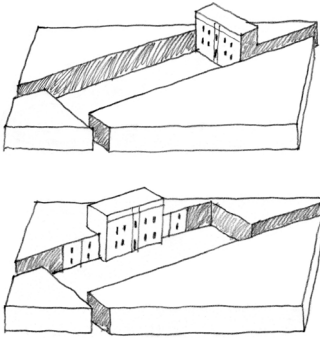

More evident than the directionality of cubic spaces is that of oblong spatial forms, which appear a priori longitudinally oriented. On an urban plaza, however, the dominant building facade organizes spatial orientation around itself and its position on the > square. When the building stands on the narrow side, the square seems to be oriented in depth, and when it stands on the long side, in breadth. Camillo Sitte therefore referred to deep and broad squares (1889/1983). Spaces on every scale, then, may display directionality provided they are oriented towards a dominant element, or towards a particular side or direction.

In a landscape as well, spaces appear to be oriented, i.e. towards the forest, sea or mountains; it may stretch out towards a town or natural landscape, or up or downstream. Directionality is an expressive quality that is evoked in individual buildings in particular through the > form character of facades or roofs, the gable- or eave-fronted position, and through the form or positioning of openings, which appear turned towards us or averted, opened or centred. Through gestural quality (> gesture), a spatial situation acquires its characteristic dynamism. We are familiar with the vertical tendency of growth and ramification that orients Gothic buildings and spaces in height, while oval, trapezoidal or triangular plans, for example, ensure that a space is oriented horizontally.

But we do not attribute directionality to architectural forms solely by virtue of constructive features; we also experience directionality based on the disposition of our own > bodies. Our corporeal configuration is unidirectional in relation to the space that lies before us. To take something in visually, to direct the > gaze onto it through a pair of eyes that are directed forward, thereby proceeding in a focused way, is a fundamental mode of human experience. The motor function of our legs is also primarily oriented forward. This basic constitution compels us to seek out a destination point that lies before us and opens up a potential frontal zone as a possible direction of movement. Perception is particularly attentive to that

which lies above, probably because the ascending direction corresponds to organic growth and overcomes > heaviness.

Architecture is responsive to our sense of directionality in various ways. A significant resource for establishing directionality is guidance by means of a series of identical elements, i.e. in a colonnade. The effectiveness of such steering is enhanced the more a space seems to derive its orientation from its proportions. The corridor character of an elongated space can be generated by flanking walls as in an urban street, but also, for example, via a repetitive > sequence of elements, i.e. the dramatic heightening caused when they seem to draw together progressively in the distance. They 'lead us further, permit no wavering', as Georg Simmel (1998) expressed it. Playing an important role in the directional gesture of such arrangements as well is the perspectival convergence of walls or rows of pillars on both sides. Through the guiding function of the walls, the directionality of a space may be repeatedly altered, whether gradually or suddenly. An extreme instance of such directional variety is the labyrinth.



Another medium of directionality is the setting of striking termini, i.e. by means of gates or > towers under the application of the > axis principle or by accenting the middle in order to centre a space or public square. Because, as phototropic life forms, we turn towards the > light, lighting design has a directional impact on interior spaces. In dark rooms, we strive towards the light of windows or towards illuminated objects or lighter zones, and derive directional orientation upwards from the zenithal light above. Through the multifarious possibilities of brightness distribution, light is a particularly effective medium of directionality.

Distance

> complexity, expansiveness and constriction, facade, gaze, scale, sequence, size, tower

Division

> door and gate, ingress and exit, inside and outside, intermediate space, opening, screening, views into/out of, threshold, wall

Door and gate

By virtue of the fact that a door can be opened, it can also effect closure; only because it can be closed does it function as an opening. It is therefore the constructive element through whose mobility the reciprocal conditioning of closure and opening, division and connection, find explicit expression as fundamental architectural functions (> screening). A door marks off and regulates the boundary between inside and outside, and between separate rooms. In the words of Georg Simmel, the door is the connecting and dividing 'pivot' that goes beyond the contrast between inside and outside, even surpassing the expressiveness of a mere dividing wall: 'Precisely because it can be opened, it provides, when closed, a stronger sense of self-containment in relation to everything outside of the room in comparison to a mere undivided wall. The latter is mute, while a door speaks.' (1998, 172) In many verbal formulae, this 'speaking' door stands for the building as a whole, for example when people live 'right next door', or when the door stands metaphorically for certain kinds of access, as when 'cordiality (or money) can open any door'. Many architectural phenomena such as > opening, > ingress and exit, the > threshold, and the > filter, are objectified by means of the door as a structural element. Door niches, embrasures, porches and porticos are spatial extensions that expand the initially flat object into an > intermediate space, or even to the scale of a gatehouse of a palace or town gate. Alongside the fundamental significance of the door for entrance and exit (1), the operation it requires (2), and its relationship to adjacent spaces (3) merit special attention.

1. Whether we enter or leave a house through the door, or pass from the living room into the kitchen or from an office corridor or hotel lobby into a room, or open the garden gate, we act each time in a different situation, and the respective door plays a different role. Our experiences of doors are just as variegated as the situations in which they play a part, and as multiform as the forms, details and architectural configurations of threshold spaces in general.

A particularly complex situation is opened up by the door of a private house or an apartment by virtue of the manifold modulations of invitation or defence, of orientation, communication and control. Before a stranger's door, the individual – who stands either outside or in a kind of transition space, on a doormat, entrance grating, beneath a porch or in a protective door niche – signals his or her desire to enter by knocking or ringing a bell. The visitor is then perhaps observed or interviewed, through a crack in the door, window, a spy hole, or an intercom system, before the door is opened hesitantly and distrustfully, or flung open joyfully. By taking hold of a knob or latch (the house's hand, so to speak) the entrant has his or her first tactile contact with the house. A door handle may be large or small, may move smoothly or stiffly, may lie in the hand smoothly or have sharp edges, may be polished or rusty, perhaps reflecting the house's character outwardly. Equally eloquent is the character of the entry door, its materiality, thickness or transparency, and the direction of its opening, whether towards the visitor or into the house. Then there is the resistance it offers, the sluggishness with which it opens, thereby according the act of entrance a certain weightiness, and finally the noises, the tell-tale creaking in contrast to the soundlessness that allows arrivals and departures to take place without notice, or perhaps the rich sound with which a heavy door swings shut, conveying solidity and security.



Directly after the door is opened, the entrant experiences all of this as bodily graspable, immediate expressive qualities, in contrast to the image or symbolic character exploited by many homeowners in designing entry doors. Seen from the outside, the door is a key element in a house's facade, as is a door seen from the corridor in relation to a room and its contents. Things are different from inside, where the door is ranged between the other openings in the walls. The door in the wall has the effect of a counterpart, a kind of placeholder for a person who enters or exits. This correspondence seduces us into engaging in play with its gesture, an example

being especially tall, narrow doors of the kind encountered in official buildings, which give visitors feelings of importance and elevation, while we are otherwise accustomed to the door height being in proportion with that of its user.

2. Alongside structural features, spatial functions are important, and modes of operation in particular, since the use of a door (which besides windows, is one of the few movable elements in primarily static architecture) requires our special bodily involvement. Every door form shapes the procedures involved in opening or closing it and the situation of entering or leaving a room in its own special way. The sliding door is characterized by an inconspicuous sliding movement; the double winged door, in contrast, gives rise to a striking gesture, as one either pulls the two wings towards oneself, spreading the arms out in the process, allowing the now open room to approach, or else pushes them outward, opening up the space of the room with outspread arms. In contrast to the expansiveness of this gesture, a revolving door involves us in a situation of compulsion, with the independent character of the drum's rotation compelling us to treat others with special consideration.

As the most commonly encountered type, the swing door – deployed for rooms, apartments and buildings, all the way to the main entrances of official buildings, as well as for gates and gateways – merits special attention. The swing door is actually a dividing wall that swings on the axis of the hinges by which it is mounted on one side to a door frame, which by framing the wall opening effects a transition between door and wall. The act of opening the door, as an interlocking of building and user, may be characterized as a minor > figure of movement with a decelerating impact and a choreographic expression. If the door opens towards us, we pull the edge of the door leaf towards us with the handle, gradually widening the crack between door leaf and doorway, through which we then enter. In an almost dancelike movement, we rotate our bodies around the leaf of the door, which now extends into

the room, as though with a dance partner whom we hold by the hand, then switch to the handle on the other side of the door, pass over the threshold, and pull the door towards us in order to close it, until the latch falls into place, the act of closure confirmed acoustically as well. If the door opens inward into the room, we enter it together with the door, which now precedes us as we cross the threshold. Only now do we turn back slightly in order to close the door. The movements involved in closing the door, which vary according to whether it opens outward or inward, have contrasting gestural contents. The act of pushing a door closed has connotations, for example of keeping out wind and weather, or of repelling undesired strangers outside, while the action of pulling a door shut behind us resembles that of closing a cape. In both cases, the door represents a gesture and a frame for acts of coming and going.

3. Where pairs of doors are set in the middles of opposite walls, the space between them is traversed by users; if they face each other near neighbouring corners, the room is traversed only tangentially. In a room into which a door opens, it normally lies along the surface of the wall. It can be opened only in one direction, since a rabbit creates a tight seal against air, noise, light and odours.

On the other side, a flat space resides in the reveal, which may be regarded as the most economical form of a transitional space. The direction in which the door opens will emphasize the direction of crossing. And the directional swing of opening will depend upon the axis of rotation, i.e. whether the hinges are positioned on the left or the right side. For the room into which the door opens, this directionality is fundamentally important, since the door, as a movable portion of the wall, either covers and doubles the adjacent wall, or else projects into the space of the room, subdividing it. Josef Frank pointed out that this has both atmospheric and social implications: a door positioned in a corner opens either towards the corner, thereby exposing the middle of the room,

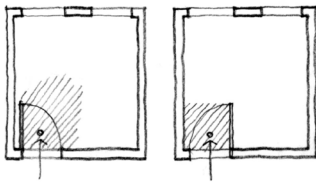

‘so that the entrant suddenly stands there, diffusing unease. If the door instead opens against the space of the room, an entrance creates a natural anteroom between door and wall, and the room itself remains undisturbed.’ (1995, 131)

Dramaturgy

Architecture need not necessarily be dramatic, i.e. charged with tension and capable of arousing emotion. Yet even the architectural impact of a conventional > introduction becomes comprehensible only when consideration is given not just to the succession of rooms, but to the dramaturgy of movement through them as well, to the way in which they combine to configure arrival and entrance. In special cases, however, dramaturgy may aim more explicitly to create an arc of tension, a progression that alternates the heightening and relaxation of tension, and may even lead towards a climax. Various laws of perception point towards the importance of variety in captivating and guiding our attention, with its tendency towards a sweeping, always momentary focus.

Originally used in theatrical contexts, the expression ‘dramaturgy’ refers in general to the elaboration of a plot with attention to dynamism or tranquil permanence, continuity, and the sequencing of scenes. Dramaturgy endows an activity with intensity, avoids dull monotony, and strives to achieve an inner necessity that binds together a > sequence into a totality or convincingly unifies a > figure of movement. In architecture, it is a question of arousing expectations and the building of tension that emerges from them in order to satisfy them or introduce an unexpected twist. Individual situations, however, are conceptualized in relation to a larger spatiotemporal sequence that is in turn regarded as forming a self-contained unity.

A tension-filled sequence emerges, for example, when the structure of a building is unrecognizable at first glance, but is discovered only circuitously, when an exterior contrasts to an interior, which hence astonishes the visitor upon entering,



and which nonetheless seems to form a unity with the outside upon greater familiarity. Also handled dramaturgically are the spatial sequences found in Baroque gardens, where obstacles positioned along a central view axis impel continual detours through which the goal is lost to the gaze, only to be found again unexpectedly, lost again, and then attained in an ultimate triumph. Staircases are particularly well-adapted to dramatic effects, initially blocking views of rooms in other storeys, revealing them only after the labour of ascent, rewarding effort by proffering astonishing interior and exterior views – a striking example being Balthasar Neumann’s staircase in the Bruchsal Palace, the impact of which is heightened by the opposition between the demonic cavern below and the unexpected lightness of the celestial zone positioned above.

Duration

> architecture, event, monument, tectonics, time

Dwelling

Architecture is always a form of dwelling. Alongside other functions, it always faces the task of screening off and articulating spaces so that they are available to people in general terms for the purposes of inhabiting the earth, which is to say, for residence and as a setting for developing their activities. For this reason, it is not only the > residence that constitutes a dwelling. If we – like Martin Heidegger – grasp the concept of dwelling in existential terms, and understand all building in these terms, then we could even say of power plants, spinning mills and motorways: ‘These buildings house man.’ (1953/1993, 348)

The word *dwelling* is suggestive of protection and security against a hostile external world. As an enclosed area, it is meant to provide us with a private space that secures inner peace and tranquillity so that we can assert ourselves in the world outside. Otto Friedrich Bollnow (1963) regards the individual as being ‘incarnated’ in his or her house, regarding as

a second body. Gaston Bachelard (1964/1994) speaks of the ‘motherliness’ of the house.

Peter Sloterdijk (2004) has called attention to the ambivalence of such notions, according to which ‘immersion’ becomes a ‘sealing off in a space’, and the residence becomes an ‘ignorance machine’. In this case, the dwelling not only offers the necessary stability for daily life, one that excludes disturbing contingencies, but also becomes a ‘redundancy generator’ that produces triviality in particular. The authority to dispose of the house as the epitome of property and ownership may on the other hand shift towards imperiousness.



The character of the dwelling is seen in archetypal representations of houses, for example in pictures by children, where the image of the facade alone lacks expressive power, and requires the protective > roof as an emblem of dwelling. In cases where architecture seeks to make an original form seem interesting, or to convey a singular message, the intimacy and familiarity of the house as a home retreats into the background. If the intention is to convey the experience of a protective dwelling, the architectural resources employed must reinforce the emotional content of this experience. Decisive here is the appropriate relationship between containment and openness; the dwelling must offer protection and security while also making it possible to emerge from it into the world.

Literature: Bachelard 1964; Bollnow 1963; Sloterdijk 2004

Elevator

> ascent, cell, intermediate space, stairs

Empathy

‘Our bodily organization is the form through which we grasp all physical bodies.’ With this assertion, Heinrich Wölfflin (1986/1999, 15) claims to explain why architectural objects and forms seem imbued with an expressiveness that is experienced in bodily terms. Through empathy, architecture be-

comes animate, figuratively speaking, meaning that it seems to express specific bodily states, sensations, emotions or characteristic traits of the kind we normally attribute to other living beings. The experience of empathy presupposes that we have already internalized analogous experiences in our corporeal-motor perceptions. 'I assume the presence of my individual life in lifeless forms,' said Robert Vischer. (1927, 21)

According to the view held by Theodor Lipps (1912), however, the word *empathy* (*Einfühlung*) should be understood transitively, and not reflexively, so that a specific mode of human comportment is projected into perceived architectural or spatial forms, which is to say, 'felt into them', and moreover as independent actions of these forms, not an imitation enacted by the beholder. At most, empathy in relation to particular attitudes also stimulates the adoption of corresponding bodily postures, for example when our chest expands in a grand hall, or an upright posture is suggested by a stele. Distinct from the sensations of empathy that arise in conjunction with architectural or spatial structures are associations; these lead further afield, and may be connected only relatively loosely with a given situation.

Alongside experiences of empathy involving virtual movements such as holding oneself erect, contraction or expansion, passive states such as compactness or heaviness may also be 'felt into' architectural forms. Perceptions derived from empathy are also encountered in numerous linguistic expressions that refer to spatial > form character, and in particular to spatial > gestures in terms of bodily traits and processes. A bridge 'swings' across a river, a path 'snakes along', a building 'approaches us' with its facade, and we speak of the 'foot' of a pillar, the 'crown' of a tower. We also encounter frequent links between > tectonic features and empathic processes that render the physical properties of loads and load-bearing amenable to direct experience and comprehension. Wölfflin, for example, explains the expressive qualities of architecture to a substantial degree via bodily analogies, ranging from weight

and its overcoming all the way to various articulations and rhythms.

Perceived differently in relation to a traditional understanding of ‘empathy’ is the sensation of self-expansion within a spatial form or place, i.e. the physical sensation of arrival. Now, the embodied self feels itself expanding into a form (> extension), nestling against or clinging to a curvature, soaring or ascending into a vault or cupola, or so to speak seeping into spatial recesses or branching cavities (> porosity).
Literature: Lipps 1912; Wölfflin 1886/1999; Vischer 1927

Emptiness

> body (architectural), expansiveness and constriction, simplicity, sublimity

Enclosure

> closure, screening, territory

Enfilade

Initially, a > perspective that plunges into depth through a series of rooms in alignment seems to offer a tremendous synoptic view. But only when we traverse the entire sequence of rooms do we discover what each contains, its perhaps astonishing features. When a series of rooms is connected one to the next by openings that lie in alignment, we speak of a suite of rooms or enfilade; the term is derived from the French verb *enfiler*, meaning ‘to string together’. With this architectural configuration, the ‘string’ is the line of sight that passes through all of the openings, which is at the same time a potential trajectory of movement, and allows us to anticipate the linear sequence of spaces. Views into the distance show an echelon of (door) frames.

The perspective of the dividing walls, with their doors, which are staggered into > depth, convey the scenographic effect of stage sets pushed towards one another with their centres left free for > entrances; when the doors are open, an extreme effect of depth is produced which is extended even further when windows are set at the ends of the view axis,

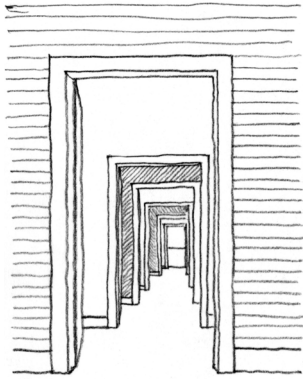

or a continuation of the sequence of rooms is suggested by mirrors. The enfilade reinforces the impression of being able to take in the entire sequence of rooms all at once. Playing a decisive role in contradistinction to the spatial > axis is the explicit articulation into spatial segments. When striding along, the dramaturgical effect of the > sequence is rendered effective by the contrast created by changing room heights and widths and by the varying characters of the rooms (> rhythm). When we look into depth, the dividing walls appear through the openings as a sequence of interlocking pictures, each of which provides a view of a characteristic section of the individual room, if only in the form of a series of variously designed frames.

If the connecting passageways lie along the window wall, while the rooms expand primarily along the other side, one walks with the light to the rear as though past compartments; this mode of regulation causes the enfilade to seem almost as though it were especially conceived for viewing palaces. In organizing an apartment, the enfilade structure makes it possible to generate a hierarchy of degrees of privacy, for instance in princely residences, where we find the sequence of ante-chamber, audience chamber, bedchamber, cabinet and dressing room, and where the articulation into spatial segments forms a scale of degrees of > accessibility. On the other hand, each individual room is susceptible – even when the doors are closed – to being entered from the adjacent ones (> access), which restricts its privacy and subordinates it to special conditions of communication.

Entrance

> door and gate, ingress and exit, intermediate space, threshold

Entrance (theatrical)

In the theatre, an actor makes an entrance when he or she walks out onto the stage, entering the stage and appears pub-

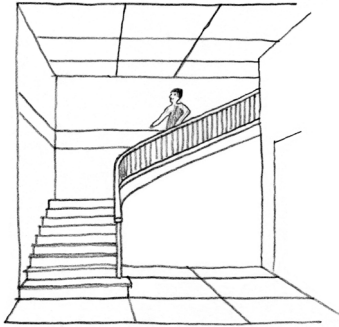

licly. An individual appears in a similar way when entering an urban plaza, provided the architecture supplies an appropriate frame. But an individual who enters a room within a building also makes an entrance, where the architecture supplies the scenic conditions for it. A simple act of > ingress into a room becomes an ‘entrance’ in the sense intended above when it is endowed with significance by the scenic frame, one that may be perceived either as merely incidental or as dramatic. The arrangement of > staircases in rooms or along plazas, the manner in which they lead into space, the positioning of pedestals, spatial guiding and enclosure via > axes, paths or frames, and the possibilities for making an entrance onto balconies or at special > window surrounds: all of these architectural resources contribute to such effects.

In contradistinction to the stage, however, we do not enter architecture solely in order to display ourselves to others, nor to observe others. The capacity of architecture to endow a situation with the character of a > scene does not necessarily call for an audience; instead, making an entrance allows us to become aware of a > situation as a kind of self-enjoyment.

Literature: Janson/Bürklin 2002

Envelope

> covering, filter, incorporation, layering, screening

Equilibrium

> composition, force field, heaviness and lightness, order, sensory perception, symmetry

Erection

> form character, expression, extension, gesture (spatial), heaviness and lightness, movement, postures, tower

Event

The notion of architecture-as-event contrasts with that of the building as a definite, permanent form in two respects. First, it is understood not as an object, but as a process, and second, its eventfulness rests on the singular character of individual conditions within the continuous flux of > time.

First, participating in every > situation that is experienced through architecture, and going beyond the static presence of the building, is a multiplicity of dynamic processes and influences, including > movements and > use, extensions, conversions and interventions. Within a building, there are the > furnishings, with items of furniture and objects of utility, which shape everyday life in continually new constellations just as strongly as the constructed space. Among the influences of the superordinate > contexts, architectural situations as fields of interaction for social praxis also assume changing conditions. Dependent upon diverse practices in this way, architecture appears as a changeable substance that is not embodied in an object, but is only realized in momentary form. The object itself constitutes only a kind of ‘hinge’ (Kwinter, 1993) of relationships.

Second, the eventfulness of architecture is evident in the fact that in it, one always experiences a situation as being singular. The building defines certain framing conditions. But the contribution of the above-named dynamic factors to the formation of these continually different and always at least partially unpredictable situations, to their ‘emergence’, and to the experiences that emerge from them, can never be fully determined through architecture. This perspective is opposed by a functionalist architecture that compels a single, unambiguous usage. Instead, uses result in events through scenarios formed by the contingent and changing superpositions of various activities, external influences, and interactions. A room becomes a contingent space of possibilities in expectation of a use that may ultimately contradict it, since contradictory functions may intersect, and hybrid combinations are possible. Fundamental here is the fact that a spatial situation only becomes what it is through concrete acts of use.

This does not mean, that architectural design is unimportant for the event. The line separating functional determination from architecture as a faceless container in which anything can take place is characterized by the concept of

architectural > capacity. This is a quality that provides space for use-as-event by avoiding defining structure in relation to specific purposes, while exploiting incisive form, for example by means of a specific > type, in order to endow a potential event with an open-ended yet thoroughly directional significance.

Colloquially speaking, an event is a singular moment that is detached from everyday life by virtue of some exceptional feature that calls particular attention to it. This allure of the special, extraordinary, is what we expect from 'event architecture', the spectacular appearance of which removes us momentarily from the ostensible uniformity of everyday architecture and transports us into another experiential world, for example a Tuscan village in a northern European shopping centre. This demand for conspicuous effects and the striking means used to achieve them calls into question the concept of the event and the architecture that strives to satisfy it. Continual exposure to excessive stimulation undermines the stimulus effect and leads towards chaotic noise. This compulsion towards the exorbitant effects attained through theatrical spectacle neglects the fact that the stage function of architecture is also fulfilled when it serves as a background for incidental behaviour. This calls attention once again to more subtle approaches that consider the capacity of spatial situations to accommodate a multiplicity of uses and events of various types.

Literature: Kwinter 1993; Tschumi 1993

Exclusivity

> accessibility and exclusivity

Exit

> door and gate, ingress and exit, tectonics, transparency, wall, window

Expansiveness and constriction

A particularly effective spatial contrast is produced by an alternation between expansiveness and constriction. In contrast

to breadth and height, which can be projected onto a single > plane upon which we gaze at right angles, or to depth, which extends in the direction of our gaze and movement, expansiveness is non-directional. The concept is also distinguished from that of distance, which shifts further and further away from us in the course of movement, thereby remaining unattainable and preserving tension, while expansiveness is experienced and grasped dynamically as it unfolds bodily (> extension).

The counterpart to expansiveness is constriction. Differently from proximity, which refers to relationships of distance, narrowness is a property of spaces that constricts free movement through cramped boundaries or hindrances, and from which we are in turn freed by spatial dilation. Heinrich Schmitz refers to expansiveness and constriction as elementary physical conditions, and has characterized spatial narrowing and dilation as physical sensations (1966, 1967, 1998). A sense of physical constriction is not only oppressive; in weakened form, it holds the body together as a unity, heightening awareness of one's own physicality. Countering this, the breast expands, the self becomes enlarged, one feels a 'largeness around the heart'.

Decisive, to be sure, for an impression of expansiveness is > size, but such effects do not emerge simply because a space is large, but instead because it continues beyond boundaries which seem to dissolve, for example in the 'unbounded interiors' of the Baroque, where one tends to wonder whether anything solid exists beyond layers and vistas (Bollnow 1963). Ulya Vogt-Göknil (1951), describes the effect produced by a hovering, evanescent atmosphere, when everything solid, corporeal, is transformed into the purely planar, and delimiting walls touch the floor gently without actually resting on it. Seemingly suspended walls have no > weight, they appear to float, to experience a virtual expansiveness. On the scale of the > landscape, expansiveness is among the most defining impressions. An additional dimension of expanse is

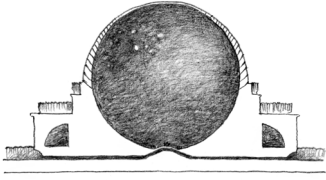

experienced in spaces that not only open on all sides, but also spread themselves out below, as in mountainous terrain. The sublime effect of danger, lostness and boundlessness is also produced by darkness or twilight, and can be imagined as the type of spatial sensation experienced inside of Étienne-Louis Boullée's Cenotaph for Newton.

Conversely, a space is not experienced as confined because it is small; according to Vogt-Göknil, the constricted quality of a room is produced by a concentration of solid, pronouncedly heavy, impenetrable physical masses and an impression of extreme downward-pressing weight. The > density of > materiality is also experienced as closure. Under ubiquitous pressure, the space appears compacted.

Likewise, the degree to which spatial dimensions have an influence on experiences of constriction or expansiveness is dependent upon the spatial context. Narrowing a space at points, or in a short passageway, a minimal cross-section – one that would cause a long corridor to appear decidedly narrow – is effective merely as the caesura of a spatial sequence. The dimension of breadth stands in relationship to height, so that a breadth that would seem normal in a village street would appear as a narrow alleyway when found between tall buildings. The contrast between expansiveness and constriction is experienced through the rhythmic alternation between spatial contraction and expansion. The two stand in a complementary relationship, conditioning and enhancing one another. Strolling along a columned hall, for example, the contraction between pairs of columns and the regular expansion into intermediate spaces or side chapels are repeated in ways that are analogous to the periodic contraction and expansion of respiration. More lively is the > rhythm found, for example, in the irregular spatial flow of the sequence of public squares in a historic town.

The > dramaturgy of movement sequences profits from contrast: after feeling oppressed by the extreme narrowness of a passageway, we experience the subsequent widening out

as a liberating release. A continuation through open space accommodates the drive towards expansion of our > personal space.

Literature: Schmitz 1966, 1967, 1998; Vogt-Göknil 1951

Experience

The decisive thing is the way in which architecture is experienced. Upon entering a café, we notice the striking colour of the counter in passing. What we actually see, however, is not just its colour, not its squarish shape; we perceive the counter in its immediacy. Strictly speaking, we cannot even isolate the counter from the other elements that make up the room: the walls, the curtains, the flooring, their colours and forms. To be sure, we perceive all of these elements, but what we actually experience is a room in its overall appearance – and moreover not as formed volumes, but in its specific character, together with the other individuals who are present and the particular atmosphere we encounter immediately upon entering the room, without distinguishing details, as a total impression. Upon entering, we are all aware of how our sense of space, our personal sphere, seeks to engage with the space, how it expands either hesitantly or instantaneously, taking in the space and feeling it out or filling it up in its various directions and forms through the spatial > extension of our own subjectivity. For the most part, architectural phenomena can be characterized through the specific unfolding of such processes.

It will be claimed, to be sure, that in contrast to elements such as screens (> screening), walls and > openings, architectural space is a fiction (Feldtkeller 1989). In fact, however, we experience these elements as space, and in particular as a corporeal being-in-space. This ‘as’, which is expressed in phenomenology as intentionality, through which we attribute contents to every perception, also conditions our experience of a room’s character, as having a specific function (coffee shop), for example, as an invitation (consume!), as a symbolic effect (a brand), or an emotional appeal (cosy).

That a room is experienced as architectural space is not dependent upon its characteristics and elements as such, but instead on the type of experience that is involved. Dagobert Frey has said that to ‘identify the essence of architecture’ means to determine the specific way in which we experience it, specifically in contradistinction to the aesthetic experience of images. A work of architecture does not stand across from us like a picture; instead, we ourselves belong to architectural reality, so that instead of being mere beholders, we enjoy the status of ‘actors’. As a social discipline, on the one hand, architecture generates complex situations in which we participate through our diverse states of mind and motivations and through individual and collective behaviour. On the other, situations are influenced, articulated and reflected by architecture through its forms and spaces, its atmospheres and meanings.

Because these situations contain self-reflexive moments (we perceive ourselves within them), an aesthetic perspective now comes into play, i.e. the distanced self-awareness of the situation for its own sake. Although in the context of habitual and incidental everyday perceptual experience this aesthetic point of view remains subliminal, it does rise to the level of explicit expression when one asks oneself how one ‘is’ in a certain place, when one becomes aware of feeling exposed, stimulated, or simply ‘good’ in various spaces. Helmut Plessner’s general definition of a human individual’s relationships to the world as ‘excentricity’ claims that fundamentally, we are disposed towards self-awareness in relation to our own actions: ‘What is my body, which obeys my will, other than an active figure, which I perceive like the figure of another [...] Simultaneously actor in a scene and spectator.’ (1923, 41) For the scenic character of this self-reflexive experience, architecture so to speak offers a stage (> scene). Since we always experience architecture as a situation, the role of its elements is explained more fully through a characterization of our intercourse with them than through their description as mere

objects. A description of views into and/or from a building, for example, explains the meaning of a > window, while a > door is experienced architecturally by being opened, closed, and traversed.

An ‘experience’, on the other hand, is an individual experiential event that is endowed with special meaning. While the artificial, virtual worlds – which our ‘event society’ offers as alternatives to everyday life – are often staged via architecture, examples being the ‘themed restaurant’ or ‘adventure swimming pool’, great architecture is always an experience.

Literature: Baier 1996; Dürckheim 2005; Frey 1925/1946; Kruse 1974; Rasmussen 1959

Expression

It is not primarily rectangles, circles, cubes, cylinders, or straight and curved lines that we perceive in architecture, but doors, windows, staircases, walls and roofs. Coming to immediate expression in these elements are further qualities: the inviting character of an entryway, the steepness of a staircase, which suggests the physical effort needed to ascend it, the closed appearance of a facade, the protective gesture of a roof etc. We immediately grasp that which architectural forms and situations express – not as concealed essences, but through the impressions they make on us. The expression of individual constructive and spatial forms is enunciated through > form character. In contrast, what we experience as the expressive content of a total spatial > situation is its > atmosphere.

As the immediate expressive qualities of constructive and spatial forms, and in contradistinction to those > meanings that are suggested mediately, form characters appear as qualities of the architectural elements and forms themselves. The expressive content does not reveal some concealed subject matter to which access must be gained through the form; instead, the building’s character comes to expression when it becomes directly perceptible through its architectural gestalt. Architecture should be distinguished from other domains be-

cause here, expression rarely emerges directly from the structural form itself, but instead as a rule from the overarching spatial situation, one to which human actors contribute as well. We grasp the expressive character of a situation, its atmosphere, instantaneously, without reflection; contributing to this experience are the individual characters of built and spatial forms.

In many cases, form character cannot clearly be distinguished from atmosphere: in expressive terms, there is much overlap between the upwardly striving character of a pointed arch, for example, and the rising and uplifting atmosphere of a Gothic church interior. Both are composed of various expressive qualities. Contributing to form character, for example, are not just formal features, but also qualities like > materiality and > colour. The atmosphere of the total situation, by contrast, encompasses additional communicative functions such as > orientation or > spatial gesture. Atmosphere, in particular, but also form character, are shaped by general sensory impressions with their synaesthetic extensions, as well as by qualities of mood and > appeals. Other meanings, such as those conveyed by > images or > symbols, may be effective in expressive terms as additional components of form character or atmosphere.

In contrast to semiotic meanings, which can be conveyed independently of concrete situations and interpreted objectively, identified in iconographic terms or classified typologically, immediate expressive qualities remain at times quite diffuse, and are less amenable to examination. As indissoluble components of built forms and architectural situations, however, they influence us inescapably, and have a more direct influence on our concrete experiences of architecture than those meanings we attribute to objects through conscious acts, or must read out of them. Expressive qualities, in turn, may themselves function as > signs: a sober, rational design can be an expression of sobriety, and at the same time a sign of modernity.

Extension

We do not reach towards things solely by means of the gaze; instead, the entire corporeal sphere extends outward into space. In the process of perception, consciousness extends as far as the senses can reach, and our bodily presence expands with it. Not in the sense that I am here, and a dark area beneath the trees – which I can see from here – is over there; instead, it is as though I extend myself as far as the area beneath the trees. But not in such a way that I only imagine that instead of standing here, I stand on the other bank of the river, beneath the trees; instead, I am here, but at the same time reach out with my bodily self all the way to the trees over there.

To be sure, the gaze extends towards objects in space, but it is not only ‘the visual ray that encounters the object at its actual spatial location’, as Helmut Plessner says, reaching towards it and ‘through this reach, giving the organism the radius of movement’ (1923, 247). We also grasp the spatiality of architecture, with its cavities, intermediate spaces, and openings, by imagining penetrating them physically or nestling against them. According to Plessner, we also experience paths and roads via such virtual anticipatory movement: ‘To nestle against, to accompany, to probe, to be filled with, these are the thousand ways of living in attitudes [...] are the means we understand architecture.’ (249)

While in > confrontation with walls, the extension of our > personal space experiences resistance, niches, apertures and spatial extensions yield to us, so that the projection and recession of the spatial envelope is experienced as receiving an impression of the space of the self, which pours itself, so to speak, into the form. Admittedly, this virtual rapprochement is not generally experienced as a flowing interpenetration without resistance, but instead as a tension that bridges a distance, or as a striving to overcome a ‘viscous’ medium (Gosztonyi 1976, 1249). This tension is also dependent upon the formal antagonisms, resistances and discrepancies of the geometric spatial shape in relation to one’s own physical

disposition. The built 'blob', on the other hand, simulates the personal spatial 'bubble' in a tensionless way. For our movements as well, the forms and articulations of rooms, with their obstacles and their openings, constitute complementary forms in relation to which our room for manoeuvre stands out, and which can be imagined as potential > figures of movement.

The phenomenon of extension is of enormous significance for most architectural situations. In many instances, that which we perceive in the > concavity or introversion of spaces, or in their > directionality, their gestural character (> gesture), or > expanse, the way in which we experience > form character, the > porosity of built forms, and many other spatial effects, is graspable only through some conception of the expansion of our personal space and its extension.

Already from a distance, I see an armchair not simply as an object, but as a vessel-like complementary form that is ready to receive my body in a seated posture, in which I already sit in a virtual sense, already feel comfortable or discomfited respectively, as I am likely to feel there. In walking along a path, my body always anticipates my imminent steps, and I know well beforehand which foot will step onto a kerb, I see myself reaching my goal as soon as it appears in front of me. I experience the broadening and narrowing of spaces, for example the > rhythm of the intervals between pillars in the nave of the church, as the broadening and narrowing of my physical space. My erect posture extends all the way up into the cupola. The cavity of the exedra captures and focuses my imaginary expansive impetus. I recreate the arching volumes of Baroque spaces imaginatively by arching the contours of my personal space. In the hollow spaces of small niches, by contrast, I must extend many small antennae.

Literature: Gosztonyi 1976; Merleau-Ponty 1962



Fabric

> density (spatial), space-body continuum, urban design

Facade

The word facade is derived from *facies*, the Latin word for *face*, and refers to the outside wall of a building. The term's anthropomorphic provenance is suggestive of various analogies, all related to that which a facade conveys to someone standing across from it. A facade's space-shaping and communicative functions are inseparable; particularly relevant are its independent spatiality, which has an impact on both interior and exterior, its projection of a spatial zone of influence into the outside space, and its contribution to delimiting streets and squares.

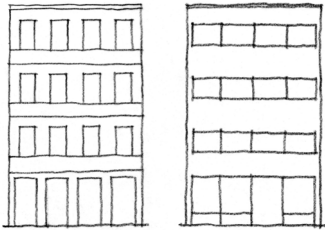

Facades are highly visible outside walls that are capable of addressing those who face them, of shaping an address, and of reflecting a building's unity. To serve these functions requires a painstaking design that maintains a strong identity when viewed as a whole as well as close up and in detail. By emphasizing its division into storeys, and articulating the pedestal and attic zones, the facade facilitates the readability of the building's tectonic structure. The facade, however, is also the location of the artful treatment of the planarity of the outer wall: decisive for perforated facades is the weighting and > proportions of the wall surfaces and openings, and for curtain wall facades, the structuring of the facade grid. The relationship between height and breadth as a whole and the arrangement of the parts may for example give expression to a vertically striving > directionality, while a recumbent > gesture is suggestive of a horizontal gliding movement.

With its planar > composition, three-dimensional articulation, relief-like > layering of wall levels, and configurations and rhythms of the individual elements, the facade offers an initial impression of the building that is set behind it. Suppressing such a relationship, however, is the media facade, which functions as an independent image or projection screen.

The impression made by a facade depends upon its location and surroundings. Viewed frontally, it confronts us directly (> confrontation) in ways that incidental viewing

generally avoids, and is inviting or aggressive, provocative or expectant. An oblique approach has instead the effect of guiding the beholder further, one that is emphasized by the horizontal elements, and may be taken up by adjacent buildings. Depending on distance, we may enjoy a complete overview, or partial visibility may require a successive and scanning mode of perception. Our impression is also conditioned by the mode of traffic that prevails in front of the building: the experience of a pedestrian strolling in a public square is different from that of the driver who, depending upon velocity, may perceive only an indistinct blur or fleeting, emblematic image. From above, i.e. from an aeroplane, mountaintop, or neighbouring high-rise, the surface of the roof acquires importance as a 'fifth facade'.

The facade may express a building's character in a restrained fashion, or call attention to it. Like a human face, it expresses personal identity and recognizability, and displays a certain inner constitution, at times like a mask, one that – whether playfully or with deceptive intent – endows a building with a changing identity. This analogy extends all the way to physiognomic expressive values or anthropomorphic correspondences of elements, with the entrance appearing as a mouth and the windows as eyes, for example. Whoever lives in a building is aware of the face it presents to the town through its facade.

A facade advertises the interior space behind it, initiates the act of entrance, and prepares visitors for what they will encounter inside. Rather than showing the visitor what he or she can expect to encounter within, the facade may engage in concealment or allusion in order to build a sense of tension that will dissipate only after one has entered. Essential to this experience of approach are those elements that confront the beholder in front of the facade level. A projecting portico, protruding pedestal, overhanging roof, or entrance niche all call attention to the entrance, providing it with comfort.

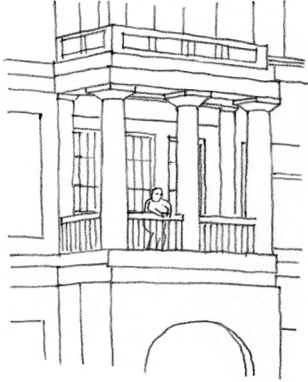

The facade casts its > space shadow onto the area lying directly in front of it. It functions as a direct backdrop or stage rear wall for the enactment of everyday urban life. The facade itself is a stage for making entrances, i.e. at windows and doors, on roof terraces or balconies. Formed as a > space-containing wall in a ‘multilayered’ (Hofer 1979) urban space, it belongs simultaneously to a building’s interior and exterior, and makes possible spatialized interactions between > inside and outside. Examples of constructive artifices are projecting structures such as > arcades, > galleries, balconies, trellises and wall > layering. By containing space and through > pochés in the facade, the discrepancy between the contours of the outer and inner spaces can be balanced, and each zone guaranteed its spatial identity.

If it is to work together with neighbouring facades and function effectively from both proximate and distant viewpoints within the larger urban landscape > context, the facade design must be attentive to the most diverse orders and scales. The spaces of the city, its streets and public squares, are contoured and formed by the > surfaces of multiple facades set into relation to one another. Independently of the buildings lying behind, the space of the street is legible as a continuous space that is lined with ennobled surfaces. The facade may even acquire a certain degree of autonomy as a three-dimensional form, so that it becomes almost independent of the building behind, as in the curved church facades of the late Baroque era.

The richness of spatial references and forms of spatial experience that are objectified in the elements of the facade call for the multidimensional communication of contrasts: of planar composition and shallow space, projection and recession, confrontation and permeability. The architecture of the facade particularly fulfils the function of conveying social messages via a dialogue between the private space of the building and the public space of the city.

Literature: Kemp 2009; Neumeyer 1995; Stephan 2009

Field

It is possible to distinguish two types of field character; effective between masses in one case is a kind of ‘gravitation’ (> force field) (1), while decisively in the other is primarily the position of the figures on a ‘playing field’ (2).

1. ‘A field theory of architectural space’ describes the effects of perceptual forces between architectural forms. Rudolf Arnheim (1977/2009, 16ff.) uses the term ‘field’ for architecture here in a way that is analogous to other field theories. According to him, a field is not merely a planar territory; arising from it are potentials, forces and field qualities. In architectural perception, forces of attraction and repulsion between architectural bodies or states of pressure and tension between the walls of a room are perceived as a field of energy gradients. This play of forces, as an essential component of perception, permeates the field where forms, architectural bodies and spaces are interrelated. We can imagine the relationship between them as a dynamic structure within which each individual element occupies a specific position by virtue of its form, dimensions and alignment, and confronts other elements with its own mass. Dominance, connectedness, confrontation, and the drive towards expansion are perceptual forces that are effective between architectural elements within a field. Within this force field, each element influences the others, and in particular the spatial relationships between them.

On this field, we are corporeal figures that likewise participate with our bodies in the play of forces. Large architectural masses exercise a kind of gravitational force on other masses, and on our bodies as well. Existing between building fronts that face one another are fields of tension to which we are exposed when we occupy the intermediate space. Convex forms are surrounded by concentric force fields through which they press towards us. Concave forms take us into their embrace. Also active as players, so to speak, on this field alongside human protagonists, are buildings. If a building is removed or a new one added, all of the existing relationships may be displaced as though on a chessboard when a pawn is

exchanged for another figure. In the other type of field, this playing field characteristic becomes the principal feature.

2. In those instances where buildings assume no notable role as actors on the playing field, it is less a question of the play of forces involving the heightening and relaxation of tension or of attraction or repulsion between masses, and more of the positions on the field that one assumes, traverses, or towards which one strives. Inscribed onto fields via the traversal of positions are the spatial figures of movement that are executed through one's own movements according to an individual or collective choreography of everyday life. In the absence of the pronounced presences of buildings, the characteristic field experience is generated solely by one's own actions, by the choice of position, orientation and movement in relation to a field geometry. Structurally, such a field character is dependent upon the circumstance that in contradistinction to a force field, the architectural masses exercise only a minimal spatial influence, for example by virtue of their inconspicuous, neutral design, or of the substantial distances between them, as on the expanses of unarticulated surfaces of some public squares, as well as in nondirectional, homogeneous, or loosely organized structures, such as the prayer halls of mosques, with their uniform subdivision by means of columns.

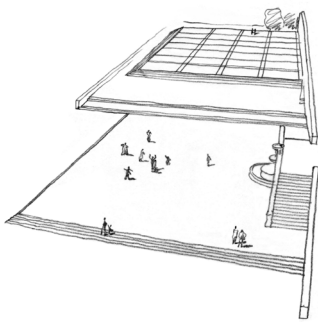

In its most reduced form, a field is delimited only by non-material boundaries like a soccer field. Here, the ground is the plane upon which positions with various properties are located. But this playing field is endowed with certain properties of a force field. Even on an open rectangular surface, gradients emerge from edges, corners, diagonals, midlines and centre. Through distance and alignment, all of the positions on the field are oriented towards these. They are superimposed through individual or collective positionings and through the movements of people, which may in turn bring a variety of orders into play. On this stage, one's own body is a mere playing figure that takes up positions, generates directional refer-

ences, or moves in a free, > roaming fashion. In contradistinction to a structure of tension between masses within which our own bodies are confronted by other bodies in space, we retreat with our bodies behind our role as players. Unconstrained, freed from the gravitational forces of architectural masses and the influence of walls, without being guided along paths or channels, one follows one's own impulses towards movement. In this respect, a playing field is related to a dance floor. In some instances, the conventions of ceremony supply the rules of the game for movement on open squares and in large halls.

Figure of movement

A performative counterpart in architecture to defined spatial configurations is the corresponding figures of movement. Comparable to the way in which a pattern of dance steps, guided by music, shapes bodily experience, such figures consist of characteristic sequences of > movements guided by the built design and grasped and stored in bodily memory as > gestalt schemata, which can be performed again later as needed. The significance of figures of movement for architecture, which goes beyond visual perception, is emphasized by Goethe: 'In dance, we experience pleasant sensations while moving according to certain laws; a similar sensation ought to be evoked in a person who is led blindfolded through a well-constructed building' (1795/1973, 108). In actual > use, architecture is primarily shaped by specific and often recurring patterns of activity and schemata of movement, while visual form remains in the background. Basically, as Karlfried von Dürckheim has demonstrated, every spatial structure generates a 'counterform' consisting of real or potential movements that are reflected in a 'movement formula' characteristic of the respective space (2005). Acquired through gradually increasing familiarity, they offer security of movement.

Even the smallest units are identifiable as elements of figures of movement. The climbing of a > staircase, for example,

already presupposes a gestalt-like conception of the elements that combine to form the process of ascending an individual step, and which allows it to be repeated automatically. The same is true of the act of stepping through a doorway (> door), which involves the performance of a sequence of stereotyped movements that could almost be performed without sight. Faced with the respective constructive elements, the > body recalls the necessary repertoire of movement schemata. Corresponding to the open form of a > field or the uniform and dispersed distribution of supports in a hypostyle-type > hall is > roaming movement.

Among more formalized movements, linear routes are relatively simple figures. Here, movement is synchronized by a regular sequence of form elements, for example a succession of supports. Or they acquire a rhythmical character through the alternation of narrower and wider spatial sections, as investigated by August Schmarsow in the context of the perambulation of a basilica (1915, 33–46).

An extension of the figure of a linear route is the oscillating back and forth movement that encourages continuous thought and meditation, or discussion and disputation. Its form offers the security of directionality and a fixed rule for gratuitous repetition, so that no decision concerning direction is necessary, and the mind is free to engage in contemplation or conversation. The repetitive movement of > circulation, for example, in a cloister, is stabilized in a similar way. A movement > sequence is composed of several figural components. When leaving the house, for example, one takes a few steps through the corridor, opens the door, turns to the left, descends a couple of steps, makes a turn to the right, opens a second door, and steps out onto the street. Soon, such everyday sequences of movements congeal into figures that could be easily mastered in one's sleep. A figure of movement facilitates > orientation when it functions as an incisive configuration of > access, for example in the characteristic figure of a loop or another incisive configuration, thereby allowing the

> spatial structure of an architectural layout to become intuitively clear.

The interplay between figures of movement and built form is constitutive for architectural > gesture. There exist situations whose > atmospheres as a whole are borne by gestural impulses, so that the dynamic expression of the built form elicits specific movements. The gestalt-like incisiveness of such architectural gestures rests on the especially manifest correspondence between figure of movement and spatial design.

As central elements of a ceremony, figures of movement are deployed as bearers of meaning of additional content, for example lordly or sacred ones. The architectural reinforcement of such ritual actions are found, for example, in the design of the sequence of supports along procession routes, in the dramaturgical potential of Baroque staircases, and in the stop-and-go character of the approach to the Acropolis via the Propylaea as described by Jürgen Joedicke (1985).

Literature: Dürckheim 2005; Jäkel 2013

Figure-ground relationship

> body (architectural), context, gestalt, poché, space-body continuum, urban design

Filter

Through a filter, two spheres are separated and, as a result of its permeability, at the same time reconnected with one another. Just as the word's etymology suggests (to 'filter' something is to allow it to pass through felt), a selection comes to expression as though through a sieve; in architecture, a filter between inside and outside or between individual rooms is partially permeable to light, air, noise or movement. This filter effect is articulated in architecture in multifarious ways. Examples are the positioning of rows of columns and supports, grid or lamellar structures, the sashes of subdivided windows, more-or-less permeable types of glass, and textiles or screens

made of paper (shoji). The filter layer itself can assume various dimensions, and may form a > layering with its own spatial extension (> space-containing wall).

On the one hand, filters demarcate separations, on the other, they modify our perceptions; depending upon the constitution of the filter, individual modes of perception are filtered out, i.e. seeing through glass without hearing, listening through thin, opaque wall screens without seeing. As modulators, window shutters in various positions regulate the permeability of window openings. Graduated differentiations admit light, for example, while closing off the > gaze towards the outside or allowing only schematic views, securing privacy while providing hints via the play of shadows. The curtain effect, achievable through lamellae, latticework and mesh structures, allows views only from dark into lighter areas. This not only veils views from the outside, but also weakens the incident light or causes it to vibrate. Venetian blinds, for example, allow views towards the outside to be finely controlled while allowing occupants to remain invisible from the outside. Fresh air is allowed to enter, while the public space outside remains obscured. Within, the unifying effect of the light, fragmented into stripes, blurs spatial boundaries and produces shimmering atmospheric effects.

By fragmenting sensory impressions, differentiated filter systems activate and develop the contributions of the individual sensory modes in a targeted way. In the Japanese house, for example, in contrast to the explicit definition of the function of > openings in western culture (i.e. > door = exit, > window = views, > wall = separation), the functions of doorways and windows are blurred. They are not kept distinct from the dividing function of the wall; instead, screens, sliding doors and shutters become gradually adjustable filters. Seen from the inside, filters generally have the ambivalent effect of gratings and fences: as barriers to the outside, despite their permeability, they create feelings of security, but may also attribute to sensations of confinement. From the outside, the effect is

suggestive, mysterious, as with all forms of concealment, and exercises a certain allure. Whereas a curtain, at the same time, generates scenographic effects.

Strictly speaking, the house or apartment door too is a filter. It is permeable only for those who belong to the house, and can be locked and unlocked as desired. Most types of filters, however, present no sharp spatial boundaries, but instead render them diffuse, decelerate them, or facilitate a form of flowing transition (> intermediate space). Filters offer resistance to the crossing of a > threshold. For the observer on the other side, they generate effects of surprise when it is crossed unexpectedly.

Literature: Auer 1989; Beyer/Huber 2000; Stalder 2009

Fittings	> furnishing, interior, residence
Flight of rooms	> depth, enfilade, perspective
Floating	> heaviness and lightness, light
Floor	> base, ceiling, colour, flowing space, ground, plane, territory
Flooring	> ascent, ground, materiality, movement

Flowing space

Ever since the ‘destruction of the box’ by Frank Lloyd Wright, the room as spatial container has begun to leak. Precisely the breaking open of the concave elements of the corners of a room deprives the enclosure of its stability. In particular by abandoning space-containing outer walls and instead using floor, ceiling and wall planes that are interlinking spaces (Mies van der Rohe, de Stijl), through freestanding wall panels (> plane) or supports in interiors, and finally through various types of > transparency, interior spaces are fused with one another and with the space outside.

The discourse on ‘flowing space’ imputes an apparent movement to the room as an expressive quality. More precisely, we actually experience this ‘flow’ through our own movements; it tends to dissolve the boundaries of our own

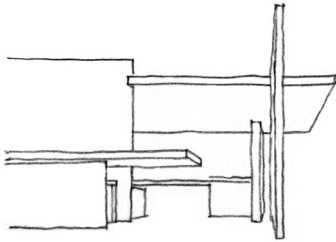

> personal space, which is able to expand further when our room for manoeuvre is not restricted by spatial delimitations. With their open or staggered arrangements, of course, rooms whose boundaries have been broken open, whose walls no longer form closed contours or containers, do inhibit spatial expansion at certain points, but never block it entirely. Also contributing to metaphorical images of flowing movement is the likewise ‘flowing’, visible spatial medium of > light, which permeates a room via intermediate spaces, penetrates walls, is reflected, and carries the beholder along visually even when he or she does not engage in movement. The interplay of continuous space, light and spatial expanse within a dynamically structured texture can convey the experience of a delightfully free yet guided movement through space.

It is possible to prevent a space from ‘flowing away’ entirely by selective, compact arrangements of separate three-dimensional or planar elements so that even in flowing spaces, zones with suggested enclosures are formed. This is decisive in particular for the recognizable framing of urban spaces with amenity qualities, which otherwise threaten to collapse into an accumulation of isolated objects between spatial voids and traffic streams.

Literature: Zurfluh 2009

Folding

When a surface is folded, one side is reversed into the other. Each time, a certain volume of space is folded into it. In cases of multiple folding, convex and concave sections alternate, so that the space on one side is interlocked with that lying on the other. One is everted into the other, and vice versa. Folding, then, is a process by which in principle > inside and outside or above and below interpenetrate by means of a folded dividing surface. In particular, the interrelationship between spaces achieved thereby provides a basis for spatial > inversion. When one lingers inside of spatial folds, one finds oneself in a zone that projects into an adjacent space and is surrounded

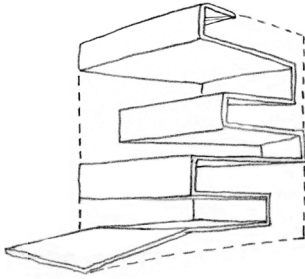

by it on several sides without actually belonging to it. The relationship between spaces that are folded into one another in this way amounts to a complicated (French: *le pli*, fold) form of > screening. Multiple folds form > space-containing walls. With vertical spatial transitions, floors or levels can be folded in such a way that in place of separate horizontal levels, we find flowing transitions between them, as discrete divisions between floors are abandoned in favour of continuous movement, an example being the design of a library for the University of Paris at Jussieu by OMA.

Folding is a procedure through which forms respond to one another flexibly, flow into one another, or in general allow room for manoeuvre between them and in relationship to their contents. In architecture, in ways that are analogous to the way folds in garments yield to allow space to form between clothing and body, a building may accommodate challenging physical or programmatic framing conditions by displaying the flexibility of folds in the figurative sense, may ‘bend instead of breaking’ (Lynn).

Literature: Lynn 1993

Force field

According to Rudolf Arnheim, even when an architectural space is not seen, it is nonetheless perceived through the ‘Intuitive force’, and depends upon it (1977/2009). The dynamics of such powers of intuition are characterized by Arnheim as an essential component of every perceptual act that goes beyond mere sensory stimulation: ‘The play of forces *is* the object of perception.’ Space is not empty; instead, we perceive the forces between the forms as influencing the space between walls and architectural elements, as well as our own standpoint.

Arnheim describes the impact of such forces in detail: already the spatial relationships between an object towards which one moves and one’s own position is imagined as a linear connection, one that is set off from its surroundings.

Between three isolated objects, we perceive the > gestalt of a triangle. The space between architectural elements, then, does not remain empty, but is instead perceived as a figure. Together with the neighbouring house, a house forms a common 'perceptual image' to which the intermediate space belongs, together with its perceptual form. We involuntarily assume a relationship between structural parts. This consists not just in a dynamic relationship between various > sizes, but also in the various levels of > density of the intervening space. Depending upon the spacing involved, the pressure between them may be heightened or diminished; they are attracted to or repelled by one another. Forms that are capable of agglomeration can link up with one another, dynamic forms require room to manoeuvre. The cylinder has repelling, forward-propulsive impact, its force radiates concentrically outward; depending upon their > form character, other architectural volumes likewise exercise an influence on their surroundings. Buildings 'occupy' space, demarcate and defend it. An interior space too is defined by the relationships between walls, corners and centre, by the position of openings and movement trajectories, is thus articulated by gradients in a > field of forces. The space around a building, between architectural volumes, and within walls, then, is not homogeneous, but is dominated by the energies of a force field.

An individual who remains and moves within this force field is exposed to its impact. The space-shaping figure of a wall with the floor area in front already makes itself conspicuous as a palpable zone of influence marked out by a > space shadow, and the same is true of the > angle of a corner. Within the > confrontation between two building facades, we are submerged into a field of tension that is dominated by these structures as though by two antagonistic fronts. Through their sizes or designs, other buildings demand a respectful distance. From an axial layout, one receives instructions for approach; some buildings invite dialogue. In the absence of any kind of structural scaffolding, for example on the surface of a

broad, undivided public square or in the middle of a confusing distribution of structural elements that lacks any system of references, one readily begins to feel slightly lost – or perhaps instead takes pleasure in the experience of > roaming.

Literature: Arnheim (1977/2009); Seyler 2004

Forecourt

> courtyard, intermediate space inversion, square and street

Form

> body (architectural), form character, gestalt

Form character

For the most part, putatively objective descriptions of forms also highlight their expressive characters. At times quite unintentionally, this expressive character is betrayed by the descriptive language that is employed. In many cases, forms are describable in no other way. When we refer to a form as jagged, for example, and to another as convoluted, such characterizations say little about angles and curves; instead, jaggedness or convolutedness is the > expressive content of the form, its form character.

Where this character is elaborated in design terms so that it is clearly manifested through form, then rooms, architectural elements, and entire buildings emerge from them and confront viewers with an unmistakable character. Gernot Böhme refers to such expressive qualities as the ‘ecstasies’ of things. It is not, however, that their inner, concealed essences are now allowed to emerge into view; instead, their expression corresponds to the impression that is evoked through their characters. In the doctrine of characters found in French architectural theory of the eighteenth century, the term *caractère* referred to the expressive function of a building. Architectural form, spatial configuration, proportion, and decor were to have given expression to a building’s purpose.

The more general term *form character*, on the other hand, refers to the expressive function of individual constructive or spatial elements, while the term > ‘atmosphere’ refers

to the expression and character of the total architectural situation. Form characters are components of atmospheres; as a consequence, both encompass common expressive qualities. We do not attach these to the forms subsequently through interpretations or associations, but instead experience them directly as perceptible form. They can be distinguished according to their formal properties in the narrower sense (1), other qualities or properties of objects (2), dynamic effects (3), sensory impressions (4), mood qualities and appeals (5), and expressive qualities that are conveyed indirectly (6).

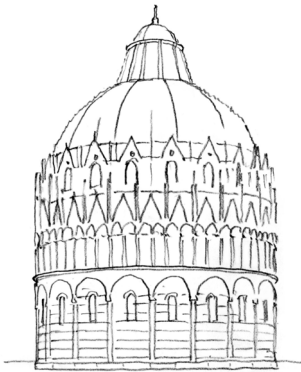

1. Generated through purely formal traits, for example, are rounded, pointed, or compact characters. Compositional qualities determine whether an architectural or spatial form makes a uniform or fragmented impression, and allow a specific formal constitution to be recognizable. For an impression of > size, form and dimensions are equally decisive; bigness, for example, may come into its own through the design and shaping of bulging forms, while scalar relationships and > proportions may cause a form to seem elongated, compact, or well-balanced.

2. Strictly speaking, weight, material and construction do not belong to the formal characteristics, but the expressiveness of forms is often strongly influenced by such factors. By emphasizing the weighty character of a form, its > heaviness comes to full effect. Dependent upon > materiality are, for example, the expressive qualities of > porosity or > density, while > tectonics as an expression of construction determines whether a built form seems to bear weight, to hang, or simply to rest.

3. According to Rudolf Arnheim, dynamic 'perceptual forces' are always effective in cognition upon which form character are largely dependent. When a building is said to 'soar' or a square to 'spread itself out', language attributes autonomous behaviour to inanimate objects. Yet not every building soars upwards; some rest, crouch, bend, recline, or sandwich themselves between other structures; and a square

might not spread itself out, but may instead extend, align itself, wrap around a building, or seal itself off. In our imaginations, such behaviour is not added to the form as an external activity, but is instead grasped as a property of the form itself.

Even the simplest element, such as the edge of the house, appears to ascend or to fall, to lead us around or to close itself off. Walls run parallel to one another, approach one another, deviate from one another, or curve. A ceiling either sags downward or allows the space to grow upwards into a vault. In many instances, a form also expresses its attitude towards its surroundings. Convex hollow forms bulge outward or expand, or push against others; concave forms open themselves up, create a sense of pull, or enclose (> concavity), while plane surfaces are adapted to being conjoined. Neighbouring form elements are linked to one another, i.e. where continuous edges or surfaces seem to be extended, for example a steep roof into a vertical wall, or a continuous form of connected roof surfaces. Individual elements or parts of forms are shifted into one another, descend, or rise in relationship to one another; spaces and architectural elements interpenetrate, are superimposed, or fuse. The sense of movement inherent in a building – when it is conceived as a living organism – also shapes its form character. Marginal cases of this dynamism include the traits of immobility and expressive quiescence. All of these dynamic attributes are expressive qualities of individual architectural or spatial forms.

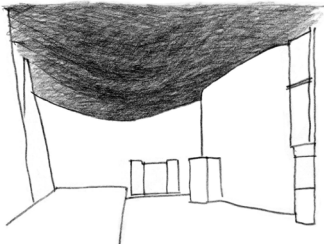

In many instances, however, it is impossible to separate them from an overarching spatial > gesture, although this unfolds only in relation to the atmosphere of a total situation, and in ways that affect our behaviour.

4. For form character, a substantial role is played by expressive qualities that are based in sensory perceptions, and which are in many cases transported via > synaesthesia. Softness, for example, is an expressive quality that contributes to the character of a built form at least initially through tactile

or surface qualities. A soft contour, however, may distinguish the expression of the total spatial form or building, and the same is true of soft lighting or a corresponding coloration or sound.

5. To begin with, mood qualities have no relationship to formal traits, but nonetheless, some building forms are serious or comical in character. When we feel ourselves addressed and affected directly by expressive qualities, for example through the aggressive, thrilling, or inviting forms of buildings or spaces, then we speak of > appeals.

6. At times, a form character does not correspond to an architectural or spatial form itself, but instead to that which it represents, or to that which it alludes via the detour of > images, > symbols, or > metaphors. The character of a Gothic net vault, for example, is generated metaphorically through an image of growth and ramification. An explanation of the expressive quality of form characters is furnished by the theory of > empathy. With closer anthropomorphic parallels, broad, heavy forms make an impression – as they do in human figures – of being sedate and awkward, at the same time suggesting solidity. Thin supports, on the other hand, evoke associations with scrawny, elongated human figures, and convey sprightliness and elegance, but also instability. A facade may be interpreted in physiognomic terms as a face, and attributed with a specific expression, whether severe, sad, angry, or startled. In a general sense, one speaks as well of the physiognomy of a landscape. Among other examples, Graf Karlfried von Dürckheim mentions a path that ‘snakes’ through fields, and whose ‘so-to-speak restrained movement’ endows an individual character with expression.

Literature: Arnheim 1977/2009; Seyler 2004

Frame

> depth, door and gate, enfilade, entrance, gaze, image, picturesque, perspective, threshold, view into/out of, window

Free space > courtyard, garden, landscape, square and street, urban design

Function > access, furnishing, readability, type, use

Furnishing

In many cases, the character of a room is dependent less upon its construction than upon the way it is furnished. In contrast to the fixed, built structure, furnishings and accoutrements are flexible components of > situations, which may be subjected to fundamental changes by means of these secondary elements despite their unchanged architecture. One and the same space may be transformed into a cosy living room by means of a three-piece suite, or instead to a workroom through office furniture; a public square is converted by means of market stalls into a market square, or through demarcated parking spaces and barriers into a car park. Through fixtures, a permanent layer, one decisive for its spatial effect and > use, is added to a building in the long term; interior architecture is an aspect of > architecture. In the short term, by contrast, the character of a room can be transformed via mobile elements. Through their combination and positioning, events can be guided as though in an experimental protocol, or directed as though in a stage play. In many instances, the way in which people behave towards one another is expressed through the distances between, alignment of, or grouping of items of furniture that are used in common; communication is affected through their purposeful positioning, progressive adjustment, and changing mutual orientation. The character of architecture as > event steps into the foreground.

By furnishing space, we shape our relationship to the world. The objects that are assembled in a room form a counterpart that receives us when we arrive home; we live together with them as though with a familiar co-occupant, and they may ultimately become an extension of the space of our own body. As reservoirs of > memory which mirror and display traces of individual or collective use, they form a spa-

tial layer into which an occupant's identity is inscribed. Lined with shelves, pictures, niches and fixtures, the walls become introverted projection surfaces for personal life processes. In view of increasing levels of self-reflection and conditioning by means of mirrors, fitness equipment, and media, Peter Sloterdijk (2004) refers to the single person's apartment as a 'self-pairing location'.

As the spatialization of habitualized, automatized behaviour, furnishings become a fixture of everyday ritual. Everything has its place, certain procedures take place again and again in their idiosyncratic forms, and are objectified, shaped and reinforced through individualized furnishings. Despite potential tendencies towards dulled sensibilities or compulsive behaviour, everyday ritual represents a psychically necessary reduction that offers relief from the complexity of the world, i.e. from the demands to respond to constantly new stimuli and adopt a stance towards it (> ritual). Found in the readiness to hand of one's own possessions in a familiar setting is a reliable source of self-assurance.

Every individual activity and furnishing component, e.g. the bed (1), the table (2), the chair (3) and the cabinet (4), as well as the water source (5) and the fireplace or stove (6) corresponds to its differentiated spatial formation.

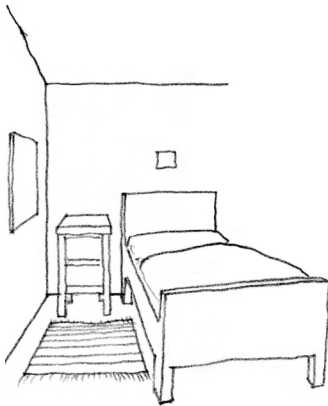

1. The bed embodies a primordial form of everyday living. It can be experienced as an intertwining of intimate spaces. The body is enveloped by protective coverings, by the bedclothes, and by the bedstead. Traditional forms of the bed, including the canopy and alcove types, represent rooms within rooms. The space around them as well, with chair, bedside table and rug, encompasses a further area belonging to the sleeper or convalescent, for example the small private area of a multibed hospital room. The bedroom, finally, is traditionally closed to visitors, while in the > cell, the individual space par excellence, sleep and work coincide.

2. The table belongs to the furnishings of the most public room, just as the bed belongs to the most intimate one;

activity and rest constitute the basic polarities of residence. Traditionally, the dining table is the centre of an apartment. As the focus of > gathering, the table brings a group of people together. The arrangement of individual members of a family or group around the table – whether spontaneously or in accordance with fixed rules – expresses the relationships that exist between them. At both dining and work tables, the tabletop forms a field of attention and serves as the basis for the performance of certain activities. As a doubling of the floor level at a more comfortable height, it allows things to become positioned for attention and arranged accessibly. It promotes a clear overview, allows control, and the generation of order. The format of the tabletop can be conceptualized as a tableau for the arrangement of objects and as a stage for activities involving hands.

3. As a rule, chairs are used in a way that complements tables. The frame of the chair draws boundary lines, and in relation to a table, shows an individual his or her place and spatial zone. To be seated in an armchair is among those > postures through which one's body is contained by furniture; its frame provides stability and a degree of security. Built-in seats at well-favoured places with good views facilitate introversion. On the other hand, the purposeful positioning of a chair or armchair allows strategic positions to be adopted within a room and guides communicative functions. Certain types of seating furniture, for example a sofa with two or multiple seats, influence forms of contact between individuals or suggest mixed forms intermediate between sitting and reclining. In the couch area, various seating options converge to form a close unity composed of sitting room suite, carpet, and a painting on the rear wall surrounded by the glow of a floor lamp (Warnke 1979).

4. Cabinets, shelves, dressers and chests are interiors within interiors. Inside them, the nesting of spaces continues in the form of drawers, caskets and boxes. Depending upon whether the arrangement involves a closed cabinet or glazed

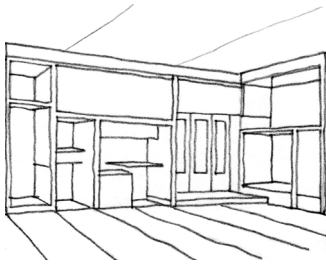

vitrine, an item of furniture either conceals its contents or presents them to view. Open shelves represent an extension of the room within which its volume is extended, now subdivided, or branches off behind panels and doors in the > porosity of finer chambers or still smaller cavities. Through projections of the zone of the body, openings, niches and storage trays at eye or waist level provide interior views or extend the space that lies within reach.

5. The water source is a functional motive for multifarious shaping of sanitary facilities, whether these are restricted to pure hygienic functions or involve the sumptuous staging of the residential bathroom, or even of quasi-sacred bathing temples. Traditionally, the heated bathroom is a place of warmth, of relaxation, which provides the preconditions for undisturbed self-care. A special role is attributed to water: either a shower from above, as though from rain or a waterfall, or a basin where it is collected for use, and finally a large, horizontal body of water in which one becomes submerged. Each of these forms is an occasion for an individualized spatial design of a situation.

6. Both the fireplace and the stove can be traced back to the former hearth. Both are centres of habitation. People sit around the open fire, which forms the focus of conviviality and dominates a situation by drawing the gaze, and by virtue of the sounds, odours and warmth it radiates. With or without an open flame, the cooking place, the stove in the kitchen, also forms a focus. Ever since the fully functionalized 'laboratory kitchen' was supplanted again by the eat-in kitchen, it has come to attract residents and guests alike, and is furnished in such a way that everyone enjoys gathering around the stove. Thus, with the stove, the kitchen becomes the central room of the home. Rarely are all of the senses engaged so fully in experiencing a situation.

Literature: Alexander et al. 1977; Bollnow 1963; Selle 1993

Furniture

> furnishing

Gallery

A corridor or ambulatory that opens up on one side towards a taller space is referred to as a gallery. A passageway or > arcade, veranda or roofed passageway around a courtyard may also be referred to as a gallery; a corridor where works of art are collected and displayed is the source for the term *art gallery*.

The highly characteristic form of spatial experience that is addressed here, however, is offered by a gallery that encompasses an upper > level and, by opening up into a taller space, makes it possible for the visitor to enjoy the extension into height of this space across multiple levels and from an exposed position. This position at half-height makes the gallery an ambiguous location. As an audience gallery in a place of assembly, it offers space for the more remote and subordinate seats; yet as honorary loge it represents a position of prestige. To spend time in the constricted space of the loge would as a rule be unbearable in the absence of an opening towards the larger main space, as Adolf Loos pointed out. The realization that it is possible to conserve space by connecting a tall space with a lower annex was exploited by Loos in his > Raumplan. If the gallery is instead shaped as a balcony or narrow walkway, so that it hovers above the depths, so to speak, then one is confronted with a chasm. But one enjoys good views, and is oneself easily visible. If it is deep enough, one can withdraw into the background and take part in life there indirectly without being visible from the adjacent tall space.

Most galleries have secondary functions or serve purposes of > access. The main hall often encountered in English country houses, for example, is a two-storey space with a gallery that provides access to all the other rooms. This structure, widely disseminated as an entry hall, gathers the entire house around itself. The spatial conception of the gallery with the typical coupling of horizontal and vertical spatial connections

can be varied in any number of ways; its dramatic possibilities are presented in an excessive form in Giovanni Battista Piranesi's *Carceri*.

Le Corbusier made the gallery principle the main feature of his houses of the Citrohan type. This type is based on the articulation of the spatial volume into a two-storey living room together with various ancillary rooms that are distributed across two levels and which to some extent open onto the main space via a gallery. The two-storey portion usually opens up to the street or garden across its entire height. The side (load-bearing) walls remain substantially closed. The result is a contrast between the conspicuously bright double-height room, with its public character, and the stacked, lower, private rooms that are illuminated indirectly by the tall space, but which may also have apertures along the rear. When one stands above in the gallery, the space opens not only up in front of one and across the tall windowed front towards the outside and into the distance, but also below, which is unusual for a residence. In this elevated position, one is exposed, but at the same time enjoys an overview. When one passes from the lower, rear zone below the gallery into the tall space, the abrupt upwards expansion may be associated with a more erect posture, while conversely, the sheltered area below the gallery offers the possibility of withdrawal from the tall space.

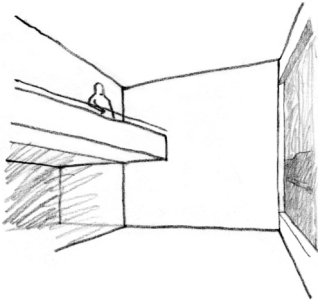

Garden

Gardens and parks are architecture, albeit in contrast to architecture as normally understood, and from urban textures. Wrested from nature, demarcated by clearing, levelled by removing the earth, cultivated by draining wetlands or through irrigation, the garden is the result of acts of domestication. It not only constitutes an architectural space as a fenced-in or walled-in *hortus conclusus*; it must be regarded as architecture by virtue of its deliberate spatial elaboration, which may take the form of the idealized nature of the landscape garden, and of its scenic potential. Gardens in cities, then, are not only

wrested from nature; in them, the artificiality of urban life is confronted by a piece of nature as its antipode. The space of the garden is also defined as an outdoor place in contrast to the interiors of houses. But precisely as a shaped outer space, once again, it counts as a piece of architecture.

This is true as well for landscape gardens, such as the one at Stourhead in England, that are designed to generate images of original bucolic idylls, and where the constant maintenance required to maintain this look of apparent naturalness are not always evident. Dense, dark vegetation contrasts with broad, pictorial panoramas, and the > dramaturgy of spatial > sequences that consist of concealed paths, bodies of water, small garden temples, and astonishing vistas and view axes give visitors the feeling of strolling through a painstakingly composed landscape painting. This is even more the case for the formal garden. Its ground is formed by the levelled earth, and it is subdivided into compartments, fragmented into separate > levels by gentle disjunctions of elevation that are separated and connected by small numbers of steps. Along slopes, gradations into terraced levels are dramatized by grand staircases. The topography of the > landscape forms the basis for modelling the terrain in ways that correspond to the original character of the place.

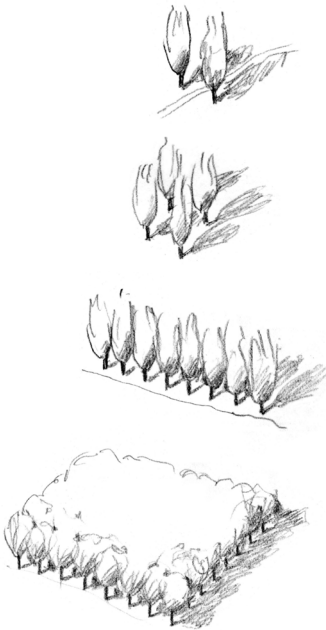

In gardens, it is the vegetation that is primarily responsible for the further shaping of space. An individual tree is capable of concentrating space around it, and of spanning it with its broad canopy. In pairs, trees create gateways, in groups of four, they form the > gestalt of a *carré*. In > rows, trees guide movement, and along an avenue, correspond to a colonnade, or combine with the leaf canopy to form a passageway. At narrow intervals, they are perceived collectively as a wall, although such effects depend upon the species and its treatment, for example pruned lime trees or espaliers. In gardens, the function of walls is assumed by hedges, fences or walls; steps, edgings or streams provide weaker contours. The ha-ha, a longitudinal ditch that is invisible from a distance,

and which delimits a garden from grazing fields, for example, without interfering with views, is a typical resource for the spatial articulation of the landscape garden. Along with pergolas and trellises, the crowns of trees planted in tight grid patterns assume the function of roofs whose dense vegetation closes them off in summertime, while they appear during the winter months as permeable latticework. The trunks of such groves of trees recall hypostyle halls; the orange grove of Mezquita in Córdoba functions as the garden pendant to the columned hall of the adjacent mosque. Buildings and garden architecture are interrelated even more emphatically when the house's outer walls are configured so that they frame the outdoor space, examples being the country houses of Edwin Lutyens with gardens by Gertrude Jekyll. Sheltered places designed for lingering in gardens include roofed, often semi-concealed sitting areas or other small architectural elements such as pavilions, grottoes, or areas contained by hedges. Plantings and hedges that are densified to form almost compact masses have an impact similar to that of architectural elements. In the traditional Chinese garden, the dense interweaving of architectural and natural elements – trellises, walls, verandas, bridges on the one hand, and plants, ponds, rocky masses and hills on the other – are perceived as multiple gradations and superposition of levels ranging from foreground, to middle ground, to background. Emerging through the process of perambulating the intricate paths in conjunction with the contrast of narrowness and expansiveness within a relatively small space is the impression of an involved > layering staggered into unforeseeable spatial > depth (*oku*).

Gardens either cultivate a piece of nature, or transport a piece of nature into the city. In either case, a garden is a piece of culture. With the claim to create a pristine and idealized segment of the natural environment, even the 'wild' garden represents a very special form of cultural experience. Concentrated in the garden is the suggestion of nature within a condensed area, one that is interpretable variously depending

on the garden type, from the kitchen garden intended for self-provisioning, the decorative green space, and the colourful flower garden, to the landscape park, and from the severely formal garden all the way to urban ‘guerrilla gardening’.

Gardens are distinguished by their special atmospheres. The tranquillity of the Paradise Garden corresponds to the contemplative mood of the cloister that surrounds it. The picturesque effect of a landscape garden as an image of ideal, unmolested nature was designed to lend comfort to spirits that suffer from social constraints. Particularly striking among the descriptions of various moods offered by the garden theoretician Christian Cay Laurenz Hirschfeld is the ‘gently melancholic area’, for which a concealed location is decisive, along with deeply down-hanging leaves and generous quantities of shadow, silence and solitude. Also effective in atmospheric terms are certain sounds; Hirschfeld mentions ‘trees in whose crowns hollow noises hover’, and the ‘muted murmuring of water’. The formal garden, based on the far-reaching domination of nature, on the other hand, is conceived in a comparatively rationalist manner. The character of gardens and parks is especially unmistakable when they heighten the special features of the local topography, thereby rendering typical characteristics of the > landscape accessible to experience, for example by shaping pre-existent gradients as terraces, using a rise to highlight a view, or shaping a dell with a brook into a waterfront place.

Literature: Hirschfeld 1779/1990; Rombach 1991

Gate

> door and gate

Gathering

Architecture gathers together. A well-situated, incisive building or central public square gathers together the otherwise arbitrarily distributed structures of a quarter into a coherent ensemble. Through edifices and squares, places are designed

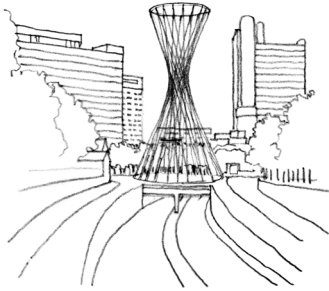

that allow relationships between buildings and spaces to appear graspable. Martin Heidegger (1953/1993) understood the cohesion of river and surrounding landscape when he wrote: ‘The bridge gathers the earth as landscape around the stream.’ In a different way, a dining table gathers together family members or guests as a community around the centre of the home. Using architectural means, the form of the gathering is articulated. Radial streets or entrances represent a > figure of movement of summoning together. A concentric form of spatial containment or furnishing generates a figure of togetherness around the centre, a place of an activity, of an event, of a performance. A large, heavy table that is singled out by the lamp above it as an island of light in a dark room enhances intimacy, while an arena ensures that ‘the people show themselves to their best advantage’ (Goethe 1786/1988).

Other forms of congregation find expression in their respective positionings: when two people come together, they like to sit facing in a corner, and at a long table people prefer to sit facing others. In the figures of his various ‘plans’, which outline forms of the gathering of congregations at religious services, Rudolf Schwarz (1947) has proposed in addition to the centralized layout (‘ring’, ‘chalice’), among others, the ranked and aligned order (‘holy journey’), as well as the receiving, open, hollow form (‘sacred trajectory’).

Literature: Schwarz 1947

Gaze

Among the senses, vision is primary. The gaze seems to grasp spatial reality more completely and more reliably than the other senses. Limited to vision, nonetheless, our perceptions of architecture remain restricted.

While > sound and > odour are always perceived simultaneously from all directions, our visual field is oriented forward, and is restricted to a visual angle of 180°; both eyes in concert are able to encompass a field measuring 110°. In order to receive more than a flattened visual impression of

the space around us, we must move our bodies. A glance, however, is able to take in only segments measuring 25 to 30° with any clarity, by means of which we scan space bit by bit. The consequence of this constraint is, for example, that the > closure of squares or the downward-pressing impact of the ceiling is dependent upon whether the upper edge of the square or wall of the room lies within or outside of the angle of vision. The estimation of the > size of buildings or rooms is conditioned by their surveyability, and hence by the relationship between the angle of vision to our distance from the object. The articulation of the facade of a large building can only be surveyed in its entirety from a sufficient distance, and cannot be adequately grasped close up.

Because of the interdependency of viewing distance and architectural articulation on various levels of scale, a distant view of a building contrasts with a more proximate one. Certain architectural members may seem delicate and elegant from a distance, while appearing massive close up, for example, the pylons of the tent roof of the Olympic Stadium in Munich. From a distance, buildings make the impression of planar images, and landscapes and cities appear as picturesque views (panoramas). Close up, in contrast, the gaze gropes its way along the structure's palpably physical surface relief, even approaching haptic forms of perception, and enriching these impressions via physical grasping, for example of a door handle. In a sense, vision is already able to grasp objects. According to Helmut Plessner, 'The line of sight rushes, so to speak, towards the object, enfolding it like a human hand,' thereby anticipating potential action (1923, 247). In this way, the gaze also anticipates the > extension of our entire > personal space.

Through constriction and framing, > filtering and reflection, the gaze and that which it perceives are truncated, fragmented, or concealed. This dynamic is decelerated by richly informative, so to speak roughened > surfaces and fields of stimuli. Like the other senses, vision tends to produce

simplified interpretations of form complexes. In vision, specific forms are filtered out of the wealth of optical stimuli as > gestalts. In the process of visual perception itself, by the same token, albeit unconsciously, interpretations are produced, for example, the vertical is overemphasized, so that a square wall surface appears taller than it is wide, and a tower taller than it actually is. The movement of the gaze upwards is favoured, so that which is located above acquires greater significance (> monument).

In the domain of architecture, as with all three-dimensional objects, a gaze from a single viewpoint does not yield complete perception, but must be supplemented by a series of views from varied positions; the perceptual image is always composed of multiple partial views. In its results, a mode of vision that is adequate to architecture, i.e. which is produced by > movement (kinaesthesia), is dependent upon the conditions of movement, including tempo, the > dramaturgy of a > sequence, and its idiosyncratic navigation via specific complex actions.

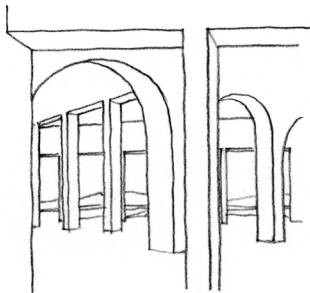
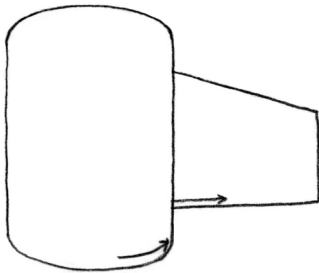

For the most part, directed views coincide with the guiding of movement. We can hear and smell a stimulus from around the corner, but not see it; to do so, we must round the corner and direct our gaze at it. Alongside the guiding form of directional spaces and sucking funnel forms, convex forms allow the gaze to recoil or to be led around obstacles and into previously visually inaccessible areas (> intimation). At times, however, a viewpoint leads into uncertainty, awakening vague expectations or building tension. The repeated and richly contrasting shift from an existing to an emergent image is the basis for a city's lively appearance. In the classical landscape garden as well, changing moods, expectations and illusions are engendered by diverse prospects and astonishing perspectives. Our gaze searches for a stable point at the terminus of the spatial sequence in the form of a visual goal. But it also travels continuously through the space, ceaselessly guided further by view axes and prospects, perhaps delayed by

successively staggered spatial units, or split up by an encounter with an edge, its flow nonetheless maintained by angles, curves and arches. Only seldom is the gaze able to identify the actual spatial order of an architectural structure, for as a rule, we see only partial views in elevation. On the contrary, it is only the plan – which we never catch a glimpse of, but only traverse successively – which reveals the overall interrelationship of spatial complexes and possibilities of movement in space.
Literature: Klopfer 1919; Plessner 1923

Genius loci

> memory, place

Geometry

> concept (architectural), order, perspective, proportion, scale

Gestalt

Because our perceptual powers already structure sensory stimuli into integral entities, a building never appears as a disconnected accumulation of individual forms. This is why the figure of a building, the form of the surrounding space, the spatial structure of a town, the contours of a landscape, or even a movement sequence (> figure of movement) is graspable as a coherent gestalt. In contrast to the term *form*, often used as a synonym of *gestalt*, but actually more general in its significance, gestalt represents a holistic principle according to which the whole is more than the sum of its parts. Our senses necessarily convey perceptual stimuli as ordered gestalts, never as amorphous and diverse stimuli. Already during the process of perception, the parts shape themselves into a totality, one that is set into relief as figure against ground, i.e. it is set off from a larger complex of perceptual stimuli. The unity of spatial perception as well is not simply added subsequently through conscious thought or judgement, but secured via sensory activity itself.

Effective in architecture are many of the rules according to which such acts of integration are experienced – rules that are described by Gestalt psychology as the ‘Laws of Gestalt’.

One example is the wall effect created by a row of columns in a way consistent with the principle that is termed the ‘law of proximity, similarity or continuity’. In some instances, a pair of columns suffices to generate this effect, as at the Piazzetta in Venice. The ‘law of closure’ explains why our perception completes partial spatial demarcations at isolated points as closed spatial figures. It is why the arrangement of four trees into a square, or small facade segments or corners of houses are perceived as a fully defined, squared-off plaza (> closure, > square and street). Conversely, a spatial form is closed only when elements are available that are amenable to perception as a figure, i.e. when a sequence of elements or a corridor is closed by an end wall, visual target, or terminating link, so that it does not appear extensible at will. According to the ‘law of Prägnanz’ and of ‘simple gestalt’, the spatial interpretation of a linear structure as a figure occurs when it is simplified in perception. The ‘law of the inner side’ explains that the > concavity of a form endows a space with gestalt, and a > convexity endows a body with gestalt. In a public square, the two factors may compete. As long as a facade fits itself into the concave contour of the square, it reinforces the spatial figure. When, on the other hand, the convex body of a building becomes recognizable, it tends to project out of the concave contour of the square as a positive figure. According to the ‘law of symmetry’, when symmetrical and asymmetrical shapes alternate within a visual field, the symmetrical ones are more readily endowed with figural properties – a principle that makes > symmetry in architecture a rigorous tool for generating order.

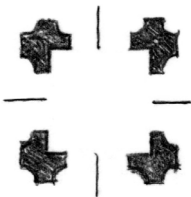

The power with which gestalts assert themselves in relation to a stimulus field allows us to work in architecture with suggestion. The contours of buildings and spatial delimitations need not be fully materialized; in many instances, edges, corners or fragments of surfaces suffice in order to render a constructive configuration recognizable. Even irregularities are rectified via the ordering power of perceptual principles,

so that we clearly perceive right angles, for example, despite minimal deviations.

We become aware of this capacity for accommodating irregularities in perception, for generating simplicity and regularity through sensory activity, as a mode of psychic activity, when we achieve recognition of a gestalt despite deviations by actively ‘working it out’. In contrast, a flawless, perspective gestalt remains lifeless. This active process of working out is often experienced as an advantage.

In German, the verb *gestalten* means ‘to design’ (and the English term is also borrowed in German). But a distinction must be made between gestalt as design and the term *gestalt* as used in Gestalt psychology and related theories of perception. When we recognize that the appearance of a building, spatial structure, or urban texture is not the result of external constraints, but instead follows a purposeful design (or gestalt) intention, we experience this as a special quality (> architecture), as a form of intentionality and valuation. A reciprocal relation between the two terms does exist, however, to the extent that perception of a gestalt is fostered by an incisive architectural design (or *Gestaltung*), one that may in turn rely upon the laws of gestalt psychology.

Literature: Arnheim 1977/2009; Gosztonyi 1976; Seyler 2004

Gesture, spatial

Although architecture is mostly immobile, people habitually read movement into unmoving built structures as their > form character. Through such suggestive effects, certain movements appear as the traits of the forms themselves, so to speak as their forms of behaviour: elongated buildings stretch themselves out, round-bodied buildings seem to expand, some buildings open themselves up, or seem to be oriented towards a particular side, to turn towards other buildings, or to engage in dialogue with them.

We experience such architectural forms as spatial gestures when we feel addressed in relation to our own behav-

our, and find ourselves compelled to a performative response. Architecture can communicate gesturally in ways that are analogous with our understanding of gesture as expressive bodily movement. When we attribute communicative behaviour to an architectural gesture, it follows that a building is capable of eliciting comprehension of that gesture, and possibly an adequate response through our own actions as well. The architectural gesture induces us to follow a dynamic impulse through which a constructive-spatial situation prescribes a movement or recommends a posture. Examples of the impact of architectural gestures are panorama windows, which encourage the gaze to sweep across, rows of supports that lead us along, or the impulse to hold ourselves more erect when stepping from a lower to a higher section of a space. The gestural power of such configurations gains in force the more incisively they are perceived as *gestalts*, and the more they address our various senses and aim towards specific moods. An architectural gesture becomes so determinative that it dominates the articulation and spatial structure of an entire building. In many cases, an autonomous gesture that is foundational for the design as a whole replaces traditional forms of order in architectural Modernism, for example in the form of extended rhythmic sequences or dynamically curved volumes.



Generally speaking, the gesture is suggestive of experiential possibilities that are realized only in the actual imaginative reconstruction and performance of a gesturally oriented form. Often, we do not perceive gestural suggestions of movement in exclusively visual terms, but only once we have performed the movements – whether real or virtual – that seem to have been prescribed by a given spatial situation. The result is an entanglement between perceptions of architectural gesture and our responses to them in such a way that the built *gestalt* of the architecture and the occupants' performative > figures of movement enter into a reciprocal relationship, one that ultimately constitutes the gesture's essence. At

times, however, this may involve suggestions for movement that we cannot possibly perform, but only imagine, one instance being flight. Baroque architecture, for example, is capable of conveying ecstatic agitation down to the smallest detail.

Occasionally, an individual feels addressed by the spatial gesture of a total situation, which he or she addresses in a specific way, not only by imitating the circumscribed gesture through real movements, or by adopting the prescribed posture, but already in following the gesture imaginatively. Herein lies a special quality of architecture, one that prompted the philosopher Ludwig Wittgenstein to compose the sentence: 'Remember the impression one gets from good architecture, that it expresses a thought. It makes one want to respond with a gesture.' (1980, 22)

Literature: Jäkel 2013

- Goal > axis, depth, directionality, gaze, movement, route
- Going > arcade, movement, rhythm (spatial), route, sequence
- Gradation > depth (spatial), enfilade, facade, incorporation, inside and outside, intermediate space, layering, stairs
- Grazing light > ceiling, light, opening
- Grid > order, row, sequence, spatial structure, type

Ground To have 'the ground beneath our feet' is something we experience with our bodies. We rarely question the certainty that the ground will bear our weight, that its unyielding solidity will enable us to remain erect in opposition to the resistance of gravity, to push off from the ground and move forward. That is why there is virtually nothing as disturbing as the instability of the ground during an earthquake, or the loss of firm footing when we sink into a bog. As soon as we stand erect, we must defend our precarious posture against the forces of gravity by engaging in movements that maintain a dynamic

equilibrium, or by enlarging our base of stability by widening our stance.

Our relationship to the ground is ambivalent. Normally, we come into contact with it only by treading upon it; the ground is where refuse accumulates; to go to ground is a form of humiliation; and the dead are buried in the ground. On the other hand, we seek protection by cowering on the ground, we lie down on it to relax, and receive nutrition from beneath the earth.

The progressive historical displacement of the functions of bed, table and hearth from ground level to medium height may be interpreted as the detachment from life on the ground that allows spaces to appear in a different perspective. Nonetheless, the ground is the foundation of our space of activity, and our lives as a whole are played with the ground as a field of action and play and a plane of reference for our primarily horizontally oriented perceptions (> field). When our view is not blocked by some obstacle, the ground – in the form of the horizon – constitutes the unattainable boundary of the range of the human gaze.

In multifarious variations, architecture plays through the ways in which the experience of groundedness can be articulated. By carrying broad loads directly on the ground, it emphasizes the work of carrying loads and its own stability, for example through a pedestal or plinth zone, or attempts instead to escape > weight through lightweight constructions that provide support while coming into contact with the ground at the fewest possible number of points and covering the minimum feasible area.

Through an enclosure, the ground itself becomes recognizable as > territory (as property). But already the dividing line of a delimited surface area, in particular when it is set off by some type of flooring, indicates a boundary between > inside and outside. We realize that you have entered a room as soon as we walk across a defined edge and onto a delimited area of flooring.

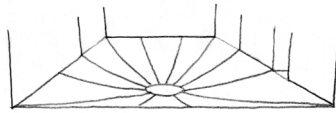
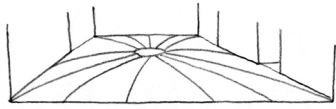

Just as diverse as the modalities of our bodily contact with the ground (just think of the manifold postures such as lying, crouching, walking, hopping, and the diverse contact layers such as socks, shoes and soles) are the architectural possibilities for modifying the ground through floor design. When curved into a convex like the globe, the flooring of a square seems like a taut membrane; when hollowed out into a concave form, it seems to form, together with the walls, part of a cavity. In interior spaces, room height, and consequently spatial zoning, can be governed by means of changing floor levels in conjunction with > ceiling heights. The planar subdivision of the flooring also contributes to such effects. On the pavements of urban areas in particular, our movements are guided by a multiplicity of lines, edges, partitionings and fields that identify routes and places of rest, singling out boundaries and terrains. A special flooring > surface, sensitive or precious material produces a sense of reticence about stepping onto it, influencing movement and endowing the space as a whole with an exclusive feel. The roughness or smoothness of a flooring material influences the quality of our step, as may acoustic phenomena. Our tread may be influenced as well, whether markedly or subtly, through qualities of hardness, elasticity, plasticity (sand) and vibration behaviour, or possibly through an incline.

The interplay of these factors has a strong influence on > atmosphere, whether this takes the form of the noble appeal of an encrusted marble floor on which one steps with a measured tread, or the creaking floorboards of a traditional living room, or carpeting or matting that invite us to remove our shoes and seat ourselves on the floor.

Ground plan

Guidance

> access, residence, spatial structure, structure, use

> directionality, gaze, ingress and exit, movement, plane, route, stairs, wall

Hall

Two features are characteristic of the hall: first, it is the quintessence of the large room, and as a rule possesses a certain breadth; even an extended covered promenade must be more than a simple corridor. And second, it is a room that typically, if not necessarily, forms an independent building, perhaps accompanied by a few ancillary rooms.

Both features together recommend the hall for public, urban functions. In many cases, it has large openings, and in some, no walls at all. The decisive aspect, then, is the roof, which – given its considerable size – must either span a large space, or else rest on supports. In the first instance, the space offers great freedom of movement and flexibility of use. In the second, the supports – often in great numbers – guide movement through the hall in a variety of ways, thereby endowing it with its special > rhythm. In elongated covered promenades such as the stoa of antiquity or the drinking halls of health spas, the mode of movement is oriented – even when entrance is possible from all sides – to striding up and down, and hence to a > figure of movement that is conducive to conversation or contemplation.

Non-public functional halls in particular, including hangars, factory buildings and warehouses, must struggle with the architectural challenges involved in covering enormous, amorphous volumes. Through an optimized relationship between spatial height and ground area or a specific articulation of roof and ceiling, it is possible to avoid allowing a support-free hall to appear as an unstructured, balloon-style container. The large volumes contained by halls, meanwhile, can be exploited in order to make palpable a liberating sense of breadth. Such an impression is dynamized by the wide-span, often cantilevered roof, the rhythmicization effected through vaulting or ceiling panels, and perhaps also by audible reverberations. In a hall resting on > columns or pillars, the number, form and arrangement of the supports give the space structure, while movement is guided by the resultant zones, tracks or naves. Beyond a certain > density, columns and pillars act as obsta-

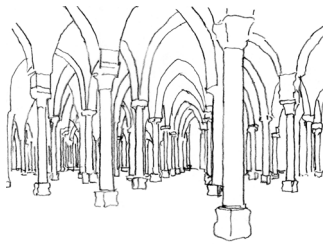

cles that foster a directionless, meandering type of > roaming. Depending upon the distances between units, the hall may be restricted in breadth or perhaps become spatially confusing. Visitors may have the impression of wandering among the trunks of a forest of columns as though in a shadowy grove. If sunlight enters, the open columned hall conveys such an impression by means of the strong contrasts of light and dark created by the shadows cast and by the materialization of > light on the shafts of the columns.

Beginning with the hall of the English country house and continuing with the reception hall, staircase hall, the hotel lobby or theatre foyer, halls have served not just as zones of > access to large houses, but also as places of (public) appearance, to receive prestigious individuals or perform ceremonies. Closed assembly halls such as sports, concert, market or exhibition halls are public spaces that are oriented towards urban space via lobbies and entrance halls. The affinity and transition between the portico as an open columned porch and the open hall of the municipal loggia demonstrates how such halls can be interwoven into outdoor municipal space.

Haptic qualities

Because spatiality is perceived with the entire body, the sense of touch and feel plays an essential role. The sensual impressions acquired through probing > surfaces with our hands is our first contact with our environment. The sense of touch and feel may even be regarded as a primordial condition for perceiving forms visually, for in fact, we actually see only that which we have already grasped, or were able to translate into an analogous experience of physical touch. The haptic sense, then, is perpetually present within visual perception. In contrast to the abstraction of vision, tactile experience involves the concrete. For only that which can be touched is taken up as immediate reality from within the mediated experience of vision, thereby making possible the corporeal location of the subject as a body that is simultaneously touchable and

actively touches a world that is verified as physically real through touch. ‘The human individual articulates the world through the body (...) When ‘I’ perceive the concrete to be something cold and hard, ‘I’ recognize the body as something warm and soft.’ (Ando 1988) For our sense of movement (our kinaesthetic sense) and the experience of space that is based on it, the experience of touch – whether our perceptions of our own movements and situatedness (proprioception) or contact with surfaces – is an indispensable basis. Because of its primordial character, the experience of touch is closely related to the emotions. We say that something ‘touches us’ when it affects us directly and appeals to our feelings.

The physical constitution of touch, in particular through our arms and the specific design of our hands, allows us to experience and internalize objects in accordance with our physical capacities. This encompasses certain patterns of perception and gesture, for example ‘grasping’ and ‘embracing’. By feeling with the hands, a multiplicity of specific characteristics of materials (> materiality) and surfaces are perceived: temperature, humidity, the forms of reliefs, as well as properties such as adhesiveness, slickness, roughness. The movement of objects, vibrations, and even the sound waves of sound and noise can be felt or sensed. In fact, the epidermis is the largest organ of perception.



The principle that we see only that which we can ‘grasp’ is true not only for the tactile sensation of the reliefs of surfaces, but for large three-dimensional forms as well. The bulges and contractions of a Baroque balustrade, for example, invites us to comprehend it in tactile terms. We ‘feel’ smooth, hard, rounded forms or sharp edges when our eyes probe them. Through rough surfaces, our visual experience of space can be ‘roughened’ through details, as the probing gaze so to speak rubs or chafes against them. Similarly, > porosity fosters penetration, thereby provoking a deceleration and intensification of vision. In particular, the way in which the gaze glides across things is intimately related to the prob-

ing touch of the hands. This visual-tactile appeal accounts for a substantial portion of the powers of attraction – but also repulsion – that emanate from forms and substances: such signals amount to invitations to touch an object (or warnings to touch it cautiously) in order to ascertain its character.

Inaccessible elements such as ceiling vaults, for example, can be perceived ‘haptically’ in the sense that the gaze and the corporeal sphere nestles in the rounded curvature above us (> extension). Cold and warm areas such as the draughty areas in front of a window or the warm zone of a fireplace can be probed tactilely as spatially extended zones (> warmth and cold). But containing a strongly haptic component in many cases as well is the measuring out of the space with one’s own steps, and the gauging-tactile sense of one’s own > scale within a spatial situation. Certain architectural elements address this in special ways, inviting us to touch and grasp them: switches, knobs, keys, catches and handrails. The ‘gestalt of grasping’ a knob not only prefigures the act of grasping visually, but also facilitates the incidental and familiar act of grasping without the necessity for pronounced attentiveness. By grasping a latch firmly, pressing down, and sliding the door open, we gain access to the house along tactile lines. When the haptic performance of these actions is not inhibited by the homogenous smoothness of an abstract automatism, the body is able to recall them as gestalt-like figures of movement. They are reinforced by painstakingly designed > details, for example the curving of the handrail at the end of a banister, the winding or projection of steps at the entrance to a staircase, the sculptural differentiation of hardware fittings at > windows and > doors, or the differentiation of sections of flooring. ‘The objects which surround my body reflect its possible action upon them.’ (Bergson 1896/1911, 7)

Literature: Hajek 2009; Pallasmaa 1994, 1996

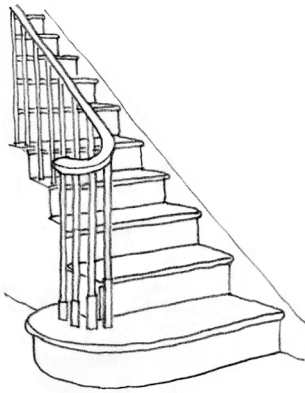

Harmony

> beauty, proportion

Hearing

> sensory perception, sound

Hearth

> furnishing

Heaviness and lightness

According to Georg Friedrich Wilhelm Hegel, the stuff of architecture is ‘matter itself in its immediate externality as a heavy mass subject to mechanical laws’ (1993, 90). The erection of a building is in fact a struggle against the forces of gravity, which becomes vividly perceptible to us in the building design because we must resist the very same forces with our own bodies. But it is not only the Earth that exercises attractive force. Gravitational forces are also effected between individual masses that sit on the Earth’s surface. To be sure, these are not relevant from the perspective of physics, but we do nonetheless experience the forces of attraction and repulsion that emanate from masses.

In perceptual images, they become distinct as forces of intuition, independent > force fields that do not exert force downward like gravity, but instead radiate from each > body in various directions. To some extent, we sense heaviness and immobility in architecture in an immediately physical way, and to some extent, we perceive them visually as > form character (> empathy). Lightness, the counterpart to heaviness, is experienced primarily as the overcoming of heaviness, either as a real property or an expressive quality. In expressive terms, heaviness and lightness condition one another reciprocally.

We know what heaviness is because we feel the weight and inertia of our own bodies, for example when we must overcome its drag in order to climb a flight of stairs; and we are all familiar with the resistance through which heavy masses oppose our own physical actions, for instance when opening a heavy door. Our vertical stance in particular converts resistance against the downward pressure of gravity into an existential experience. As an explicit axis of orientation, this

vertical stance, which defines our position, stabilizes all of our spatial perceptions.

Inclined walls and tilted ground planes generate feelings of insecurity because they call the stability of the upright posture into question; correspondingly, a building renders the heaviness with which it rests on the earth palpable through its tectonic structure in > layerings with an anchoring > base (> tectonics). With increasing distance from the ground, architectural elements seem as a rule lighter, their 'perceptual weight' (Arnheim 1977/2009) is diminished in favour of other gravitational directions, unless the form expresses top-heaviness; we perceive it as wrong for thin supports to carry too much weight, or thick ones too little. Perceptions of gravitational forces also contribute to the establishment of an optical equilibrium between the various forms that make up an architectural structure. But heaviness can be perceived in individual forms as well. Sloping or bulging walls, for example, make a massive form seem especially heavy. Massiveness becomes palpable through the homogeneity of the materials, while a 'monolithic' structure (the literal sense of the word is 'fashioned from a single piece of stone') conceals its contents as a compact, seemingly hermetic object.

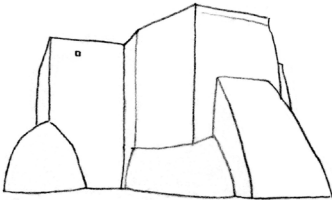

In interiors, we are subject to heaviness directly, to the extent that it influences our own mental states. If a room's boundaries, for example, are formed by an impenetrable, compact physical mass, and supported by a dense, heavy > materiality, then we feel ourselves exposed to pressure from all sides, which generates a sense of constriction. In Romanesque churches, especially in the crypt, this can produce the sensation of a heavy, downward-pressing load. Here, a number of perceptual factors cooperate in order to create a feeling of heaviness, including the course cut of the stones, their solidity and hardness, as well as their horizontal layering. Additional factors are the darkness of the space and its hard acoustics.

The tectonic resources that convey heaviness through the expression of heavy loads on their supports can in principle

be reversed in order to avoid effects of heaviness. Without the stabilizing structure of base, walls and roof, for example, the weight of a house seems to be carried downward into the ground less evidently. A manifest perceptual dynamic in an ascending direction, one analogous to the growth of plants, resists heaviness; in Gothic vaults, loads seem to be deprived of their weight. In contradistinction to the effects of heaviness of loads and supports, constructions under tensile stress seem instead light and dynamic. Walls that are suspended or have no connection with the ground seem weightless or floating, particularly when their material thickness is minimal, and they offer only minimal resistance upon physical contact.

An emphasis on the horizontal effected by means of > flowing space causes verticality of gravitational pull and a building's anchoring by the earth to retreat into the background. Mies van der Rohe's Barcelona Pavilion, for example, seems light, and appears almost about to float away. The structure of architectural forms seems even more detached from gravity when the arrangement is determined by the loose positioning of volumes in a neutral spatial scaffolding rather than being connected to the ground. Now, differentiated gravitational fields seem to supplant the downward pressure of gravitational forces.

Literature: Hanimann 1999; Tschanz 1996; Vogt-Göknil 1951

- Height** > ascent, ceiling, gallery, layering, plane, Raumplan, stairs, tower
- Hesitation** > haptic qualities, incorporation, intermediate space, intimation, joint, threshold
- Hierarchy** > axis, centring, spatial structure
- History** > memory, monument, place, time
- Hollow space** > body (architectural), cell, concavity and convexity, incorporation, porosity, space-body continuum, space-containing wall

Home > dwelling, residence
 Horizon/Horizontalty > body (human), form character, ground, plane, postures
Hortus conclusus > courtyard garden
 House > dwelling, image, theme (architectural)

Idea > concept (architectural), theme (architectural)
 Illumination > light, opening, window

Image An image stands for something that is itself absent. With reference to this customary understanding, two image functions can be identified in architecture: images that are found in or on buildings (1), and buildings that are themselves images (2). If we conceive architecture, however, in terms of > situations, a third conception of the image must be identified in place of the building as image, namely the situation as image. This in turn requires a specifically architectural conception of the image (3).

1. Images on or in buildings may be paintings or sculpture. Paintings on surfaces or the illusionistic treatment of walls or ceilings may contribute to > atmosphere or to the > gesture of spatial situations, or even open up virtual spaces, as in the Baroque era. Whether as integral components of the architectural structure or as additions, they contribute decisively as elements of a synthesis of the arts to our experience of space alongside music and other media of presentation.

2. Regarding buildings as images has been a common practice throughout architectural history. Individual buildings and even entire cities are legible as images: Egyptian temple pylons as a gate to heaven, medieval church buildings with multiple towers as the steepled heavenly Jerusalem, and the bird-shaped TWA airport terminal as a visualization of flight and landing. Image and symbol functions are often mixed together. Particularly characteristic of architecture are structures whose > form character brings to unmediated > expres-

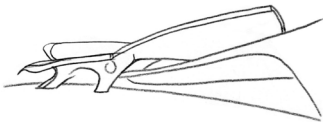

sion that which is presented in mediated form via imagery, for example the dynamic of the ship metaphor in Modernism (> symbol).

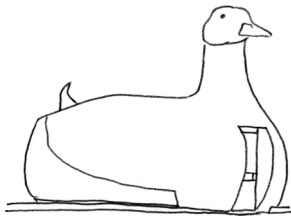

In the context of French revolutionary architecture, buildings were expected to express their functions and characters through pictorial elements and forms. Ever since post-modernism, such ‘speaking architecture’ (French: *architecture parlante*) has been present as the pictorial type of ‘duck,’ i.e. a building that expresses its content through pictorial forms. Robert Venturi and Denise Scott Brown coined the term with reference to a duck-shaped building built by a duck farmer on Long Island in the 1930s who used to sell ducks and duck eggs. To be sure, picturing or depiction are not the principal tasks of architecture, but they do awaken associations with the familiar, i.e. familiar images of past epochs or social milieux. To view a building as an image, however, need not mean that it is seen as a picture. The image character of the building, meaning its emblematic and memorable quality, contributes to the intensity of architectural experience, as in the classical image of the house with slanting, pitched roofs as the quintessence of > dwelling.

In the framed prospect, by contrast, i.e. as seen through a camera viewfinder or on a monitor, architecture becomes image in the sense of its isolation via framing and the fixing of a view from a static standpoint. It is not experienced through action and movement as a concrete situation; instead, the pictorial composition, contained in a frame, establishes distance, transforming architecture into an object of contemplation. In many cases, tourists experience real places only from the perspective of the beholder of images. The > picturesque image of architecture, seen principally from its photogenic side as a facade, is based on planar proportions and relationships of scale, attractive coloration and surface effects, interesting superimpositions of form, the play of surface and depth, and often on bold and striking symbolism. It is perceived almost exclusively in visual terms, and is well-adapted to contempla-

tive viewing. But it also offers the advantage of being amenable to substantial control, and is easily reproduced and globally disseminated; as an incisive and readable image, it is also well suited to marketing purposes. In all these cases, the image content tends towards a certain artificiality, one that is detached from a given situation and does not belong wholly to the beholder's reality.

3. This mode of image perception, however, may be displaced by a specifically architectural experience of the image, one liberated now from fixation by any single viewpoint. Summoned to life as soon as architectural space draws us into depth and surrounds us, or else generates a three-dimensional field of tension via corporeal confrontation, is an authentically 'architectural image'. Although the visual qualities associated with the previous mode of perception may still play a marginal role, the situation as a whole now becomes an image. It is no longer a question of purely optical contemplation; instead, the image extends around us, we are contained by it, and we perceive ourselves within it. Although this architectural image neither represents any external reality, nor presents us with picturesque contents, like other images, it can nonetheless be regarded as a true image: the way in which real spatial situations, including actors, can represent something is familiar from the theatre. There, every scene summons a suggestive image, and is the staging of something in the sense that it not only depicts a fictive set of events, but also shifts them into a particular light, thereby generating an imaginative image magic. Its medium is not the stage setting alone, but also the situative interplay of spatial design, atmosphere and action, in ways comparable to architecture. The equally vivid resources of spatial design, atmosphere, and the movements and actions of figures also produce a scenic image, albeit without a play. We, the beholders, are found within this architectural image. The architectural image also engenders an imaginative image magic, not to stage a fictive reality, but for the sake of reality itself. In fact, one often feels as

though one had been inserted into an image by the architecture. Corresponding to the pictorial act, through which the observer delimits a stable image field from the diffuse flow of perceptions, is the fundamental architectural function of contouring a situation spatially, of screening off inner from outside in the broadest sense in a way analogous to a picture frame. Through its performative character, moreover, such an image of a city or architectural structure itself becomes a > scene.

This conception of the architectural image has various consequences: spatial situations can be structured in such a way by architecture that they attain the power to mould images, so that we are emboldened to create an 'image' from them, which is to say: to grasp the total situative context accurately by going beyond the isolated standpoint, which is itself in turn embraced in its changing state by the context. That to which the image alludes does not lie outside of architectural reality, but reflects it through self-referential attention. If this is the intention of the architectural design, even the everyday reality of the city and of the architecture acquires an iridescent significance, an aura of the remarkable, through this image status. Within this image perspective, and by exiting a purely functional attitude towards our surroundings, we experience our actions as remarkable. Objects appear strange, our interest is heightened, we are suddenly able to experience things that previously seemed insignificant. Our perception is now unconstrained by rules, by a fixation on the purely instrumental; through dispersed attentiveness, it can now allow itself to be seized by the richness of the whole, and even by its > beauty.

Immersion
Immovable property
In-between

> dwelling, experience, interior, residence, virtuality
> movement, time
> intermediate space

Incorporation

By nesting spaces inside one another by means of incorporation, fundamental operations of containment and the penetration of containment are multiplied. Literally, to incorporate means 'to swallow up'. Transferred to buildings, the concept means that a building or building component is contained within the body of another, is 'incorporated' by it. With regard to the spaces involved, it is a question of a telescoping or nesting operation. Incorporation occurs on all scales, from that of the cell to that of the city as a whole. In principle, every object that encloses space can be perceived from the outside as a body, and from the inside, in contrast, as a cavity or aggregate of cavities. A simple, closed spatial container, on the other hand, cannot be perceived simultaneously from the inside as a cavity and from the outside as a body, since we stand either inside or outside. Things are different, however, with the 'house within a house', where multiple space-enclosing bodies are contained (incorporated) by one another: in the simplest case of incorporation by one body in another, it is already possible to adopt a position in the > intermediate space between these bodies and the surrounding shell. I find myself inside in relationship to the outer body, and outside in relationship to the inner body, I perceive the outer one as a cavity, and the inner one as a body. This ambivalent perception of > inside and outside, as well of body and space, is essential for incorporation.

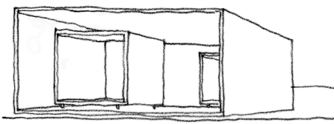

At times, we encounter more than one additional body inside of a spatial shell. A town enclosed by a wall, or a fenced-in farmstead, for example (both perceived from the outside as close bodies), confront us in their interior with a number of buildings alongside one another. These may in turn contain further bodies that nest inside one another. That constructions are arranged simultaneously alongside and within one another is characteristic in particular for urban structures, and represents a specifically urban form of the > space-body continuum. The space between architectural bodies within which we move may be regarded as an inter-

mediate space in a double sense. We find ourselves, on the one hand, in the space between architectural bodies that lie alongside one another, that is to say outside of them, while on the other, between bodies and a containing shell, between core and sheath. Perceptual ambivalence oscillates between these two types of spatial impression. In moving through a town, for example, the dominant impact changes according to location.

More decisive for incorporation than juxtaposition is the nesting of space-containing bodies. The relationship of nesting has the potential to be extended definitely, so that every body contains a further body, and every shell is contained by another one. Standing in the foreground depending upon the direction of the gaze and of movement (from the outside in or vice versa) is either a stepwise, delayed penetration, or instead the conception of stratified, graduated containment. The act of entrance is repeated in one directional movement from layer to layer. Theoretically, we can never be sure how many steps are to follow. Oswald Mathias Ungers (1983), who has characterized the phenomenon of incorporation as a fundamental architectural > theme, speaks of the 'potential endlessness' of a 'procedure that is no longer logically graspable'. For the progression from inside out, conversely, incorporation can best be characterized as the intention to surround the core with multiply layered shells, for protection, for concealment, for expansion, to increase the available space, to externalize certain activities, or to create distance and room for manoeuvre (> interior). Examples are towns or castles that are protected by multiple rings of walls and fortifications, apartment buildings that hide behind garden walls, fences and hedges, buildings with external spatial layers for additional uses, i.e. for circulation or as climatic buffers. For those who find themselves in the interior, the world outside is held at a distance by the outer spatial layers. At the same time, they block direct access to the outside world, making it possible only via intermediate steps.

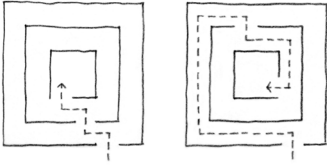

By means of staggered spatial layers that are perceptible as > thresholds, it is possible to generate tension in ways that heighten meaning. While the path is clearly prescribed when the threshold lies along an axis towards the centre, it may become unpredictable or even labyrinthine when openings are offset. In such cases, one may find the threshold leading to the next spatial layer only after partially circumambulating the incorporated body. The circling of the centre in a cautious approach represents a strategy for retarding movement en route between outside and inside.

Literature: Ungers 1983

Individual area

> accessibility and exclusivity, cell, furnishing, spatial structure, territory, residence

Ingress and exit

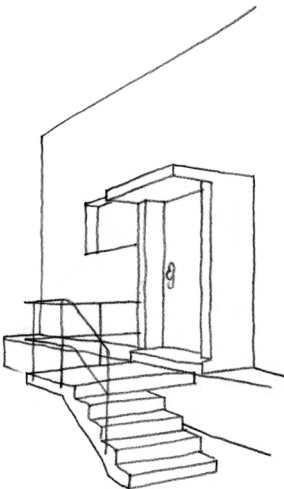

You only know ‘that you are dealing with architecture when it is possible to enter and exit it, and when this possibility of entering-and-then-exiting is capable of altering circumstances,’ claims the systems theoretician Dirk Baecker (1990, 83). To enter and to exit are among the fundamental operations of interplay between > inside and outside, separation and connection (> screening). In contradistinction to > views into and out of a building, and to other > openings that serve a rather secured and guarded relationship to the outside, ingress and exit are active operations, with all of the associated consequences of surprise and risk.

Like such operations, ingress and exit are characterized not only by the overcoming of a boundary, but also by the ambivalence and contradictory character of these two directions: inside, and back outside once again. They are implicated with a far-reaching symbolism of often existential significance.

Ingress and exit are actions for which the same architectural element is generally intended, namely the > door – an element that functions simultaneously as entrance and exit.

They are not only contraries, but also complementary in relation to one another. In order to enter, one must be outside; conversely, one must have entered in order to leave. The generally conflictive nature of such movement, with its double directionality, is represented by the two-faced Roman god Janus, who was not only regarded as the god of entrances and exits, but also of beginnings and ends, arrivals and departures, past and future. In architecture, ingress and exit as transitions between inside and outside are simultaneously passages between surroundings that contrast with one another in terms of noise, warmth, lighting, dimensions and materiality, as well as regarding divergent levels of > accessibility. Openings enjoin us to pass between these environments, but also signal limitations to these operations through physical constrictions or by virtue of the fact that the threshold can be secured. With regard to structural appearances as well, entrance and exit show a double face. Upon entering the building, we perceive the entrance as a key element in relation to the facade as a whole, while this is not the case from the inside. An exit lacks the significance of an entrance. In emphatically open structures, however, the tension inherent in this passage between zones is virtually dissolved, for example in Mies van der Rohe's Barcelona Pavilion. Individual wall slabs only hint at the separation of inside from outside, and upon entering, we already find ourselves exiting again.

As we enter a building, it is already capable of conveying a foretaste of the character of the > inside; it may either attract or intimidate. Certain architectural elements and processes are especially characteristic of an entrance. In medieval church portals, for example, the funnel form functions as a guiding element for those who enter, and announces the procession route that continues inside, while in commercial architecture it pulls customers into shop interiors through subliminal compulsion. The columned portico is primarily a widely visible receptive gesture for those entering, but at the same time it signals a building's dignity and status. By moni-

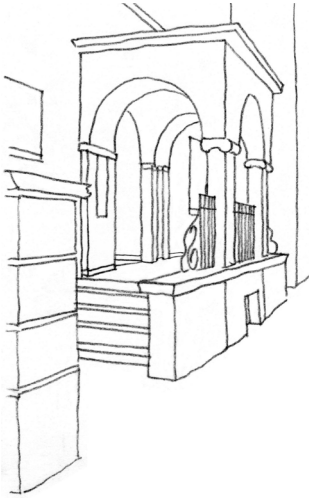

toring admission through instruments such as doorbells, intercoms, spy holes, or the presence of a doorman, the entrance becomes a controlled > filter. An initial ingress is followed by subsequent steps of entry; one looks around, greets others and is received, for which purposes > intermediate spaces and > thresholds must be formed as spatial stages. Outer clothing may be removed, the grime of the street cleaned off. These processes are either informal, or else executed as > rituals in ceremonial fashion, and call for corresponding amenities such as cloakrooms, doormats or washing facilities.

To leave a building means to surrender the security of a sheltered interior, or to liberate oneself from its constriction. One hesitates on the threshold, perhaps in order to assess weather conditions. French windows and balconies provide tentative yet still protected forms of emergence into the outdoors. Other architectural elements such as a pedestal set before the front door, or a pulpit-style projection, offer an overview. *Literature: Alexander et al. 1977; Baecker 1990; Mäckler et al. 2008*

Inside and outside

Inside and outside are the alpha and omega of architecture. To organize their relationship and to render their interconnection experienceable in concrete terms through design is a genuine task for architecture. Interior and exterior forms always condition one another reciprocally, and a range of types of relationship between them are possible, beginning with a correspondence (> readability) between inside and outside with only subtle deviations, all the way to dramatic opposition. In one case, the > inside is represented externally. In the other, an entirely sober exterior may contain a refined, complex, multifaceted interior. In the words of Adolf Loos: 'The house should remain silent outwardly, revealing all of its richness only within.' Nevertheless, a building whose exterior makes the impression of keeping silent about something is not simply mute; it shows that it has something to hide. This very

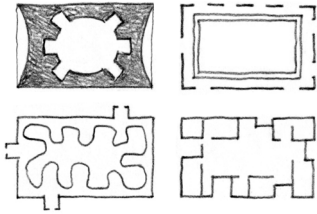

ambivalence between concealment and revelation generates a special tension between inside and outside. Various types of transition express the influence of exterior on interior and vice versa. Robert Venturi (1966), for example, has cited variants of a double shell, the first of which follows interior conditions, the second external ones. The outer shell itself, in turn, may be given a concave shape, thereby delimiting an inside within external space (> concavity). Fundamentally, gradations between inside and outside are possible through which the exteriors of various buildings are combined to form an external interior space, for example a public square, while conversely, an exterior space may be carved from the interior of a building, i.e. > courtyard. Gradations from interior to exterior can be extended in both directions by means of > inversion and > incorporation.

In detail, architecture organizes the relationship between inside and outside not only by furnishing buildings with > screenings of contrasting character with various > openings for > ingress and exit or > views into and out of buildings, but also through detailed elaboration of > thresholds, > filters and > intermediate spaces with the objective of establishing differentiated > accessibility. Articulated by means of gradually modulated illumination, > materiality and atmosphere are nuanced transitions (> introduction). Interior and external character may be superimposed in such a way that inner and outer are experienced in relative terms. The multifarious ways through which interior-exterior relationships can be shaped in architecture is reflected in the characterizations of many other architectural concepts.

In a highly general sense, the interior stands for privacy, possession and in-gathering, the exterior for the public sphere, availability and dispersal. Whereas the contrast between security and intimacy within and sense of lostness, foreignness or danger without is at times experienced in ambivalent ways. To be bounded within an interior can be experienced as constriction or confinement in contrast with the liberating ex-

pause and freedom of the outside. The development of the individual requires both a delimited space and the possibility of outward expansion. The relationship between inner and outer, finally, bears countless additional implications of everyday and existential relevance, and harbours numerous metaphors, beginning with the distinction between self and world, all the way to the distinction between what is currently 'in' or 'out'.

Literature: Baecker 1990; Van der Laan 1983; Venturi 1966, Waldenfels 1990

Intellectual pleasure

> concept (architectural), measure, order, proportion, readability, theme (architectural)

Interconnectedness

> access, axis, context, square and street, structure, urban design

Interior

Inside begins with the shadow of a tree, and extends all the way to the constriction of a cell. In its most sparing form, the interior is only implied, for example by a cloud of steam, a cone of light, a zone of sound, or when, in close proximity to a building, one enters its > space shadow. When one steps onto a specially treated floor surface, into the protected zone formed by the angle of two walls, or beneath a roof, one already has an impression of an interior, of being protected from the elements, provided with dryness and warmth. The feeling of being indoors ranges from the merest suggestion formed by a minimum of constructive elements, and all the way to the extreme of a space that is 'turned inward onto itself', that is to say, a fully introverted room. This character of being 'withdrawn into itself' results first of all from structural traits, for example through extensive > closure, through the containing contour of a > cavity, or through > centring, that is to say, an orientation towards the innermost spatial core. Decisive secondly are the elements of furnishings and materi-

als, through which the architecture ‘turns towards’ the interior and its occupants.

When the fineness of the facing of the spatial envelope offers itself to the gaze and the touch, it corresponds to the lining of an article of clothing (> covering). In addition, the interior walls serve as projection surfaces, mirroring forms of individual > use, registering their traces and rendering them readable. Through the interior architecture of niches, built-in seats and alcoves, interior surfaces become > space-containing walls that are turned inward. Through individual adaptations, finally, the interior can be tailor-made to fit the individual almost like a custom-made case. A multiplication of such inwardness is formed by the separate chambers of secret and hiding places, of *chambres séparées* and burrows for children. Spatial densification arrives finally at the individual > cell or the bed. A concentration of the interior on a focal point, whether fireplace or stove (tellingly, the Latin word *focus* means fireplace or hearth), or for example by means of the centring effect of a zone of lamplight, promotes > gathering around the centre.

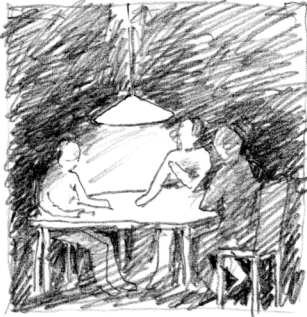

Through the ambivalence of security and cosiness on the one hand and confinement and solitude on the other, introversion can become a delicate experience. In the *intérieur*, which only mirrors one’s own experience, one remains alone, trapped in one’s own biography. As a custom-made case, the interior becomes an impression of unchanging personal traces, as characterized by Walter Benjamin (1933/1999, 542): ‘The etui-man looks for comfort, and the case is its quintessence. The inside of the case is the velvet-lined trace that he has imprinted on the world.’ To the *intérieur* as an image of interiority, Benjamin offers the image of a space composed of hard, smooth materials, ‘to which nothing adheres,’ and which makes it possible to begin anew repeatedly.

The sheltering and in-gathering value of > dwelling in an interior rests on the complementarity of the outside and the activity of the occupant there. Oftentimes, however, we

experience interior spaces as cavities that have no exteriors. Only the inner sides of the walls of one's own apartment are perceived, as though the dwelling were a cave that was enterable only through the front door. The interior becomes autonomous as a detached, independent world. That which lies outside of its walls seems unattainable, almost non-existent – although we may live a mere 20 cm away from a neighbour. A counterpart to such exclusively interior reality would be an architecture that turned the outside inward in ways comparable to a reversible coat, so that through > inversion, an introversion of the exterior occurs, an example being the building type known as an arcade.

Literature: Bollnow 1963

Interior architecture

> furnishing, interior

Interior courtyard

> courtyard

Intermediate space

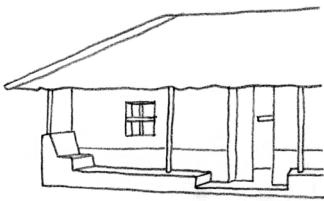

The 'in between' that occupies the transition from one room to the next, yet which belongs to neither, or to both simultaneously, is an elementary phenomenon in architecture. It appears in numerous variants. Intermediate spaces emerge in particular where the > threshold is expanded from a boundary line to a threshold space, not only between > inside and outside, but also along transitions between various interior spaces. Every space-containing > facade with niches, embrasures, bay windows, or other 'spatial pockets' represent a space that is intermediate between building and town. Individual structural elements, including the > arcade, > gallery, loggia, veranda, terrace and balcony, form special types of intermediate spaces. The roof terrace may be regarded as an intermediate space that forms a transition between building and sky; likewise, the basement can be interpreted as a transition to the earth. Created by means of > inversion are 'interior' intermediate spaces such as the courtyard, the *rue*

intérieur that leads through a building, or the shopping arcade. Within the extreme density of cities like Tokyo, for example, the gaps present within the urban development are used as living space, and moreover without distinguishing between public and private outdoor spaces.

The phenomenon of intermediate space demonstrates that the characteristics of > inside and outside, > body and space, > closure and openness, private and public, need not represent irreconcilable polarities, but that the one can be achieved with the assistance of its counterpart through ‘reciprocity’ (Van Eyck 1960/2003).

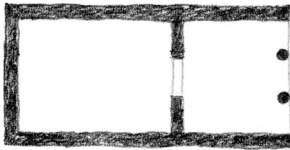
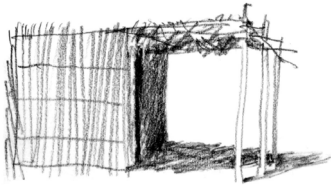

Among intermediate spaces are the vestibules that delay a passage or break it up into steps. A passage, however, may terminate in an intermediate space, such as a bay window or summer room. When stepping into a bay window, one has the feeling of withdrawing from the room, of being outside in a certain sense. Seen from outside, in turn, loggias, terraces, verandas and balconies are stages of a sort in public space, where the lives of occupants are observable. In an analogous way, the sheltered spaces of arcades and pergolas, which are set part-way within buildings, are available for typically public activities.

The character of intermediate spaces emerges already through the superimposition or mixture of traits, for example temperature, acoustics, or illumination, which originate in adjacent rooms. Surfaces and materials that are allocated to one side continue into the next, and elements typical of one space serve in the other as well. Patterns of behaviour are mixed and transformed.

Constructive resources encompass the staggering or > layering of wall planes in depth, folding, inside-out inversions of the spatial envelope and vice versa, as well as gradations in degrees of > screening or permeability. Special constellations are, first, the superimposition of the plans of two adjacent spatial spheres, whose intermediate space is formed by their intersection (> transparency), and second, modelling as thick

> space-containing walls which not only effect the overlapping of inside and outside, but also of body and space. Transitions through thick walls, which themselves contain cavities, niches and storage compartments often form passages having their own sizable intermediate or connecting spaces. And when they are traversed, a shift is clearly noticeable.

As a 'lock', an intermediate space has the character of a third, enclosed unit that mediates between contrasting conditions in two adjacent rooms. The elevator cabin, on the other hand, is a movable type of intermediate space with quite independent spatial properties; within it, one is briefly left entirely to oneself, or else exposed to a state of extreme social densification, albeit one that is dissolved almost immediately.

Acts of > ingress and exit in particular are articulated by means of sequences of intermediate spaces, which prevent one from 'barging' directly through the door and into the building: in approaching a house, for example, the act of entry is contained by a segment of external space through a change of direction and 'collected' in front of the building, perhaps in conjunction with the sweeping gesture of an accompanying wall. Forecourts, front yards, and front gardens, sometimes separated by fences or garden gates, provide initial stopping off places. Through a spatial extension that is set before the building, a portion of the interior space is shifted outward. Porches, canopies and arcades, in turn, form spatial layers that still lie outside, yet whose projecting roofs provide shelter from rain, and through sparing lateral containments, wind as well. If the front building is set on a pedestal, it offers protection from the dangers of the street. One enters the house when still outside, so to speak, one has already arrived, and perhaps takes a seat on a bench. When leaving the building, this pulpit offers an outward and overview, facilitating orientation. The building – or individual apartment – is already entered when we step onto the doormat. This not only serves to clean shoes and to separate a sanitary from a dirty sphere; on it, the arrival already steps onto a piece of interior flooring.

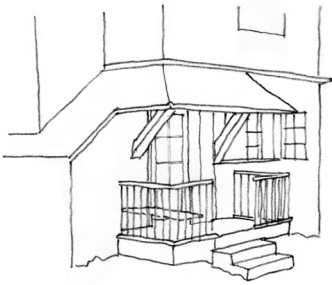

The doorway itself already forms its own intermediate space – not only as a revolving door or with a draught lobby, but already through its reveals. This volume, which varies according to depth, can be extended in depth perspectively through the funnel-shaped intrados of a portal.

A classical intermediate space is the foyer, vestibule or entrance hall. It is an interior space, but at the same time, one finds oneself still in a front area, beyond which not all arrivals are allowed to proceed, for here at the latest, the decision is made to admit or refuse. With more elaborate versions of the entrance hall, one is detained by a doorman, and individuals assemble; one may have to wait until further progress is permitted, or one is fetched. Here, the goal-oriented form of movement found outside is allowed to reverse itself, adopting a more tranquil attitude that corresponds to activity within. The intermediate space is also a place for the > ritual of greeting or parting, and in special cases, for a corresponding ceremony. One is relieved of the warmth of one's coat, since its function as a shell for the body is now taken over by the spatial envelope of the building. Here, we can orient ourselves in relation to the remainder of the building, at least to the extent that its > spatial structure allows an overview, that the spatial > order is perceptible from this point. The architecture exercises an influence on the role of the vestibule as a space of anxiety and trepidation, excited expectation, or hopeful promise.

We also know that in many instances, anterooms and intermediate spaces are the settings for tasks that are more important than those assigned to the main spaces themselves. Decisive social contacts and consequential encounters often take place here. Important decisions are often made in transitional spaces. The foyers of museums, theatres, and hotel lobbies are places of social encounter; the corridors and lounges of universities are places of productive exchange. The political significance of anterooms and intermediate spaces is exemplified by the ceremonial function of the representative

> staircase, but also by the political influence through the proverbial power of the lobbyists.

Architecture assumes the task of articulating the in-between in spatial terms, of shaping places and spaces of transition in a differentiated way. We continually move through transitional spaces or linger there, in entrance areas, in threshold and intermediate spaces. In fundamental ways, architecture is an art of intermediate spaces.

Literature: Alexander et al. 1977; Nitschke 1989; Stalder 2009; Waldenfels 1990

Intimacy

> accessibility and exclusivity, furnishing, interior, light, personal space, view into/out of

Intimation

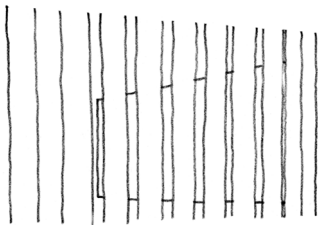
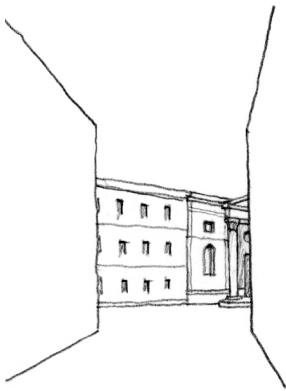

A spatial intimation calls attention to locations in a space that are initially out of range, but which can as a rule be attained in the course of movement through a space.

Views through, as well as > views into or views out of a space, and perhaps acoustic intimations as well, guide our attention towards something that is concealed behind a wall or around a corner. Or an > interior becomes visible through gaps in a > screening element, whose material permeability allows structures situated behind it to be surmised. A barrier that blocks our view, one whose placement at the same time indicates the direction of its overcoming, for example a front viewed obliquely, or the convex form of a building's curved wall, which guides the gaze around it and towards the rear, are variants of this simultaneous play of deceleration and of anticipation. At times, that which is intimated remains entirely concealed from view. The indication of a continuation at the end of a path, of something present around the corner, or the way in which a light at the end of a dark alley awakens indefinite expectations; all of these makes us curious, while in extreme cases leaving everything in a state of uncertainty.

Introduction

Architecture has well-developed means at its disposal for organizing the act of entrance in such a way that we do not simply barge into a building without preparation. These means are used to lead us into a building or architectural complex through multiple steps that prepare us for what can be expected inside. This spatial introduction is effected by means of a gradual process of attunement, > intimation, and partial anticipation of that which awaits us, or tension is built through contrasts of room size, lighting, or atmosphere, or through changes in gradient or direction that heighten arrival through the unexpected.

Adolf Loos referred to such strategies, which he often deployed in his designs, as forms of 'introduction' (Kulka 1931, 36f), by which he meant a > sequence of spatial elements and segments, a succession of perceptions through which one is meant to be 'slowly prepared and nonetheless surprised', whose > dramaturgy allows the contents of the building, the goal of a sequence, to seem remarkable, or to appear in a certain light. This introduction may be composed of a series of phases or segments, each of which arouses new expectations in relation to the whole, and each of which is either confirmed by its successor or enhanced in effect via contrast. Step by step, the total effect approaches the impression that arrivals are intended to receive.

Literature: Kulka 1931

Introversion

> angle and corner, centring, furnishing, interior, postures, residence, roof, space-containing wall

Intuitive form, intuitive force

> body (architectural), density (spatial), field, force field, heaviness and lightness, sensory perception

Inversion

Through spatial inversion, the outside is turned into the inside, and vice versa. To be sure, every inner courtyard is a form of inversion. Strictly speaking, however, a literal inver-

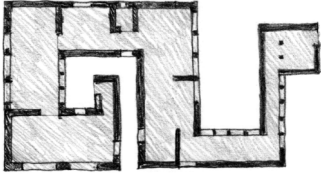

sion shifts the accessible exterior space into the interior of the building in a continuous way, so that it becomes possible, for example, to exit the building from its centre without crossing additional thresholds, to step outside without transition. Through inside-outside inversion in turn, individual interior rooms are shifted out of the building entirely; they are still connected to its interior, but are at the same time entirely surrounded by external space. Through repetition, inversion makes possible the finely divided interfolding of > inside and outside, so that at many places, the interior is in close contact with the outside, and the building with its inside rooms, conversely, is multiply entwined with the space outside (> folding). Inversions in both directions (inside to outside and vice versa) result in opportunities at many points for an unmediated passage between inside and outside. Locations and activities can be integrated and organized into a detailed composition of these two components.

The results of inversion in a more general sense are external spaces that are experienced as being closed and introverted, i.e. they are experienced as interiors, as are spaces with an external character that are located inside. Multiple inversions emerge when, for example, a building annex is externalized onto a > public square or > courtyard via inversion, the latter being itself inverted in turn inward into a city block. The relationship is not always explicit, for that which is experienced as an inside space from one perspective appears from another as an outside space (> incorporation). Essentially, inversions on various scales occur in every dense urban development; to some extent, the > space-body continuum of urban space-formation is based on them: 'The inside space of the outside space is the outside space of the inside space' (Loderer 1987).

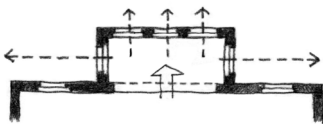

On a smaller scale, bay windows or other sculpturally formed windows that project forward from a facade also qualify as inversions. These illustrate how a constructive-spatial inversion can be associated with a peculiar inversion of psychological states. In a corner or bay window, for exam-

ple, one is not only enveloped by external light from multiple sides; one's private affairs are also 'exhibited', displayed to view from various directions. From an entry pavilion that is thrust outward like an extension, arrivals are courteously gathered together, fetched, and guided into the building. A retracted front court helps visitors to overcome fears of crossing the threshold. As an external space, and although it actually lies inside, it acts as a delaying intermediate step that proceeds the ultimate entrance into the building. In such instances, inversion produces > intermediate spaces.

The interweaving of interior and exterior has been referred to by Aldo van Eyck as 'reciprocity'. In a way analogous to Leon Battista Alberti's celebrated comparison, his orphanage in Amsterdam was meant to be 'a city like a house, a house like a city'. (1960/2003, 38) As accesses, some interior spaces are given a street character, their lighting designed to approximate street illumination. Patios were designed to resemble urban squares, their outside character – in contrast to the white inner walls of the group rooms – displayed through dark, rough wall surfaces. The early Christian basilica – with its colonnades and gateways – was already legible as a Roman urban street that had been inverted inward.

A reversal of character from outer to inner may occur in the opposite direction, when for example the inner space of a rotunda becomes an outer space, as in James Stirling's Staatsgalerie in Stuttgart. The building type of the shopping mall, in turn, was characterized by Walter Benjamin (1982/2002) as resembling a street that had become an *intérieur*, an 'apartment of the collective'. But 'arcades are houses or corridors that have no exteriors – like dreams'. Just as the 'ambiguity of the arcade is ambiguity of space', spatial inversion is characterized by an ambiguity of the relationship between > inside and outside, one that can lead to the confusion of equivocal perception, so that one may come to doubt whether one is inside looking out, or the other way around.

Literature: Van Eyck 1960/2003

Invitation character

Normally, we move unselfconsciously through an architectural structure. Without conscious thought, we generally know which positions we wish (or are compelled to) assume and where, and the locations of options for lingering, changing levels, or finding views.

We have developed schemata that are adapted to a variety of situations, making it possible for us to orient ourselves quickly. To a decisive degree, however, they also are shaped by the appellative traits of objects and situations, which are referred to as their invitation character or offer character. Without additional explanation, architecture is quite capable of conveying to us the specific offerings it wants to make.

Solely by virtue of its typical forms and dimensions, a chair, for example, invites us to take a seat by positioning our limbs accordingly – and the same is true although in different postures when the object in question is an armchair, a bench, or even the base of a wall. This offer is extended further by > context, for example, by the presence of the table upon which the chair invites us to engage in a specific activity.

Less suggestive, but nonetheless appellative in character, is the experience of the situation in which, for example, a 'greeting balcony' adjacent to a staircase invites us to enter it, and to contemplate a partial sequence of the approach from a different perspective. In such an instance, the architecture makes an attractive offer, one that significantly enriches and deepens our spatial experience without compelling us to accept it. Invitations and offers are rendered more precise through the expressive qualities of a specific > gesture, for example the form of a corridor that invites us to enter, while modulating this entrance via the conditions of approach, the form of the opening, the frame, the flooring (which invites us to step onto it), the depth of the passage, all the way down to specific details. The application of smooth tiles to a narrow, even constricting passageway, for example, may invite the user to traverse it in a frictionless and gliding way, thereby conveying an impression that contradicts its actual character,

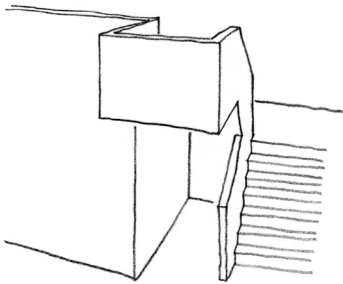

whereas the use of coarse, rusticated masonry would have a very different effect.

Such proposals for experience and use on the part of an architectural structure can have highly divergent degrees of incisiveness, attractiveness or urgency. If these invitations guide us towards highly specific movements in an exceedingly suggestive fashion, we may be dealing with a borderline case that comes close to a situation of compulsion within which the user is not invited, but almost forced to behave in a certain way, even if he or she is unable to understand its purport.

Joining

> composition, detail, spatial structure, structure

Joint

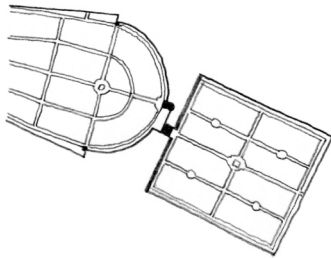

A joint establishes a moving connection between two or more members. Parts of buildings and of rooms or public squares can be connected by means of joints. While not moving themselves, persons establish and perceive the character of a joint through their movements. Such a connection is experienced as movable when the formal linkage and spatial connections found at the site of connection are not constant, but are initially disturbed or interrupted and then re-established in an altered fashion by architectural means. The transition is articulated in a jointed manner through the addition of a link (Latin: *articulus*, small joint, member), which may be a spatial or corporeal element. A quite simple joint is formed already by a > door together with the space of the > threshold. For the most part, a joint involves a change of direction or spatial division, or is formed as its own jointed space, courtyard, or open space.

As a consequence, users or passersby are induced to pause and to engage in a change in form or pattern of > movement. This change, articulated by means of the joint, receives an attentiveness that would not be claimed by an unobstructed pattern or path of movement. If the joint appears at a key

location or nodal point within a > spatial structure, it may serve as a decisive point of departure for the intellectual comprehension of that spatial > order, i.e. by rendering it readable from that point.

Kinaesthesia > body (human), gaze, haptic qualities, movement, sensory perception, space

Kitchen > furnishing

Lamp > furnishing, gathering, interior, light

Landscape Landscape is an element of architecture – not just in the form of landscape architecture, but also by virtue of the way in which its formal coherence – regardless of how it came about – fosters a characteristic spatial experience.

A precondition for this contribution is the aesthetic experience of landscape in general, which has only actually existed in relation to our modern understanding of the term since the fourteenth century (Francesco Petrararch). A landscape may be regarded as architecture, and may be perceived as shaping space and generating atmosphere, without its having been necessarily processed into a work of landscape architecture. Alongside elements produced by human beings, albeit without architectural intentions, certain natural forms at times assume an architectural appearance – that is to say, resemble human creations.

Interpreted architecturally, clearings or valleys, for example, resemble interiors, chasms or roadways appear like corridors, constrictions are gates, and rocky ledges are balconies. Topographical formations, with their masses, ledges and incisions, correspond to the volumes and cavities of buildings. The landscape has inherent boundaries for the purpose of subdividing and articulating it, for example lakefronts, forest



edges, and the edges of slopes, as well as canals, streets, railway lines and border fences. The spatial > sequences found in architecture correspond on the scale of the landscape, for example, to transitions from dense and dark constrictions to looser, lighter, more open terrain; a bend in the road may disclose unexpected vistas, the atmosphere may be transformed when a body of water comes into view, a road may be accompanied by the flow of a river, while storage tanks, pylons or large trees may provide points of stability and orientation.

The scale of a landscape, to be sure, goes far beyond that of the building or town. As a consequence, it may provide us with experiences of immense > expansiveness. We move differently in a landscape than we do in a building or town, and movements are governed by a different temporality; when traversing a forest, for example, considerable time may pass before we enter a clearing, a motorway may seem endlessly long before our goal is reached, and a vista may open up only after a seemingly endless ascent. And a kind of goalless strolling is a typical mode of movement of not 'crossing' a landscape, but instead allowing ourselves to be led in a relaxed > roaming style, without troubling ourselves about our goal or speed of travel. Another characteristic way of perceiving the landscape is typical of train travel. While our bodies do not move, our gaze through the window thwart the direction of movement, so that the landscape seems to move, with foreground, middle ground and background shifting against one another like staggered stage sets.

Moreover, a landscape may be characterized by a specific spatial gesture, for instance, the expansive embrace of a sloping dell, the sweep into the distance of overland cables or electric poles, or the majestic rotating forms of a wind energy park. Finally, landscapes are dominated by peculiar atmospheres, for instance, the inward mood of large bodies of water when the wind is still, the ominous, mysterious effect of a dense wood, or the shimmering atmosphere of a cleared alluvial plain with fine grass.

In principle, all of these features represent the spatial potential of the respective terrain, which may be exploited and enhanced by landscape architecture, but also interpreted idiosyncratically. Through modest, isolated interventions, key locations and spatial features may be exposed and latent structures allowed to emerge, so that the character of a > place becomes more distinctive. Individual architectural structures may allow special features of the landscape to be taken up and clarified, the topography of a terrain emphasized through insertions or additions, or the introduction of contrasts. Routes and streets are resources for leading through the landscape in such a way that their typical features are spread out before the gaze and transmitted through movement, an example being the motorway planning of Alwin Seifert. A special case is the (English) landscape garden, which painstakingly reshapes the terrain both horticulturally and topographically in order to heighten the naturalness of its appearance. In the process, the landscape becomes a park or > garden.

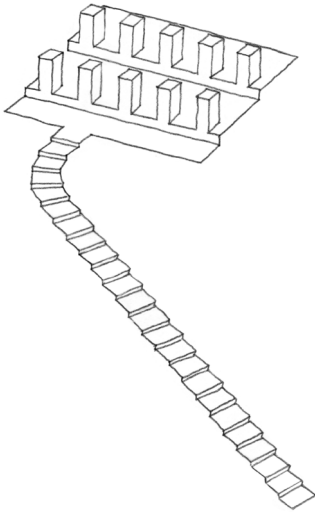

If town planning is regarded as landscape architecture, the design of the city profits from the landscape features and their distinctiveness. While schematic cities laid out on grids seem interchangeable, and the diffuse ‘in-between’ city must combat facelessness, a location along the river or bay, on a summit or in a valley, may endow an entire locality or town with an unmistakable identity.

Layering

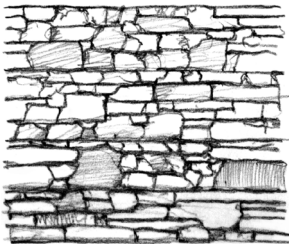

Layering is an elementary procedure in building. Another instrument of architectural stratification is the stacking of rooms on various > levels. In masonry, the horizontal stacking of stone strata illustrates the process of building a wall via layering; here, the layering of masses expresses heaviness and pressure, endowing the structure with stability. In the lengthwise and transverse layering of beams in construction, we see the elementary > tectonics by which a room is roofed. The

overcoming of height is exemplified by the successive vertically layered structure of a flight of stairs. Protection against rain and snow is pictured in the multilayered structure of roofs and ceilings, all the way to the especially powerful expressiveness of the overlapping shingling of roof tiles. Just as fundamental as horizontal layering is the layered structure of a > wall, from Gottfried Semper's tectonic image of the > covering or cladding of a load-bearing framework by a textile envelope, and all the way to the multilayered structure of the > facades of contemporary buildings. Especially in Modernism, the analysis of the various functions of the wall into layers has rendered its diverse functions readable: its load-bearing function, its function as a > filter for views, air, noise and sunlight, and its role as a display surface. Towards the inside, a decorative layer fulfils another task, that of generating specific atmospheres.

The more the covering layer is detached from the wall, the more the layering of materials becomes a layering of space (> space-containing wall). The passage from one room to another is graduated through > intermediate spaces. Such effects can contribute to a delayed approach of and prolonged penetration into a space, and hence offer a richer experience of spatial > depth, even within a relatively confined space. In traditional Chinese gardens, the effects of layering structural and natural elements are multiplied by the phenomenon of *oku* to a densification of space that is perceptible only in stepwise fashion. The basin-shaped spaces of an > incorporation are effected by interlocking concentric layers which are separated from one another by more-or-less clear divisions.

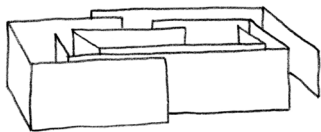

- Layout > composition, concept (architectural), detail, joint, spatial structure, structure, tectonics
- Legibility > meaning, readability, sign
- Level > ascent, ceiling, depth, facade, folding, gallery, garden, ground, layering, plane

Light

Light and shadow are as essential to architecture as form and material. It is not simply a question of choosing the suitable lighting conditions in order to facilitate specific activities, but also and primarily of the structural, dynamic and atmospheric role of light. Light always operates in interplay with shadow, and is perceived as the complement and counterpart of darkness. In architecture, then, it is simultaneously a question of the appropriate handling of > darkness and of its relationship to light. Light in architecture fulfils a number of tasks: it allows solid elements to appear three-dimensional, and shapes the character of spaces through types of openings (1). Brightness and darkness are decisive resources for articulating space, as well as for guiding movement through spaces (2). The character and treatment of light in connection with materiality is particularly crucial for generating atmospheric mood (3).

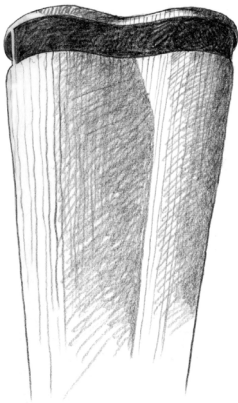

1. The plasticity of architectural forms and three-dimensional elements becomes graspable only when they are modelled through the distribution of light and shadow. Depending upon the three-dimensional shaping of forms and the incidence of light, the variation in distribution of light is readable along edges, changes of direction, and curvatures. Depressions, cavities, joints and surface reliefs become visible in lateral lighting, while forms remain flat when lit frontally. In changing daylight, which grazes over surfaces (> surface), whether uniformly or in streaks and spots, forms are enlivened by the changing position of the sun and the shifting or variable illumination caused by clouds, weather conditions, and changing vegetation. Their inherently dull masses are transformed by increasing and decreasing degrees of lightness and darkness, which wander across their surfaces, oscillating or flickering.

The principal role is played by natural light. 'A space can never reach its place in architecture without natural light', claimed Louis I. Kahn. Only daylight can generate dynamics of movement, changing colour, and fluctuating intensity. It is

primarily a question of where it is admitted, directed, filtered, distributed and concentrated. It either breaks with searing force through wall openings, flows along or grazes them, or seeps into joints and cavities. As mediators between > inside and outside, brightness and darkness, windows determine through their dimensions and formats whether light divides a room by individual > apertures into bright window zones and dark shadow zones, or instead illuminates it uniformly through glazing.

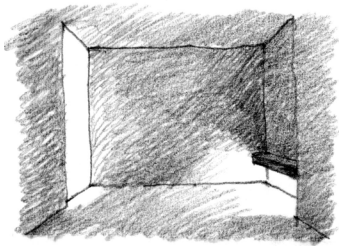

The character and > gesture of a room is dependent in essential ways upon the positions of light apertures. A window in the corner of a room, or a slit that is not necessarily visible at all, illuminates the adjacent lateral wall sections with raking light, suggesting continuity with the outside. It models the surface of a shallow relief, thereby endowing the wall with a lively substance. A ceiling that receives lateral light through a light gap seems to hover. Windows close to the floor illuminate that area in particular, giving it a special quality that may be read as an invitation to be seated there. Very tall > windows, on the other hand, endow a room with an erect, ascending gesture, at the same time bringing light into its depths. Through the intensive zenithal light, a window that takes the form of a ceiling aperture, and in particular a glazed roof, assumes an outdoor character, while in the space itself, the uniform light seems unvaried and monotonous. If this is not combined with windows that provide views towards the outside, one feels cut off from the outer world.

In contrast, light that is reflected from a very bright floor can give the impression that objects and figures float in space. A glazed volume resembles a lantern, and functions as a light-catcher when visible outwardly, while appearing as a compact illuminated body when inverted, as in Rudolf Schwarz's church of St Anna in Düren. Windows in the form of slits and perforations shelter the gaze while nonetheless allowing light and air to enter; this creates connections without really opening the room up.

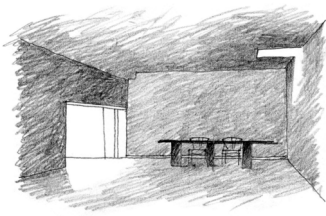

The combination of light apertures on various sides avoids having figures and objects appear only as silhouettes due to backlighting. Alongside large windows to provide background brightness, additional small apertures provide accents while shifting individual activities at workplaces or sitting areas into the appropriate light. Other astonishing spatial effects can be achieved by means of double-shell structures with staggered openings, through which light is guided and distributed as though through channels, as in the Baroque era. In Balthasar Neumann's Church of the Fourteen Saints, for example, the main space is surrounded by an illuminated spatial layer. As the light passes through openings from various directions, the passage of time throughout the day is experienced through migrating fields of light, shadows, and luminous atmosphere, an example being the rotating shafts of sunlight in Erik Gunnar Asplund's cylindrical library in Stockholm.

Light renders architectural and spatial structures identifiable. Illuminated forms are thrown into relief against dark backgrounds, and shadowed figures against bright ones, configuring figure/ground relationships. The shadow zone of an open ground level detaches architectural mass from the earth. The shadowed edges of eaves delimit the building overhead. Architectural structures are articulated by the shadows cast by window frames, profiles and joints. Gradations of brightness ranging from the outside towards the interior begin with the darkness found under roof overhangs, and continue into the depths of the house in a series of staggered levels, as cultivated in particular in the traditional Japanese house through finely regulated filtering (> filter) using grating, folding screens, and sliding paper doors (shoji). At times, however, distributions of light and shadow render structural and spatial forms ambiguous, for example through the nebulous effects of diffuse or translucent materials, or when light filtered through lamellae envelops everything in a unifying pattern of stripes.

2. A room's > use and mode of occupation is as strongly influenced by light and shadow as it is by size and shape.

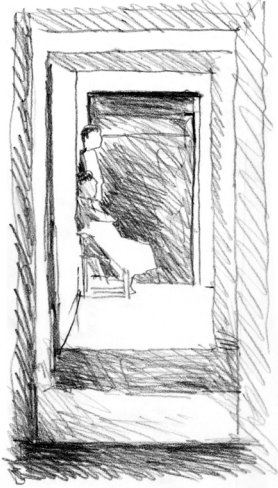

Changes between light and shadow serve to articulate and distinguish parts of a house and effect the internal zoning of activity areas. Formed by fields or cones of light, whether the globe of a lamp, or the zone where wall and floor are illuminated by the sun, islands of light are set off in relation to the surrounding darker space. These become areas of either retreat or conviviality, and are defined as spatial units without the need for additional boundaries. Or they demarcate settings where exceptional events are enacted on illuminated 'stages'. Uniformly and neutrally illuminated spaces, by contrast, lend themselves less to differentiated behaviour, and may even tire by offering too little stimulation. When light drives darkness from every corner, objects lose their substance and plasticity, and the room its depth. The leeway for expansion of > personal space also seems to become flattened out.

Spatial rhythms feed on lighting contrasts, as Louis I. Kahn pointed out: 'A column and a column brings light between them. To make a column which grows out of the wall and which makes its own rhythm of no-light, light, no-light, light: that is the marvel of the artist.' (Büttiker 1993, 18) Likewise, the changing lighting conditions in a > sequence of rooms lead from one room to the next. In relation to such sequential passage, however, dramatically deployed contrasts of light and dark require adjustment. When we enter a dark room after standing in blinding sunlight, for example, our mental state changes abruptly while we grow accustomed to the reduced illumination. Such contrasts can be moderated by means of > intermediate spaces that are kept in half-light. Gradual transitions mediate between the intimacy of interiors and the public character of the outside. Humans are phototropic animals; we tend to move towards light. We can be led around a corner, lured towards a goal: a bright room at the end of a dark corridor seems like an important, illuminated scene. Every designed space has its own form of lighting, through which it is endowed with a specific gesture. Rooms are centred or oriented by means of light, and acquire

dynamism through directed tracks of light, the progression of intensity or the distribution of illumination, for example, side lighting, or light that trickles downward, becoming weaker lower down, thereby directing an expectant, upwards gesture.

3. From harsh white light to warm lamplight, the quality of light is shaped by colour. Louis I. Kahn, however, argued: ‘Artificial light is the light of night expressed in positioned chandeliers not to be compared with the unpredictable play of natural light ...’ (Büttiker 1993, 36) The quality of daylight, on the other hand, is dependent upon cardinal direction: with its freshness, the greyish-yellow eastern light that falls from a lower angle, with its soft shadows, is appropriate to awakening; the southern light displays clear colours, casts strong, sharp shadows, and promotes activity; the golden-orange western light penetrates deeply into the house, announcing the close of the day; the pale, grey northern light, by contrast, seems sober, neutral and diffuse. Daylight, moreover, has contrasting regional characteristics. Mediterranean light is strikingly different from that of northern Europe, and both strongly shape the singular personalities of towns and landscapes in the respective regions.

The regulation of light intensity allows an infinite number of nuances to create transitions between brightness and darkness. Yet Louis I. Kahn believed that ‘Even a space intended to be dark should have just enough light from some mysterious opening to tell us how dark it really is.’ (Büttiker 1993, 36) Gradations of intensity can be created by filtered or reflected light, i.e. by grilles or lamellae, by *brise-soleils* which break up the sunlight without blocking it, by translucent coverings such as curtains, or by shoji, which also serve as projection surfaces for the play of shadows from the other side. Nontransparent windows like the diaphanous surfaces of the Gothic era serve as luminous walls through which a church interior appears as though encased in an envelope of light (Jantzen 1957). Deflection allows light to enter a room indi-

rectly, i.e. by being reflected from surfaces or masses, thereby accentuating their three-dimensionality. The surfaces that the light encounters either absorb much of it, or reflect it with decreased intensity, thereby transmitting something of their colour and surface character.

The light explores the material properties of bodies and surfaces. Because the gaze summons imagined tactile impressions, to see means to touch with the eye. Side lighting is best suited to forming shadows on textures; deep light brings out the shimmer of stucco lustrato. Behind an effulgent or matt shimmering light, objects may become indistinct, but also more strongly contoured, their appearance enhanced. In the darkness, gold leaf catches the light, gleaming forth from the depths of the space. Diffusion of light dematerializes surfaces, softening and dissolving them and creating effects of spatial depth into which light penetrates. Objects then seem to be illuminated from within, thereby evoking enigmatic, almost supernatural phenomena. The impression made by materials and surfaces is dependent in decisive ways upon lighting. For this reason, Peter Zumthor (2004) has proposed deploying materials in architecture only after investigating the reflective properties of their surfaces.

Shafts and cones of light are perceptible only through their reflections, not in and of themselves. Despite their immateriality, they can be rendered visible, materialized, so to speak. In dusty air, smoke or moisture, they may be visible as shaped light volumes. In place of dust particles or water droplets, 'clusters' of larger material particles too may be endowed with form via their reflections, for example, the metal plates in Harry Bertioia's cylinder of light in the MIT Chapel. Filigree latticework and grid structures can also capture sunlight. Supports or pillars set directly below skylights, as in Axel Schultes's Crematorium in Treptow, are material receptors designed to transmit light that falls into the room from above.

The spectrum of the spatial atmospheres that lighting can achieve extend from the dimly lit cosiness of a living

room in an evening to the gleaming brilliance of a festival, from the mystical gloom of a place of worship to the antiseptic and businesslike lighting of the workplace. Alongside the limitless possibilities for generating atmospheric effects and scenarios through artificial light, many contrasting moods can be shaped by daylight as well. Panoramic windows and broad glazed surfaces display rooms and their contents clearly in bright light, banishing mystery, while the imagination and daydreaming are fostered by reduced light and shadow. In refracted light, objects become indistinct. Reductions of contrast and colour are associated with stillness. When dim conditions interfere with vision, the zone of visibility seems constricted. Darkness, finally, seems to harbour the obscure, the inscrutable. The strongly muted light generated in some sacred spaces by the use of stained glass has been characterized by Gernot Böhme (1998) as an enveloping and sheltering form of reduced light, a luminosity without source that is set against a background of ominous darkness.

A mood appropriate to liturgical > ritual is created through solemn illumination. In dim light, the presence of a penetrating, brighter light is a striking event. A zenithal light in the form of a direct beam of sunlight has a numinous effect. Additionally, Étienne-Louis Boullée observed that when 'light is admitted into a room without the beholder perceiving its source, the effect of this mysterious daylight makes an impression of unfathomability, in a certain sense creates a genuinely magical atmosphere.' (1987, 195) The harsh contrasts of light and shadow found in southern lands, for example, in > arcades, at times conjure moods that are reminiscent of the peculiarly inscrutable architecture found in paintings by Giorgio de Chirico.

Literature: Böhme 1998, 2006; Büttiker 1993; Plummer 2003

Lighting
Lightness

> light, opening, window
 > heaviness and lightness

Load-bearing frame > covering, detail, layering, structure, tectonics
Loading > ground, heaviness and lightness, layering, structure, tectonics
Locale > movement, sequence, spatial structure, route
Location > context, landscape, place, residence, structure, urban design
Lock > intermediate space, threshold
Loggia > arcade, hall, intermediate space, space-containing wall, square and street

Mass/massiveness > body (architectural), density (spatial), heaviness and lightness, materiality, poché, porosity, space-body continuum
Material > materiality

Materiality

That architecture, down to its smallest details, is able to stimulate our senses is due to its materiality. To be sure, architecture as ‘imagined space’ (Boudon 1991), as a concept, or as a drawn design, is recognizable already on an intelligible level. As pure form, it can be presented abstractly in a scale model, yet it begins to affect our senses only once it has been tangibly materialized. In the absence of a sensitive and differentiated materialization, even a real building often makes a peculiarly abstract, intellectual or formalist impression. The term ‘materiality’ refers not only to the circumstance that architecture is realized with the assistance of building materials, but also to the fact that a material expresses its specific properties and idiosyncrasies through its outward appearance, so that characteristic > appeals emanate from it.

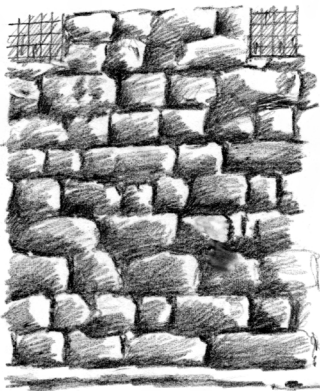

All of our senses participate in the perception of materiality, to some extent through > synaesthesia as well. The > haptic aspect has priority, of course, but > sound and > aroma are decisive as well, and even the sense of taste can be synaesthetically effective. Vision, on the other hand, does not deliver the most intensive experience, as it does in perceptions of form, but instead so to speak transmits visual stimuli onward towards haptic perceptual capacities. Not only can

surfaces be touched, they can also be scanned visually as an extension of the haptic sense: we see the way something feels to the touch, and at times, even how it smells or tastes. A specific sensory experience is offered by the contact of our feet with the floor; our movements are influenced by characteristics such as vibration behaviour, roughness or smoothness, solidity or elasticity. While certain material properties are perceived primarily through their surfaces via the sense of touch, through the absorption and reflection of noise, light and moisture, and through the conduction of warmth, some characteristics reside in the depths of the material, and can be identified only by knocking on them, for example. By being percussed, the material may reveal its solidity or > porosity, its > heaviness or lightness, and its resonance.

Depending upon their treatments, > surfaces will have different material effects. The coarse appearance of a roughly sawn wooden surface contrasts strongly with the polished surface of a piece of Biedermeier furniture that has been worked painstakingly with thin layers of shellac. In this context, it becomes evident that despite clichés about its supposedly ‘warm’ character, wood can project highly divergent traits. Likewise, the widely prevalent phobia against concrete rests to some extent upon clichés that disregard the variety of its handling. A subtly fabricated concrete interior wall by Tadao Ando makes an intimate, velvety impression possibly reminiscent of the lining of a jewellery case, while the roughness of a board-pressed *béton brut* outer wall by Le Corbusier evokes the layering of masonry. The impression made by fine material is dependent upon suitable treatment, while careless handling can make even the most precious material seem false. Certain processing techniques are typical for specific materials, and may emphasize its special traits. The character of a material, its porosity, grain or veining, is revealed through its texture (surface structure, polish, light refraction). Texture can be exploited as an > ornament for enlivening a surface, and is, as Adolf Loos pointed out, ‘far superior in delicacy’ to artificially

produced ornamentation. A distinctive formal language can be developed from the specific possibilities of treatment that are available to a given material.

Materials address our senses to varying degrees, attract us, want to be touched, and either bring us into physical contact with the architecture or hold us at a distance. The impact of materiality may single out special features, as with the mosaic cladding of a mihrab, or may generate emphasis through its uniformity. Various forms of perception work together. Contributing to the stony aura of a Romanesque church, for example, are its closed, unified mass, its solidity, the coolness inside, and the hard acoustics, which reinforce one another to express invulnerability and permanence. A wooden cabin in the mountains, on the other hand, evokes the impression of a rough case through the interplay of fibrous materiality, resinous aroma, sonorous creaking, and warmth to the touch.

For the most part, the properties of materials are not perceived in isolation, but in their interaction with other materials, which modulate, contrast, or accentuate one another. In the right proportions, a variety of materials can be coordinated with one another to shape the atmosphere of the room so that it ‘resounds’ with a characteristic chord. ‘It vibrates with gaiety,’ commented a contemporary on the boudoir in the Villa Müller, where Adolf Loos combined panelling in satinwood veneer and fine cretonne with rose-patterned upholstery. Another example is Erwin Heerichs’ exhibition pavilions in Hombroich, whose rough exterior in reused clinker brick contrasts with the gleaming white plastered surfaces of the interior walls in a way that is reminiscent of a winter coat in coarse material with a fine silk lining. Complementing this harmony through modulating intermediate tones are natural wood doors lined with sheet metal.

The differentiated deployment of materiality clarifies architectural structure through contrasts of materials at significant locations such as bases, edges, apertures and mouldings, or the concretization of architectural situations with

> invitation character. Transitions of materiality from hard and cold to soft and warm can help to guide from exterior to interior, for example when pavement indicates a public character and textile flooring invites us to feel at home. The material endows an intended use with expression, while recording traces of daily use. Such visible traces indicate aging while, especially when combined with > patina, possessing their own dignity. They suggest the solidity of architectural elements, their social significance, while the application of locally typical materials inserts them into regional traditions, contributing to their rootedness in a specific > place or > context.

In some instances, the structural properties of materials convey the expressive features of an architectural style. With its bubbles and flowing structure, the travertine that was preferred in the Roman Baroque, for example, expresses a dynamically fluid and massively tumescent > form character, and was hence referred to by Giorgio Vasari tellingly as *congelatione di terra e d'aqua*, a frozen mixture of water and earth. The enormous importance of materiality in architecture was characterized by Adolf Loos: 'Material must be divinized once again. It consists of almost mysterious substances. We must marvel deeply and reverentially over the fact that anything like them could have been created in the first place.' (Loos 2002c)

Literature: Böhme 1995b; Roth 1995; Soentgen 1997; Weston 2003

Meaning

Architecture conveys meanings. As a result, it transcends the physical and technical facticity of built form. By the significance of architecture, on the one hand, we may refer to its prominence, its cultural ranking, or its influence in history. On the other, architecture, also always conveys meaning in the form of references to specific messages or contents. We are not just surrounded by architectural forms and walls, but

are also confronted from all sides with that which these forms – whether individually or in their interaction – signify or express, or to which they refer, whether openly or subliminally, whether intentionally or inadvertently. Playing a role here are individual and collective models of interpretation, which are in turn conditioned by cultural frames of interpretation and social norms.

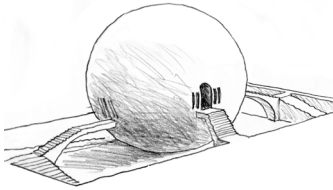

The relationships between architectural form and meaning are highly diverse in nature. For one thing, meaning and architecture can be conveyed in the form of > signs, the teacher whose comprehension is supplied by cultural conventions or specialized knowledge. In such instances, one must have learned to read signs and to interpret their significance. A city or a building is expected to have > readability, which allows us, for example, to recognize the building's organization or intended use, or to understand pictorial messages and iconographic contents. By providing such signals, indicative forms allude to relationships that lie behind the surface and are not necessarily experienced in a given situation. The positioning of staircases, for example, can be read off from the openings in the facade, and a building's date of construction is legible in its ornamentation.

Such signals, however, may go far beyond the respective situation in space and time, and ultimately can signify, represent or narrate something that lies outside the architecture, and to which it alludes only indirectly. At times, anecdotal allusions, for example, narrative illustrations of a story, a business concept, or a reference to the personality of a former occupant, have only a subordinate relation to the present situation itself.

For another thing, we grasp the expressive character of a built form directly and in perceptual terms without the need to read meaning by deciphering architectural forms, especially those that have an impact on us in a given situation: the immediate > expression of features we assign to built forms, spaces, or situations themselves, for example those that

gather, disperse, align or enclose, in particular as dynamic qualities of architectural > gesture. These include > invitation characters that suggest specific modes of behaviour or attitudes, and the > appeals that convey moods, awaken expectations, or summon specific reactions. Such expressive values do not simply designate objects, but also play undeniable roles for the respective situation itself. The functional organization need not be conveyed by signs and read, for instance, distinctions between various spatial uses by means of special markers on access doors, orientation via coloured signatures for the levels of parking garages, or the identification of sanitary facilities by pictograms, but can also be rendered evident via the form, arrangement or atmosphere of the various rooms.

In many instances, interconnections or fluid transitions exist between meanings conveyed by signs and unmediated expression. This is particularly the case for > symbols, metaphors, and > images, which, although they represent something that is found outside the given situation, they also contribute to the concrete spatial experience through their forms. When the form of a vault resembles a sail, or is reminiscent of a grove of palm trees, it alludes to something extra-architectural, but may at the same time convey an intended spatial sensation. Rudolf Arnheim spoke of the double task of architecture, to be simultaneously 'self-image' and an image of something else. Through their forms, buildings refer to themselves, that is to say, to their concrete use, while making symbolic statements about their general relationship to the world, to the local or historical context, expressing a particular notion of habitation, a specific lifestyle, an attitude, or perhaps a social status.

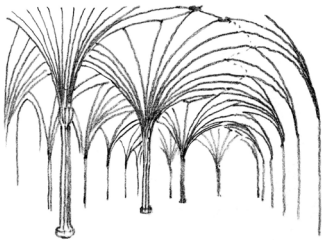

However, conflict may arise between these two types of meaning, for example when an additional meaning is superimposed upon an unmediated expression of the spatial form, and when this divergent statement falsifies the architecture's primary impact. An example might be the setting of a pyramid on top of a conference room, which ought simply to in-

vite people to assemble by means of the expressive force of the central structural and spatial form, thereby imposing on it an inappropriate emblem more characteristic of an imperial monument. Through the *Prägnanz* of a design, however, architectural and spatial forms may also display an open-ended significance, thereby possessing a semantic > capacity that enables them to embrace changing meanings.

Measure

There is no guarantee that architecture becomes more human when the dimensions of the human body become its > measure. Certainly, measure plays a role in spatial experience – not solely through objectively quantifiable measurement, but also through its interaction with other conditions of perception and movement and with subjective attitudes. As the bases of > order and > composition, measure is also significant for intellectual intelligibility.

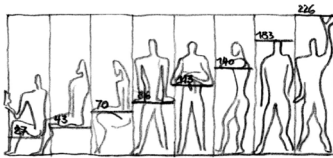

Ordered systems of measure, such as Le Corbusier's *Modulor*, assume that attentiveness in the design process to the dimensions of the human body, its range of movement, the length of a step, make it possible to relate oneself, in the context of spatial experience of the situation, to the consistent proportions of a building. In fact, the dimensions of the human body play a role for many movements and the performance of many actions. The height of the head is decisive for ceilings and door lintels, the height of the eyes for lines of sight, and the provision of view protection. The accessibility of a door handle or the height of the step required to climb a set of stairs is related to the dimensions and the reach of the limbs. A visual angle with an aperture dimension of approximately 60° determines the visual field. Its opening angle in height – about 27° , according to Hermann Maertens (1877) has consequences for the effects of > enclosedness of spaces and public squares. The approximate space requirement for certain activities can also be determined dimensionally. Even our relationships with other people and with our social envi-

ronment are conditioned by spatial measurements, from the distance between our eyes and those of someone else, as determined for example by the width of a dining table, all the way to the distances in urban space that condition our daily radius of action.

Our bodily spatial requirements, however, go beyond such measurable magnitudes. Our space requirements for everyday activities cannot be prescribed according to the purely functional planning standards of the relevant handbooks (Neufert 2000), but must instead incorporate the buffer or > resonance spaces that are demanded by our > personal space in relation to individual attitudes, tendencies towards expansion, and habits of movement. The headroom, for example, that is required for a habitable room cannot be calculated on the basis of the physical dimensions of the user; instead, the 'upright gait' requires the leeway that is provided by additional height. In experiential space, distances are perceived subjectively: familiar objects and people seem closer than they actually are, while distant objects may be perceived as proximate. While concepts such as size, expanse or distance can of course be grasped in terms of external dimensions, they are also qualitative features of lived situations that cannot be objectively measured or quantified. This applies to the dimensions of a building as well. We receive an impression of the > size of a building or of a room not only by determining its dimensions, but also through the relationship between the > details and the whole and our position in relation to it. The sense of > expansiveness and constriction of a room is dependent not just upon the distances between walls, but also by the perspectively perceived interplay of all of the constructive elements that delimit the space, and by changing conditions of visibility.

Alongside our physical experience of a space and our sensory perceptions of form, intelligible proportions represent a further level of access to architectural space, one that satisfies the intellect; this is the view of Hans van der Laan,

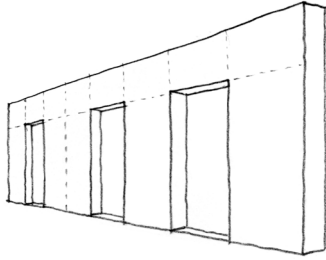

who has characterized the relationship between these three 'levels of human existence'. 'The understanding wants to be informed about spatial extension, and this occurs in terms of quantity'; it is not grasped directly, but instead by means of numbers. (Van der Laan 1983, 16) Spatial extension becomes perceptible when the dimensions of the bodily masses that form a given space are compared with a recognizable unit of size (module). Just as in music, the basic unit of the beat makes it possible to comprehend the organization and rhythmic structure of a composition, the quantifiability of a basic unit of measure allows us to recognize the harmonious relationship between > row and grid, or renders clearly evident the design intention of the rhythm of a spatial arrangement. The > proportions that are developed from a system of measurement that dominate the space they form offer the satisfaction of intellectual comprehension. Experienced casually, however, a perfected order of measure does not provide the same experiential content as it does when perceived by an attentive user who is sensitized to dimensional features. For the moving observer, the difficulty is to perceive dimensions and proportions with adequate definiteness in quickly changing spatial situations. To be sure, dimensional consistency is also experienced incidentally and intuitively. In order to grasp proportional relationships fully, however, the spatial situation must be read repeatedly and carefully like a poem as a 'dense text' of multiple interrelationships; this brings about intensification, but also requires contemplation.

Literature: Van der Laan 1983

Memory

The German word for memory, *Erinnerung* – with its implications of recollection and internalization – is suggestive in our context: to absorb a situation as a totality, i.e. in its temporal unfolding as well, means to integrate the individual impressions that emerge in conjunction and successively. Strictly speaking, then, active memory begins already with the con-

catenation of small, temporally disjunctive perceptual steps. In order to form a total impression, we must retain what we have seen a moment earlier, i.e. after turning our heads in a different direction to take in a fresh impression.

In traversing a room, a town or a landscape, we acquire a mental presentation of the whole only by recollecting sufficiently the rooms or zones through which we have passed, and how these relate to one another. We automatically construct a complete mental image in relation to which we orient the coordination of various memories. This memory image then allows us to find our way. But it may also reveal discrepancies, as when the parts of a building – i.e. exterior and interior – cannot be reconciled with one another, whether through deficiencies or with dramaturgical intention.

Memorability, however, requires more than the visual impression alone. For certain situations, our memory is oriented more towards bodily experience, simply because a specific movement – those associated with ascending a staircase, grasping a handrail, or opening a heavy door – have been imprinted in memory incisively as a > figure of movement.

An individual's personal lifestyle and habits are reflected in the reshaping of the architectural design of his or her living space as a kind of imprint of daily behaviour. They are primarily legible in everyday furnishings, but also leave permanent identifying traces in the architectural substance as well. Because we link actions and events to places and spaces and anchor these in memory (as practised in antiquity through mnemonics), we are able to summon them to memory when re-entering these places, bringing them to life again or registering transformations.

Memory plays a role on another temporal scale as well, i.e. when we read architecture as a testimony of history, a function to which it is suited like virtually no other medium. This function is concentrated in the > monument, but not only there. As forms of collective memory, and by virtue of their permanence and stability, architecture and the city first of all sup-

port memory, provide our perceptions with temporal depth, thereby providing opportunities for engaging in dialogue with history. Second, memory is always interpretation. We are able to attribute new significance to the contents of architectural memory, thereby reinterpreting the past and preventing it from becoming fossilized. At the same time, memory fades through familiarity and habituation to the constant presence of objects and buildings, allowing them to become invisible.

Metaphor	> form character, image, inside and outside, meaning, sign, symbol
Middle	> centring, circulation
Mirror symmetry	> symmetry
Module	> composition, measure, order, proportion, scale
Monotony	> complexity, dramaturgy, order, sequence, simplicity

Monument

Concentrated in the monument is the architectural task of serving as a bearer of meaning in two senses. First, as an architectural monument where historical witness, genius loci, and social representation overlay one another. Second, the monument serves a structural function for a town or city, and possesses validity beyond its historical significance; monuments are key elements within the urban structure or landmarks of incisive design.

As unrepeatably historical witnesses into which the traces of the passage of time have been deposited, monuments emanate what Walter Benjamin (1936/2006) referred to as the uniqueness of the aura. As the sensuous substrate of historical events, a monument (Latin: *monere*, ‘to remember, to remind’) makes the original milieu of a > place, or the culture of a past epoch, immediately accessible and atmospherically vivid. Many monuments have been reinterpreted and reused in various ways through successive different epochs; diverse layers of history are sedimented in them.

The significance of monuments rests on their social tasks; a town hall, for example, embodies the polity, a palace authority; a cathedral the role of religion and of the church. As manifestations of political life and of world views, monuments express the relationships of people to their epochs and their societies in concentrated and aesthetically effective ways. Speaking through them are both everyday rituals as well as the prestige requirements of past epochs. In the present, this function is assumed by public buildings, which will in turn become the monuments of tomorrow. Today, banks can be regarded as monuments of financial power, and museums as memorials of the culture industry.

It is possible to adopt a variety of attitudes in relation to historic monuments: we can surrender to the other elegiac mood of transitoriness, to feel repelled by the false monumentality of quasi-sacred demonstrations of power, or simply allow these now 'invisible' relics of the past to escape our attention altogether. Nonetheless, monuments address us to the extent that they confront us directly with history – and to some extent, our own history. They provide opportunities to contemplate the passage of > time and to enter into dialogue with history and with the site of historical events (> memory). Through them, we can situate and interpret our own situations, and position ourselves in relation to them through adequate interventions. On the one hand, a monument can be read in relation to its historical significance; on the other, current meanings may be ascribed to it, reframing it, thereby reinterpreting both the past and the present. But monuments may also set limits to memory; we can simply go around them and continue on our way.

The adjective *monumental*, meaning 'colossal', refers to the fact that monuments are often particularly imposing and well-fortified buildings that are designed for permanence, and that would be difficult to demolish by virtue of their solidity and > size. But as recent exemplars have demonstrated, monuments – which, alongside buildings, also include purely

artistic memorials (sculptures) – need not necessarily assume such a monumental appearance. For a structure to function as a monument, its design features must contain a special semantic > capacity. This capacity for taking up and emanating meaning rests mainly on qualities of design *Prägnanz* that are heightened further by a surrounding, creating a sense of distance. Bearing pronounced semantic capacity are historically meaningful forms that have lost their contents and now offer themselves to be charged with new meanings (> type). The overwhelming and sublime impact of monuments often derives from the dignity conferred by age, and from their provenance from a world that we no longer understand, and can hardly explain verbally. In their archaic power and historical distance, they often seem enigmatic and foreign, and yet all the more laden with meaning.

But monuments also derive great significance from their urbanistic function within a spatial structural fabric. Here, too, their memorial character, their representative function, and their design *Prägnanz* play decisive roles. With reference to monuments, we orient ourselves spatially not only within a town, but also in relation to its historical and social structure. Aldo Rossi has referred to architectural monuments as the ‘primary elements’ of a town, as they are ‘constitutive components’, which form the ‘actual structure of a town’ by virtue of their collective and public character and their relatedness to a specific site (1966/1982). Monuments are set off as striking objects, buildings, staircase structures, or > public squares from the uniform developmental texture of the town as a homogeneous ground, giving it an unmistakable character as a scaffolding of key points. When they are situated at strategically important positions, for example as entryways to a town, at topographically striking places, or as the poles and arrival points of > axes, a characteristic network of spatial relationships emerges between them, not unlike the one that Sixtus V had laid out in Rome. On the one hand, this urbanistic scaffolding is readable as traces of past urban de-

velopment; on the other, it supplies reference points for future development.

Literature: Rossi 1966/1982

Mood

> appeal, atmosphere, colour, darkness, form character, light, odour, sound

Movement

In legalese, buildings are referred to as ‘immovable property’; they are regarded as being immobile and static, and we rely upon their durability and rootedness in one place. Despite this, an essential trait of architecture is that it can be adequately experienced only through movement. Fundamental to the spatiality of every built complex – no matter how solidly grounded it may be – is its comprehensibility as a totality only through the adoption of a variety of positions and perspectives. Architecture and movement condition one another reciprocally. The movements needed to perceive a building are dependent upon its spatial > structure, while movements shape our perception of it. Our > sensory perceptions encompass, in particular, the (proprioceptive) sense of position and the (kinaesthetic) sense of movement. The spectrum of types of movement comprises the extreme of rest, including the adoption of certain positions and > postures such as sitting, lying or standing. The influence of various types of movement can extend so far that we may experience a building in completely different ways depending upon the movements or attitudes we adopt when perceiving it. In comparison to the pedestrian’s perspective, locomotion in a vehicle may transform the appearance of buildings, cities and landscapes even further in ways that depend upon the type of transport employed, velocity, and type of vehicle taken. The city of the pleurably strolling flaneur differs from that of the driver in a car who passes through it in order to reach a specific destination, or a skateboarder who reinterprets it experimentally.

Elementary modes of movement can be characterized through (pre-)positions such as approaching, entering, being inside of, traversing and circumambulating, by means of which we probe and grasp the fundamental structures of spaces, in the process relating them to our own physical disposition within space. The body's symmetry, the forward orientation of our sensory organs, and the mechanics of leg movements prescribe the axis that links our bodies to a destination in space as the predominant direction of movement. A feel for spatial > depth is attained through the tension that bridges depth distances, and through the virtual movement that its overcoming demands. For our movements, which are primarily horizontal in most works of architecture, and which encounter walls that guide, arrest and surround us, the ground plan is decisive. It directs movement, guides actors and actions.

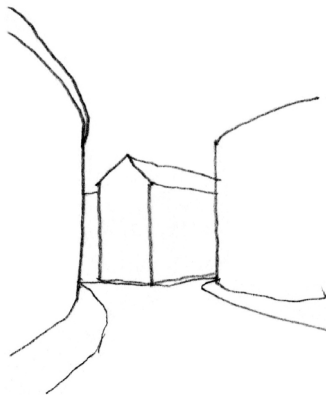
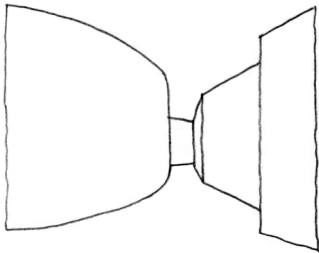

In order to avoid exercising compulsion, architecture conveys suggestions for movement as we traverse it, and the spectrum can be quite wide. By offering openings and passages, it sets movement in motion. It directs via strict channelling, or indicates further stages solely by means of guide walls or prospects, prescribes changes of direction via axial panning, turns or deformations, generates – in ways consistent with the rules of flow – increases or reductions in pressure by narrowing or widening. A > sequence is punctuated by the caesurae of small passages or only by narrowings, which articulate a flowing spatial continuum even in the absence of doors. A route can be split up or branch out through bifurcation; divergent orientations may enter into competition with one another; lengthwise or lateral movements may become superimposed. Finally, movements may be decelerated, arrested or blocked by ‘friction’, for example by means of a sculpturally modelled accompanying wall, barriers or obstacles, until it ends at a spatial terminus. Movements are not only guided laterally by walls, but also oriented by sudden changes of room height; they guide the gaze upwards, yielding, for

example, to the pull of a cupola, and inciting us to ascend, for example on > staircases and ramps. During each phase of movement, the resources of dramaturgy produce expressive effects, arouse expectations, hint at mysteries. They may threaten to engulf us in dark abysses, promise us a celebratory reception in gleaming > light, or awaken sensations of infinity through endless > sequences. The guiding of movement through structure is supported by a tactile network of handrails, doorknobs, or other > details, in particular those involving the treatment of surfaces, differentiations of > colour and > materiality. Floorings, for example, may signal either continuity or a transition between stages or directions of movement, either subdividing or unifying.

From the perspective of practical action, movements are necessary as connections between > places via > routes. Regarded as hodological spaces (route spaces), buildings and cities are first of all interwoven with networks of routes. But movement plays a role in architecture not solely as forward locomotion; instead, every form of use of a space and the objects it contains is based on purposeful movement. According to Paul Frankl (1908) we can perceive the 'soul' of architecture in its active > use, and movement as 'a bridge leading towards it'.

Beyond practical purposes, a work of architecture provides multifarious possibilities for movement as the basis for a rich spatial experience, as in the promenade architecturale, towards which Le Corbusier strove, and in some cases also fosters intellectual mobility. As the expressive qualities of built forms, the dynamic > form character and > gestures of architecture are often suggestive of actual movement, i.e. when a bridge curves across a river, or a spatial form appears to have been rhythmicized. The result is not only a pictorial, but also a specifically architectural experience, in particular through the concrete re-enactment of the gesture. Differently than in a picture, whose rhythms can be grasped adequately in visual terms, an architectural > rhythm is experienced with spatial intensity only through one's own actual rhythmic forward

movements. Through repeated actions and through familiarity with a given space, movements are often condensed to produce gestalt-like > figures of movement, which leave their mark on bodily experience and remain recallable, thereby providing a basis for > rituals of everyday action.

Narrowness	> expansiveness and constriction
Nature	> courtyard, garden, landscape
Neighbourhood	> access, context, place
Nesting	> enfilade, furnishing, incorporation, layering
Network	> axis, access, context, square and street, structure, urban design
Niche	> angle and corner, furnishing, interior, intermediate space, surface, space-containing wall, space-body continuum
Noise	> comfortableness, sound

Odour

For the most part, the secretive emotional force of odour escapes our conscious control, yet many situations are shaped and affectively charged by odours in unexpectedly strong and far-reaching ways. They are capable of conveying a range of moods, yet have no spatial or architectural character; the spatiality of odour rests on bodily processes, in particular in connection with respiration. In both interior and exterior spaces, for example in gardens, a pleasant, fresh or attractive aroma can convey the impression (i.e. when inhaling deeply through the nose) that we are taking in the space together with the air volume. We experience a sense of breadth, and have the impression of expanding into the space. Conversely, an unpleasant or dusty odour makes inhalation difficult, generating feelings of oppressiveness. Unlike the other senses, our sense of smell does not facilitate the identification of individual forms; odours appear in an immaterial fashion between objects. They hover in the air, are imperceptible at a distance; they spread themselves out, but have no boundaries or directionality.

Nonetheless, constructive-spatial characteristics play a role for the effects of odours. Aside from the expansive or constricting effects of the air quality of spaces, certain odours emanate from building materials, from paint or furnishings, and in open spaces, from plants and from the earth. These are supplemented in a multisensory fashion by vision and sense of touch. Then there are the olfactory traces of residence and use, so that places, buildings and spaces are endowed with a specific character formed by the totality of these components. This character that makes a space unmistakable and identifiable via smell, e.g. underground stations, department stores, manufacturing facilities, and hospitals. Individual apartments are often recognizable on the basis of odour, and a kind of olfactory profile can even be defined for them based on lifestyle and habits (furnishings, cooking, cosmetics). As a consequence, the private spheres of the various occupants become detectable within the staircases of apartment buildings. Entire urban districts can be distinguished from one another clearly based on stable odour identities. And odour can travel from room to room, a nuisance that may even trigger territorial conflicts.

Odours are strongly persistent in memory. The merest trace of a recognizable odour may suffice to bring a past situation to life again, after much time has passed. The characteristic odour of a room, composed of various ingredients, is grasped in an intuitive and holistic fashion as its unique atmosphere, and becomes present suddenly, with all of its connotations. Although it is for the most part effective subliminally, it can at times become unavoidable, an intrusive presence that is even more intense than visual impressions, and one that may even drive us from a room. But since aromas can also attract us, and can generate certain spatial moods, certain fragrances are deployed in targeted ways in specific spatial contexts, for example in religious ceremonies (incense) or in commodity aesthetics (fresh scents). Odour is a resource that has been used traditionally in the art of gardening as a way of gener-

ating various > atmospheres. Given its penetrating character and subliminal effects, aromas are especially well suited to the covert manipulation of emotion. When we remain in a room for a longer period of time, however, an aroma quickly becomes familiar, depriving it of much of its intensity.

Literature: Bischoff 2006

Olfactory sense

> odour, sensory perception

Open/close

> door and gate, opening, window

Opening

Rooms and buildings require openings so that they can be closed off, but also so that the architecture may be enlivened by changing lighting (> light) conditions. Acts of opening and closing condition one another reciprocally; their interplay conforms to the interdependency of division and connection, of > inside and outside. For this reason, a richly varied deployment of openings is decisive for architectural variety – but it is not solely a question of > windows and > doors. When interior rooms open themselves up to the outside, it is basically a question of the nature of the transition or of the switch between spatial characters, from narrowness to expansiveness, from dark to bright, warm to cool, or private to public.

Certain door and window forms or other figures of opening invest use with a specific form of expression – for example the possibility of penetrating from the outside, of breaking out from within; but also the restriction of these actions through narrowness and options for closure – or they provide these uses with frames. Emerging in place of point openings by breaking open corners in the spirit of the ‘destruction of the box’ (Frank Lloyd Wright), or even by dissolving entire wall slabs, are interruptions, intervals and interspaces that encourage the > flow of space in a continuum.

Through > filters, the role of > views into or out of the building or of > ingress and exit and the function of separa-

tion and connection can be varied in graduated ways. Depending on their forms and positioning, openings endow a room with contrasting directionality and gesture. By virtue of their vertical orientation, roof openings – such as the oiaion of the Pantheon – create vertical connections to the skies with a highly direct impact when they admit not only stark zenithal light, but also natural elements such as rainfall. Slits situated directly beneath the ceiling, especially when they run the entire length of the walls, as at Le Corbusier’s Church at Ronchamp, allow the ceiling to float above the room. Since human perception is oriented primarily horizontally, we feel robbed of contact with the outside world in rooms with openings set exclusively above eye level. Openings directly above the floor illuminate the floor zone in particular, endowing it with a specific quality by inviting us to be seated there, one instance of this being the Japanese tatami room. Here, too, the > wall becomes detached from the floor, especially when the floor level continues into the space outside. Vertical wall slits in the corners of the room cast a raking light on the adjacent wall surfaces, which allow the space outside to flow inward together with the light from the outside.

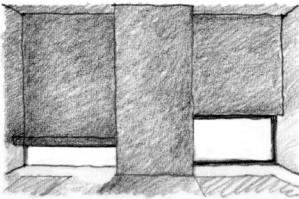

Small apertures and skylights generate various > atmospheres through selective light effects without really opening up the room, and without the need to attend to requirements for views into and out of the space. By these means, for example, > darkness can be generated as an element of a room’s mood, i.e. through tiny openings that allow only a weak glimmer of light to enter. Rays of sunlight that wander across the walls through these individual apertures testify to the passage of > time. In combination with large openings that provide the room with a background level of lighting, small, light holes or slits can provide darker zones with selective illumination and accents. A differentiated distribution of special gaps and individual openings such as spy holes, pass-throughs, trap doors or hatches organizes specialized movements and action sequences in a building.

The variety of types, sizes and positions of openings is visible on the outside of the building – not just on the richness of the > facade design, but also in the plastic treatment through which the structure is sliced open and perforated. These various niches, bay windows, dormers, light cannons, crenels and other types of gaps serve as indications of the diverse intentions and backgrounds of opening and closing.

Literature: Selle 2004

Openness

> capacity, closure, courtyard, landscape, opening, screening

Order

Through architecture, order arrives in the world. It orders the activities taking place in the home, the spatial relationships within a town, and even shapes the landscape to conform to human expectations. Art is fundamental to architecture: ‘Architecturer, c’est mettre en ordre,’ in the words of Le Corbusier. (1933/1974) Architectural reality is characterized by a constant struggle against disorder. In homes, it must cope with the idiosyncrasies of individual lifestyles; in the city, with the divergent societal interests of countless actors; and in the countryside, with the untamed proliferation of nature. Only through a confrontation with disorder does order have value. Often, it is defined only through processes of appropriation. Even when a certain type of architecture takes disorder itself as its theme, and at least initially falls into anarchic attitudes, it arrives eventually – in order to become comprehensible – at a superordinate aesthetic level, a different type of order.

> Sensory perception itself already proceeds in an orderly fashion, organizing disparate stimuli into a > gestalt according to principles and laws of form. And principles of order make themselves felt in all subsequent phases of spatial experience. For the sake of spatial orientation, we must determine the way in which rooms are ordered into a > larger structure, just as > accesses and the distribution of utilizations become

comprehensible through the > readability of their organizational plan. Before architecture can be understood, finally, the ordering principles of architectural > composition and the underlying design > concept must be clearly evident.

Order in architecture is experienced in particular when it is comprehended intellectually. To pursue the interplay of the parts with the whole on various scales according to transparent rules engenders a feeling of security, a kind of mental satisfaction, and in particularly successful instances, even intellectual pleasure. Throughout history, this has been a genuine task of architecture. While rational transparency has generally played a role in the history of architecture as a criterion of quality, it has acted as a special theme in a few instances, for example in the planning of ideal towns, among them Karlsruhe, praised by Heinrich von Kleist: 'It is clear and luminous like a rule, and when we enter it, it is as though we are addressed by an ordered intellect.' (1801/1978, 283) To be sure, the significance of strict order as a symbol of absolutist authority and as a disciplinary resource is difficult to separate from its aesthetic impact.

Historically, it is geometric regularity and measure order in particular that, alongside the classical orders of the columns, formed the basis for all architectural order, for example, in the sense of eurythmia with Vitruvius or concinnitas with Leon Battista Alberti (> beauty). Geometry is one of the timeless resources for organizing architectural forms according to recognizable rules and principles, for example through > symmetry or the repetition, and sequencing (> row) of identical elements, through hierarchical-centric arrangements (> centring), convergent directionality towards a (fictive) point, or axial (> axis) organization. The rational recognition of formal orders is supported by measure, which governs the > proportion of elements and the formal consistency of their relationships. While simple form and regularity are the traditional preconditions of order, freely arranged forms also allow order to be attained. For this to work, they must

possess their own *Prägnanz*, a tension capable of binding the individual elements together.

The technical rationality of a building is usually visible in the ordered appearance of its construction: for a long time, economical building called for the simplification and unification of parts and structures. With the growth of digital planning and project realization, on the other hand, the construction of buildings risks becoming unclear, since highly developed computing programs make possible arbitrary formal decisions and most complicated constructions. Algorithmic orders, however, present themselves in a different way from traditional structures.

Order in architecture is not restricted to the characteristics of static objects and their adequate readability. Alongside orders that follow preconceived ideas, there are others that are generated through the influence of multifarious parameters, and which change, for example, in response to individual use or social appropriation, and at times emerge only through a conflict with a rigid framework of order. Processual order is manifested in the alterable elements of architecture, for example the continual rebuilding of a town or the furnishings of a > home. These types of order are also subject to influences from the > context, and are perceived as part of an order belonging to a superordinate level. During the 'lifecycle' of a building, order is integrated into various systems of utilization, and has recourse to different local or social contextual references accordingly.

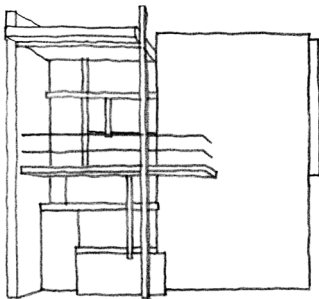

Strong order asserts itself in relation to disturbances, but threatens to become rigid when spared all exposure to adversity. In the realm of perception, it has been established that an angle that diverges slightly from 90° fosters active vision (Seyler 2004). In the Baroque, symmetry was broken by guided asymmetrical movement; in Modernism, static balance is replaced by unstable equilibrium. Order and fulfilled expectation, then, always stand in a complementary relationship to > complexity and surprise. An excessively rigid order,

on the other hand, threatens to turn into repression, regularity into monotony, simplicity into banality.

Oriel

> intermediate space, space-containing wall

Orientation

Through orientation, the spatial disposition of the human individual becomes anchored in the spatial structure of the surroundings. Because we rely on the ability to find our way in space, orientation is a basic precondition for feelings of security and > comfortableness, and a response to the fundamental question: 'Where exactly am I?' Secondly, they form the basis for spatial discoveries and new experiences.

With a point of departure in a sense of situatedness (proprioception) as the foundation for further positioning in space, the > body's orientation is based on the distinction between existential directionality, i.e. above/below, front/back and right/left. Human individuals orient themselves in relation to their own bodily structure, and at the same time in relation to the object structure of the surrounding space. A person gains access to a spatial structure by evaluating directions and points of reference within a given spatial situation for the sake of orientation.

The cardinal points – in particular the direction of the rising sun in the east – still have a literal significance in architecture, in particular for the arrangement of rooms and their uses. In dependence upon the times of day, the changing daylight allows for various > atmospheres in rooms that are oriented towards the cardinal points. Their use is also facilitated by the character of the illumination, which depends on the position of the sun and the changing colours of the light. The directions of the > gaze towards the outside correspond to the various directions from which > light is admitted into the building. Accordingly both a building and its occupants are oriented towards the sky and its various forms of appear-

ance, while a building in particular is oriented in relation to views of the vicinity. The way in which one occupies a building is strongly dependent upon whether it is oriented towards a street, towards a characteristic landscape, or in relation to a specific neighbourhood.

The orientations of individual buildings also determine their interplay within urban space and within the landscape. An architectural > concept responds to this > context in the sense that its orientation towards a river, a public square, or a particular view is reflected in its overall gesture and in the configuration of rooms, their openings, and their > directionality.

The way in which a work of architecture is oriented towards its surroundings is a precondition for the ability of inhabitants to orient themselves within its spaces – whether of a building or of a city. To this end, they must have the ability to form a picture of the > spatial structure as a whole. As a rule, this occurs through the production of a cognitive or mental map; and moreover in two different ways. Either one imagines the space as a more or less complete structure; or, since the ground plan is not immediately perceptible, the positioning of spaces is conceptualized alternatively as a linear sequence of movements or actions between individual stations. Our living space is oriented towards the object world, and exploits only certain structural features of a given space, allowing > memory to become stamped by them, for example features of access or accoutrements deemed essential for habitual activities. Specific movement sequences and > figures of movement are stored in memory and are called up for the sake of orientation, although they may not actually be re-enacted. As a consequence, the body ‘knows’ where a door or wall is, and how many steps are required to traverse a room.

Architectural design can facilitate orientation within the space of a building or a city, for instance, through incisive spatial > structures and > order, through vistas, > axes and > routes. Reoccurring schemata of spatial order allow us to

find our way in unfamiliar buildings. We might ask, however, whether the ideal spatial order is one that would reveal itself fully at the outset, or whether it ought instead to follow the > dramaturgy of an arc of tension by revealing itself only gradually.

The necessity of finding one's way in space is of existential importance; moreover, this necessity for orientation goes beyond concrete spatiality to encompass social space as well. An individual who enters a foreign town or home not only must choose the right way, but also the appropriate behaviour, must penetrate not just spatial configurations, but social ones as well – as registered in the structure and features of spaces. Alongside built structures, it is social structures that determine the appropriate orientation within a given situation. Patterns of spatial behaviour facilitate orientation.

Ornamentation

In addition to adorning architecture, ornamentation renders its essential structure visible in the first place – even before 'decoration', the primary meaning of the Latin word *ornare* is 'to equip'. Rejected by the Modernist movement of the early twentieth century as a superfluous obscuring of structural > readability or an instrument for imposing semantic access on (naked) truths, ornamentation has meanwhile reacquired its independent function of enriching and modulating perception.

In retrospect, it is clear that what the break of Modernism achieved in relation to ornamentation was mainly to set it free to accentuate architectural effects in ways that go beyond decorative tasks or symbolic allusions. Such functions were mentioned already by Karl Friedrich Schinkel in his essay 'The Members of Architecture': 'To delimit the whole or its parts, to finish or to complete, to isolate the individual element, to emphasize it more powerfully, in many instances, to articulate the broad masses, or to connect separate masses through girdling.' (1979, 83) To be sure, ornamentation can negate architectural structure, but when instead it clarifies

this structure, it becomes integrated with constructive > detail. Then, the elaboration of joints, seams and connections between constructive elements appears as not only a structural necessity, but also an opportunity to present the building through its continuous ornamental shaping to a mode of perception that is simultaneously structured and holistic.

Ornamentation, then, is also an appropriate instrument for rendering the architectural order of large-scale structures intelligible on a suitable scale for close-range areas. This function is served by ornamentation in particular in the tactile and haptic sense when it fascinates the gaze through its small-scale plasticity and high density, thereby offering a certain resistance to the rapid gliding of the eye. Having ornamental effects may also be the intrinsic structure or texture of materials, for example the grain of wood or natural stone, types of textile, or the facture of certain treatments. Independently of the material employed, however, an impression of > materiality can be evoked by the ornamentation itself, for example the soft warmth of a finely engraved object, when contrasted with the cold hardness suggested by a smooth surface (> synaesthesia). In contemporary architecture, special interest is focused on the depth effects of superimposed layers of ornamentation as boundary layers that play with the delimitation or dissolution of space, and with optical effects, including *moiré*.

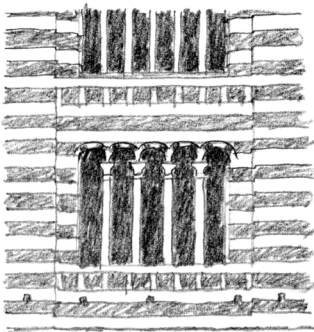

Ornamental features are often transferred to the object as a whole. Subtle facade ornamentation gives an entire building a fine quality, while coarse ornamentation gives it a rustic appearance. In their > directionality or rhythm, dynamic ornamental figures transmit their spatial gesture to the building as a whole. Ornamentation allows relationships as well as distinctions to be elaborated, and contours or transitions to be clarified that might otherwise be overlooked. Finally, it may render comprehensible the architectural structure of an entire > composition through the interplay of its parts, and even to generate contextual relationships on the scale of the city as a whole.

Just as architectural order and techniques of assembly have been given expression via ornamentation, more recently, it has been techniques of design and planning that have been reflected in ornamentation. Entire buildings and urban quarters appear like proliferating ornamentation, thereby betraying their conceptual provenance in digitalized design processes and parametric models.

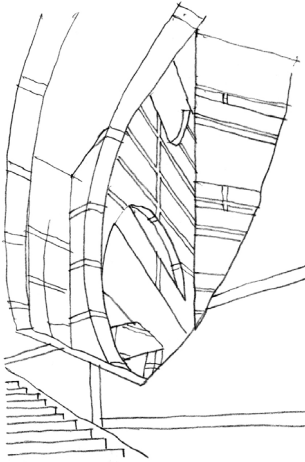

By recommending a particular distance depending upon the > scale involved, the ornamented built form establishes a concrete relationship with the beholder. The enlivening of architecture through ornamentation offers the stimulus of empathizing with it, and supports the appropriation and affective occupation of the built environment in everyday life. In opposition to commodity aesthetics, which continually renews ornamentation in order to render objects obsolescent and market new ones via the latest fashions, ornamentation should serve as the basis for an emotional > warmth and familiarity with one's immediate spatial surroundings. This contrasts with the demand for coldness of an 'experiential poverty' (Benjamin 1933/1999) through lack of ornamentation in modernity. Regardless, ornamentation contributes to spatial atmosphere and to the desired emotional character of a particular situation. Implicit in the related concept of decor, accordingly, is the ethical component of appropriateness; ever since antiquity, the Latin word *decorum* has referred to that which an object or individual requires in order to fulfil the task assigned and to express this in fitting fashion.

Literature: Gleiter 2002

Oscillation

In centred spaces, we are often exposed to curious, oscillating impulses towards movement. This > figure of movement, so characteristic of circular, oval or polygonal spaces, consists of a repeated change of position between centre and periphery. Once we have entered a centralized space, we are attracted sooner or later towards the centre, where we tend to occupy

a key position. There, we feel embraced by the spatial shell in an encompassing gesture, but also made to feel insecure. Whichever way we rotate or turn, and as a consequence of the forward and one-sided orientation of our bodily disposition, we find no stable position that allows us to grasp the space as a whole from the centre, in a way that would correspond to the dominant role of the centre in geometry. Because the continuous course of the wall extends laterally outside of our field of vision, we can follow it only through ceaseless bodily rotation. We can obtain a satisfying overview only when we adopt a position along the edge, from which point we are once again attracted towards the centre. When repeating this movement between the centre and various points along the periphery, we traverse the space in a singular oscillating pendulum or back-and-forth motion.

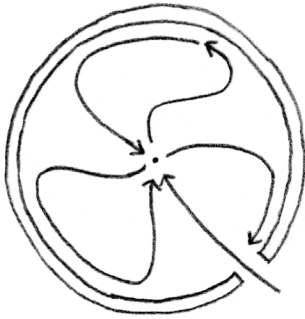

Outdoor space

> garden, ingress and exit, inside and outside, intermediate space, inversion, square and street, urban design view into/out of, window

Panel

> ceiling, closure, plane

Park

> garden, landscape, picturesque

Passage

> gallery, intermediate space, inversion, space-body continuum

Patina

Traces of use and of weathering provide eloquent testimony to the age of a building, its long use, and the influence of its environment. Patina renders the dimension of > time visible in architecture, and is one of the components with particular importance in generating specific > atmospheres.

The phenomenon of patina encompasses > surface changes through oxidation, the natural alteration of colour through darkening or fading, the accumulation of soil or smut, moss or lichen, and erosion, fissuring or flaking. When

deposits of dark material accumulate in depressions, while exposed surfaces become polished or bleached, the result is a characteristic light-dark contrast that asserts plasticity through height and depth.

Achieving expression in the process, first, are general characteristics of location or orientation. To the extent that individual areas are exposed to weathering, the differences between horizontal and vertical surfaces, between protected parts and weather-side, become visible. Second, the specific structural properties of the > materiality become clearly perceptible. With age, for example, the growth layers of soft woods become increasingly visible as relief in depth. Oxidizing metals, on the other hand, develop a specific coloration and form particular surface structures, rust being an example. Depending upon hardness and composition, natural stone erodes, is covered in moss, or becomes polished. Such changes render time perceptible through the perishable character of buildings; and buildings become capable of registering the passage of time.

Alongside effects of contrast, patina often has a communicative function. As the irruption of nature, it softens the artificiality of new surfaces through plant growth and other natural alterations, enlivening them and linking surfaces with one another, as well as with the surroundings, through unifying influences. A sense of familiarity with new housing estates is facilitated by the 'growing in' process that is fostered by progressing vegetation.

Patina also emerges as traces of > use. As a means of expression, it tells of consumer habits, for example through nicotine deposits. The nature and intensity of utilization becomes visible through polished door handles, worn steps, thresholds and threadbare floorings, just as wall areas formerly occupied by pictures are betrayed by their contrasting paleness. Such traces are among the enduring changes individuals leave behind on the surfaces of architecture. In the broadest sense, they include the more-or-less skilful repair of damaged areas,

which invest buildings and objects with personal character in the form of documentary collages or improvised bricolage. The appearance of genuine patina cannot simply be imitated artificially, but testifies as authentic traces to the dignity of natural use.

Patina is evaluated very differently depending upon the cultural context or object involved. While traces of age or use are sometimes regarded as blemishes in Western culture, Japanese culture accommodates a subtle aesthetic of patina, referred to with the term *wabi-sabi*. There, patina is prized as an inconspicuous, fractured or veiled > beauty. Objects are ennobled by the maturity and authority of the old, so that authentic traces of use increase their value. It is believed that a patinated object is incorporated more readily into a situation, and that, fusing with its surroundings, it generates the special aura of an atmosphere.

At times, an excess of patina can detract from the clarity of surfaces and contours, depriving forms of detail so that the effect of a spatial design loses its differentiation, interfering with essential aspects of architectural expression, for example, when facade vegetation masks the characteristic appearance of the building through a pronounced ‘coating’. The morbid charm that emanates from patina, which our sentimental yearning for the past makes us appreciate, can soon disintegrate into mere mustiness.

With a precedent in classical Modernism, with its denial of history, its preference for white buildings and an ‘absence of traces’ (Benjamin 1933/1999), many contemporary facade materials, including glass and painted, enamelled or anodized metal panelling, are designed to avoid allowing a surface character to alter through time. Regular facade cleanings make the buildings of all epochs come to resemble one another. Historic buildings too often seem faceless, appearing new, indifferently accessible to the present. Evidently, the layers of history can be washed off.

Literature: Koren 1995; Weston 2003

Pedestal	> ascent, base, entrance, facade, ground, ingress and exit, intermediate space
Penetration	> form character, transparency
Perception	> gaze, gestalt, odour, perspective, sensory perception, sound, virtuality
Performance	> architecture, figure of movement, gesture (spatial), gathering
Performative	> capacity, experience, figure of movement, gesture (spatial), scene, situation, urban design
Pergola	> arcade, garden, intermediate space
Peristyle	> arcade, centring, column, courtyard
Permanence	> architecture, event, monument, tectonics, time
Permeability	> accessibility and exclusivity, arcade, courtyard, intermediate space, intimation, facade, filter, porosity, transparency

Personal space

Every person is encircled by space, perceived as his or her own personal spatial sphere. In various ways, we are continually surrounded by such a spatial sphere. Martin Heidegger expressed this as follows: 'Just as I cannot jump over my own shadow, because it jumps forward ahead of me, I am unable to wander through the primary spatial environment within which I continually exist, because I carry it along with me constantly, slicing it, so to speak, out of the objective space of the world.' (1979, 221) The extension and form of this space are closely connected with sensory perception. It does not simply coincide with the visual field or with another sensory realm, but is also dependent upon various types of intentionality. The extension of this space and its orientation extends from the individual's immediate spatial requirements, all the way to the sphere of social space. These various ranges correspond, more or less, with built spatial delimitation.

In order to characterize the relationship between architectural space and the personal space of occupants, we must distinguish between various ranges or extensions of personal space: the purely physical demands made on a spatial volume can be described as its displacement by the human body and



the spatial requirements made by movements, which resemble, for example, the impression left behind in a plastic mass. Oskar Schlemmer's 'space lines' or the movement circles of Rudolf von Laban's 'Kinesphere' register the movement radii of the limbs as characteristic spatial figures. The required volume does not always extend all the way to the walls of the surrounding space (> interior). But the steps and forms of > staircases are like matrices for the body that ascends or descends; an armchair represents the negative form of the seated posture; and niches in walls or in furniture often resemble negative impressions of the space of reach. In perception, we begin by groping around a room via visual contact, anticipating possibilities for movement and storing this information in bodily movement.

That which we experience as our personal sphere, however, extends beyond the boundaries of our skin, reaching out beyond the limits of the body. We perceive our own clothing, for example, as belonging to our bodies (> body), and expand this periphery by means of prostheses or instruments, even the exterior of a car when driving. In perception, to begin with, our personal space extends as far as the reach of the senses. With its point of departure in the space of the body, it extends (> extension) all the way to objects towards which we turn, and is correspondingly extended and oriented in various directions. We not only extend the > gaze towards objects, but encompass them with our personal space, so that as Medard Boss has pointed out, 'not even the slightest perception of anything at all would be possible (...) were I not actually in contact, as the receiver, with the perceived object beforehand' (1975, 245).

Yet personal space exists for us independently of momentary perception, as an 'I-space' that is delimited from an 'around-space', as Karlfried von Dürckheim expressed this with reference to the home: 'In the home, we experience ourselves as being closed off in relation to the outside, and just as we are by ourselves when we are at home, whoever enters our

home, so to speak, enters us.' (2005, 93) Alongside the home or apartment, this I-space can extend to arbitrary portions of a building, or even its surroundings; I expand myself, for example, into the attic, or experience a new house erected by a neighbour as pressing in on me. The boundary between the 'I-space' and the 'around-space', then, is highly variable.

In a broader sense, one's personal living space encompasses those spaces which are of special significance in relation to personal life, for example one's workplace, the route leading towards it, and frequented locales in contrast to rarely visited areas of the city: 'A personal city emerges as a totality within which centres with which the individual has strong connections, spaces that are filled with personal experience, are distinguished from relatively indifferent ones.' (Dürckheim 2005, 97)

The social dimension of personal space has been characterized by cultural anthropology as a 'personal reaction bubble'. Proxemics investigates that which the individual perceives as his or her personal space in relation to others during social contact, and when its infringement is experienced as disturbing (Hall 1966). Its extension shifts according to one's interlocutor and the occasion, and is culturally determined. We distinguish between four different staggered spatial zones, which are configured concentrically around the individual, with increasingly greater extension; our intimate, personal, social and public spaces. These observations illuminate the rules according to which people establish themselves and co-exist with others in space, and explain why the density and spatial distribution of workplaces or restaurant tables, for example, are experienced as appropriate or invasive.

For each of the diverse types and dimensions of personal space, the design of architectural space may correspond to it more or less via > expansiveness and constriction, > directionality and > gesture.

Literature: Dürckheim 2005; Gosztonyi 1976; Hall 1966

Perspective

Perspectival perception offers us a double access to the spatial environment: a subjective view and an objective standard. The perspectivity of individual perceptions on the one hand, and the geometric guidelines of perspective representation on the other correspond to divergent definitions of the term, which however converge in perspectival perceptions of architecture. In perspectival vision, spatial situations are perceived as individual views, depending on the respective standpoint. This is taken into account by perspectival construction through projection from a visual focus. But at the same time, it overcomes any connection to the subjective gaze via generalization in terms of an objective norm. While the perspectivity of human perception assigns objects their spatial positions within non-homogeneous space according to the individual's angle of vision, mathematical perspective constructs a homogeneous space and orders everything within a rational geometric system; it is the 'objectification of the subjective' (Panofsky 1927/1991). The ways in which perspective is experienced architecturally oscillates between these two conceptions.

In contradistinction to the mode of vision that prevailed into the Middle Ages, and which concentrates on the building as an object or a body, the early modern period saw an emergence, together with the construction of perspective, of the idea of > space as a schema, as a scaffolding or stage, even before bodies appear on it. Since then, we have internalized the rational, standardized system of perspective, which dominates our culture all the way from painting to photography, from architecture to city planning, in such a way that it is inherent to our understanding of and feeling for space. But at the same time, this mode of spatial experience is perspectival in a different sense, as mentioned earlier, that of a dependence upon the individual disposition, momentary constitution, and bodily conditions of perception.

Converging in architecture is the objectivizing tendency of perspective with the perspectivity from a subjective angle of vision. For the subjective position, a view that is shaped

by a particular standpoint constitutes a typical precondition, one that is generated, for example, by guiding the > gaze by means of a constricting frame. As a prospect or perspective (Latin: *perspicere*, to look through), that through which the gaze passes, i.e. the > window (which also always blocks something from view), converts what it frames into a picture, with the glass pane materialized as a picture plane. As a side effect of this heightening of meaning, its pictorial character may make this prospect appear > picturesque, but hence also un-architectural. With the centring of the direction of the gaze by a frame or through the beholder's position, for example along a spatial axis, the central-perspectival impact of staggering in depth and the convergence of the lines of sight become noticeable as a kind of pull into > depth. Such effects are supported by structural elements or colour perspective (> colour). This convergence is heightened through tiered funnel forms, which cause the transitional space of a portal to seem extended in depth, for example, thereby lengthening and delaying its traversal via perspectival means. The trapezoidal shape of a forecourt that widens out towards the facade has the reverse effect. Perspectival effects, then, can be deployed in subtle ways, or in extreme cases, for the sake of extreme forms of optical deception. In certain spatial situations, for example the Baroque plans of towns or squares, perspective emerges as dominant, assigning the beholder his or her place, to perceive and interpret the architecture from a specific point of view, and in accordance with a preconceived intention. With such objectives, schemas of this kind were consistently used for the architecture of authority, for absolutist and authoritarian planning.

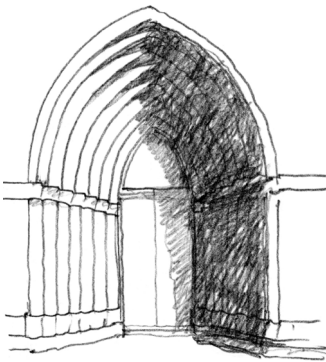

Ever since the perspectival centring of the gaze and the thought has lost its binding force, i.e. because cultural and social changes were accompanied by an altered understanding of space, the forms of spatial experience in architecture have changed as well. Convergence and frontality are circumvented when the skewed positioning of buildings and walls

divert the gaze. The frame of the delimited vista is exploded, the image plane is broken open, as continuous wall slabs blur distinctions between interior and exterior, and the panorama window is dilated so far laterally that the edges responsible for framing views vanish from the field of vision. The perspectival effects of architecture no longer bind the beholder through targeted positioning and by focusing the gaze; such bonds have become loosened.

Stepping into the foreground instead is the perspective's other role, namely its systemic function, i.e. its provision of neutral scaffolding for the visibility of space and for the establishment of order within it. In this respect, incidentally, it resembles other types of projects, such as axonometry. Originally, the constructive lines and axes of perspective facilitate the structure of graphic depiction, but they are also materialized in the ordering grid of architectural structure, for example in the modern skeleton frame structure, so to speak as the isotropic spatial grid of a homogeneous coordinate space. In such – in principle – homogeneous spaces, to be sure, the perspectival gaze still emanates from a visual focus, but its position and orientation are nonetheless arbitrary. While the primarily subject-determined perspective in architecture was constructed in such a way that it accentuated important alignments, centres, visual goals, framed views, and vistas, objectivized perspective, as the perception of a 'homogeneous but fragmented space' (Lefèbvre 1977), proffers exchangeable components of views and images to the gaze. If in the first conception, everything depends upon the standpoint, then this becomes arbitrary in the context of its counterpart. Compared with subjective perspective, it almost seems aperspectival, or better: multiperspectival.

In fact, a full perception of architecture occurs only through a complex of changing – but not arbitrary – angles of vision. Elmar Holenstein (1985) has pointed out that the origin of ego-centredness need not coincide with the body, nor with the eye-position of perceptual perspective. This does not

mean, however, that we experience space from an arbitrary assortment of interchangeable angles of vision. Instead, the various systems that are present in space have their own centres, into which we enter through the imagination, without occupying them in reality.

As the goal of our wandering attention and orientation, it forms a changeable focus. Emerging from it is the perspective from which, in turn, we experience our own bodies (> body, human).

Literature: Holenstein 1985; Pahl 1963; Panofsky 1927/1991

Physiognomy

> facade, form character, roof

Picturesque

Architecture can be considered either architecturally or in scenic or picturesque terms. A work of architecture must not necessarily be regarded architecturally. Dagobert Frey has remarked that, 'in many cases, the layman tends more strongly towards a picturesque outlook, that he seeks out and favours contingent groupings and overlapping, pictorial details, the 'picturesque angle'.' (1925/1946, 99) Painting is distinguished from architecture through its presentation of a self-enclosed, ideational aesthetic reality; as beholders, we do not participate in a painting the way we do in architectural reality, but instead confront it as a spectator. Our picturesque perspective of architecture, then, tends to suspend the architectural point of view, so that we approach a building in a distanced way like a planar > image. This illusionistic point of view, which reduces reality, is offered in particular by a camera viewfinder, which is tied to a fixed standpoint, and is not supplemented by physical movement through an actual space.



In picturesque perceptions of architecture, we are charmed by traits that resemble those that are familiar and valued in the realm of painting. Differently from a realistic depiction executed in the medium of drawing, a painting gen-

erates dynamic colour relationships. As a consequence, we expect picturesque architecture to offer a pictorially composed dynamism, colour, contrasts of light and shadow, diversity and irregularity – and at the same time, an impression of cohesion and coherence. The picturesque is precisely the deliberately created and apparently unintentional aspect of a situation, the apparently fortuitous convergence of magnitudes, directions and colours, which nonetheless stand in a recognizable relationship of equilibrium with one another. Our understanding of picturesque architecture rests upon themes that were developed throughout history, particularly in the eighteenth century and in Romanticism. In the meantime, the nostalgic and culturally critical cultivation of a supposedly natural, albeit composed disorder, of the apparently original, the authentic, has become questionable, even coming under suspicion of being infected by kitsch. Taking its place in some instances, meanwhile, is a poetry of fashionable brittleness that extends all the way to a picturesque image of wretchedness, a kind of dirty realism that is itself hardly secure from the danger of sliding into kitsch.

The painterly conception holds architecture at a distance, freeing the beholder from the physical constraint of its unmediated spatial presence and allowing him or her, according to August Schmarsow, to work out the ‘unity of body and space in the surface of a distant image’ intellectually in a state of ‘tranquil contemplation’. Reduced to an individual > perspective, the spatial reality becomes the object of a primarily aesthetic form of pleasure.

Despite the non-architectural character of this restricted point of view, picturesque architectural compositions and cityscapes, with their aesthetic condensation of spatial superpositions, vistas and colour relationships, are often an enrichment of architectural experience. Spatial depth does not so much impel physical movement as it serves a tension-filled visual composition in a tableau of overlapping forms and contrasts of directionality. Even during physical movement, picturesque

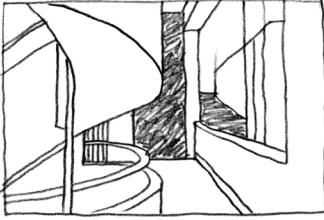

partial images alternate in a kaleidoscopic fashion, forming sequence as though in a film. The attractiveness of a picturesque cityscape is not only an expression of a backward-looking nostalgia that is oriented towards medieval instances of quasi-naturally developed localities and urban structures. The irregularity of curved rather than rectilinear street layouts is also a timeless resource for shaping urbanistic spaces. In contrast to streets that plunge in rectilinear fashion into endless depths, the offset alignment of street fronts and horizontal or vertical shifts of direction that interrupt view axes are a resource for closing off the spaces of > public squares and streets, but also for maintaining them as planar images. Landscape architecture as well stands in an explicit relationship to landscape painting. The English landscape garden in particular was designed to allow visitors to stroll through an ideal image. In the form of an artificially constructed image, a putatively undisturbed nature is translated into a > landscape that is perceptible from multiple points of view like a composed landscape painting, and framed for example by the entrance to a grotto or the wooded edge of a clearing. As the visitor strolls through the park, a montage of individual images appears in succession, interrupted by passages devoid of images, forming a picturesque sequence.

Literature: Frey 1925/1946; Schmarsow 1897

Pillar

> arcade, base, column, density (spatial), hall

Place

Even architecture that is conceived primarily in processual terms comes about at a location, through which it is not only localized, but also situated and conditioned within an all-embracing context. To be sure, a place can be determined by marking a specific location on the Earth's surface, but it cannot be experienced by defining it in purely geometrical terms. A place acquires an identity that can be experienced

practically through its attachment to a distinctive texture of characteristic historical, landscape and architectural features, one that is also reflected in the spaces of a locality. Marc Augé (2009) distinguishes such ‘places’, characterized by this type of identity, from the interchangeable ‘spaces’ of the consumer world, examples being airport terminals and supermarkets, which he therefore refers to as ‘non-places’. According to Michel de Certeau (2011), however, ‘spaces’ can be grasped as forms of concrete handling of individual ‘places’.

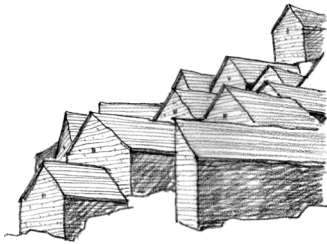

The unmistakable character of a place is noticeable immediately on an intuitive basis as its ‘spirit’. Its *genius loci* – a term which originally referred to a Roman tutelary spirit of a specific place or house – can also mean its particular local identifying features, the formation of the landscape, its shaping by the topography, bodies of water, vegetation, local customary building forms and materials, and a specific relationship between development and infrastructure, along with typical local climate and regional weather conditions and a characteristic type of natural light. Even odours and sounds mark out a place, enabling it to be identified. Places, moreover, embody cultural memory. A place that has been occupied over an extended period of > time is an accumulation of history, of stories, of local myths and cultures, of historical and cultural events, but also of everyday life. The sum of experiences of the place, finally, are bundled together into its > atmosphere, which is often palpable in the customs, forms of life, and mentality of the inhabitants. The term *genius loci* gives expression to the constitution and character of the place, which can be analysed into individual effective components only at the cost of losing its identity as a whole.

Architecture is capable of condensing and bringing to expression the natural and artificial characteristics of a place, allowing them to become experienced in sensory terms. In buildings, it ‘gathers together’ the idiosyncrasies of a place, as Martin Heidegger said, his illustration being a celebrated description of a bridge: ‘It brings stream and bank and land

into each other's neighbourhood. The bridge gathers the earth as landscape around the stream.' (1953/2008, 150)

Through the empathetic taking up of specific traits of a place into an architectural > concept, its character becomes more vivid, i.e. by being concentrated, clarified and supplemented. An architectural concept – regardless of whether it concerns a > landscape, > town planning, or house – may be derived almost entirely from the articulation of specific local features. This may involve the sensitive further development and accentuation of landscape formations and topographical idiosyncrasies, the alignment along pre-existing built elements, the establishment of connections to existing routes, and the linking of interior spaces and their utilizations to their respective exteriors. A structural layout interprets the genius loci in a commensurate way not solely by incorporating and adopting measures, forms and materials, but also when it allows local structures to become more conspicuous through the introduction of contrasts. One element that is powerfully expressive when it comes to manifesting its relationship to the local context is the roof; it takes up alignments, reaches into the space, establishes connections, fuses with the surroundings, or sets accents. In the form of a roofscape, it combines with other groups to echo the surrounding landscape, exaggerating aspects of the topography; it can also respond meaningfully to the form of the local territory, however, through a countermovement.

A prominent positioning with broad views, of the kind offered by the summit of a hill, becomes an incisive experience within a locality, one that crowns the summit. The concave enclosure of a bay is experienced structurally like a type of amphitheatre, or the tribune character of a sloping landscape through terracing. A house like the Casa Malaparte on Capri, which emerges from the cliffs, allows one to live on or in the rock formation. As a threshold building, Erwin Heerich's Lange Galerie in Hombroich stages a delayed entrance to the island. Through its spatial reaction to an urban

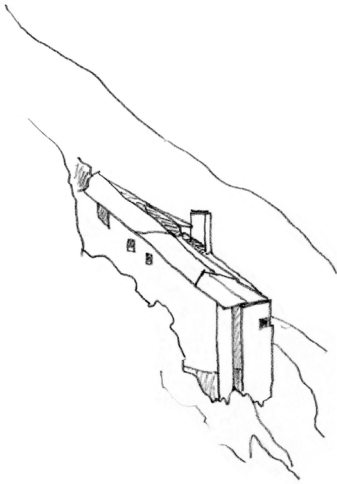

structure, in contrast, public squares or buildings create inner focal points or enter into dialogue with prominent counterparts, an instance of this being Rafael Moneo's Town Hall in Murcia in relation to the cathedral.

A conscious or intuitive picture of our current position in relation to place is the basis for our > orientation in space; it is continuously modified and updated during movement. A sense of uncertainty about where one is produces feelings of general insecurity, while the architectural articulation of the identity of the place guarantees recognizability. Even a lifestyle that is characterized by mobility requires local anchoring points. For those who remain somewhere for a long time, conversely, a place's architectural reshaping contributes to the familiarity that is the foundation for a personal spatial development. The extreme of a spatial and life praxis that is interested only in ephemeral happenings is opposed by a yearning for *stabilitas loci*, for life processes that are safeguarded, or even given an enhanced significance, through a sense of stability in relation to place.

Literature: Augé 2009; Bloomer/Moore 1977; Norberg-Schulz 1991; Valena 1994

Plane

Through the forces of gravity, our movements are tied to the horizontal plane of the floor (> ground) and screened upwards by the parallel plane of the > ceiling. As corresponding planes, floor and ceiling, ground and roof, form an intervening space for movement that is interrupted by the vertical planes of the walls. A spatiality organized primarily by means of planes that slice into space and expose it, rather than enclosing and shutting it out, contrasts with the clear framing of a straightforward container. Herman Hertzberger (2000) claims that in the first instance, the room remains intact, and is in fact generated, while in the second, it is used or consumed.

Houses can be assembled entirely of plane surfaces, of (horizontal) panels and (vertical) slabs. The walls, in turn,

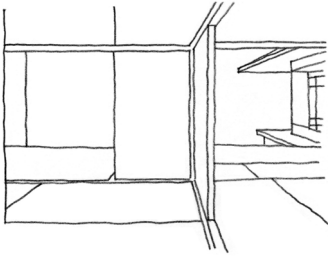

may be disassembled into a > layering of levels. Such houses seem light and ephemeral, an example being the traditional Japanese house, with its individual wall planes, the floor plane, which is detached from the ground, and its movable sliding walls. If floor, walls and ceiling as pure (coloured) planar elements converge at the corners or never meet at all, as in the buildings by the De Stijl architects, then the house resembles a demonstration of compositional possibilities, while tending towards a certain abstractness. Strictly speaking, however, the individual wall slabs and ceiling panels are not two-dimensional surfaces, but also > bodies. By entering into relationships with one another through the planes of their surfaces, for example through > angles or > confrontations, they articulate the room; at the same time, as individual planar elements that are distributed in space, they maintain the flow of movement through guiding and leading effects.

A special role is played by the floor plane. In outdoor spaces, where vertical planes are absent, contrasts in floor level articulated via steps are a means of dividing the space. In order to effect spatial extensions into height, and at the cost of contact with the ground, buildings require a multiplication of levels through the stacking of storeys. Intermediate levels coming between full storey heights allow gradual transitions, connected lines of sight, and contact between upper and lower (> Raumplan). Likewise, staircases, platforms or individual steps effect a segmentation into smaller entrance levels. Inclined planes represent an intermediate form. Through a barely perceptible gradient, one is induced to move downward, albeit without really knowing why. A more pronounced declivity, however, makes it difficult to stand, and is therefore hardly conducive to lingering, or else it invites us to squat down, i.e. at the Rolex Learning Center by SANAA in Lausanne.

General meanings are associated with various levels. The attainment of an upper level, for example, gives one a sense of leaving obstacles behind (> ascent), a rise in living standards,

intensification, synoptic views, and power, while in a dusty lower level, one remains tied to the earth, subordinated. The social code according to which the distinction between upper and lower levels expresses social hierarchy is not necessarily true for architecture. Nonetheless, the superimposed zones of residence in a city are divided into the ground level (*parterre*), generally somewhat darker, whose mode of ingress and exit links it to the surroundings, and associated with provisioning and trade, and a more withdrawn residential level – referred to historically as the *bel étage* or *piano dei nobili* – which is associated with refined living. The uppermost level, with its proximity to sky and air, offers views and connections to distant points, or serves as a roof terrace. Each level serves as a basis for the adequate unfolding of activities.

Plasticity

> body (architectural), facade, ground, light, roof, sensory perception, surface

Playing field

> field, ground, roaming

Poché

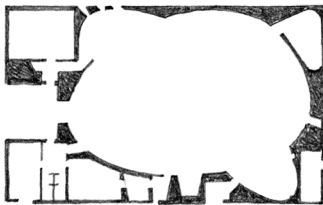

Thick, often irregular forms and wall masses through which spaces appear wrapped up and cushioned, as though by an upholstered bag (French: *poché*), are also referred to in English as *poché*. Such padding occurs in particular when the rooms of a plan fail to ‘add up’ because individual interior spaces differ from one another to such an extent that the divisions between them cannot consist of simple wall slabs. Where the rooms adjoin, the remaining, irregular areas are therefore evened out by *poché*.

In French, the word *poché* originally referred to the blackened or hatched areas of the sliced-through areas of a plan or cross-section. Recognizable in a figure-ground plan in particular (but only to a limited degree in concrete situations) in the figure/ground relationship between architectural > body and space is the way in which *poché* assigns a figural

function to the empty space. Solid masses remain subordinate, in the background, and support the form of the space. The individual room tends to appear separate from the others and from the larger plan, since interrelationships between rooms are disrupted by discontinuities of spatial geometry or unexpected changes of alignment, and the areas between them only patched together in a formless way by *poché*. As a consequence, the utilization of the *poché* makes possible the free disposition of interior rooms with regard to shape, alignment and arrangement, yet without necessarily influencing adjacent rooms with regard to position or form. It becomes possible, for example, to shape > concavities by modelling wall masses in adjacent rooms on both sides of an adjoining wall. The deployment of *poché* strengthens the presence of the individual room in relation to the unity of the overarching spatial structure. *Poché* can be regarded as a continuous background, a kind of supporting tissue through which individual rooms are packed together and connected, yet guaranteed independence and *Prägnanz*. Within a complex spatial system, it makes cohesion possible between diverse forms and alignments. Through the modelling of the mass of the facade, the *poché* enables mediation between interior and exterior space. As a consequence, this zone of interference is also a resource for creating balance, one that allows responses on each side in a differentiated way without any requirement to establish correspondences between inner and outer contours, as would be necessitated by uniform wall thicknesses.

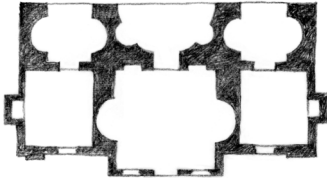

The wall masses formed by *poché* generally appear as irregular remainders, as secondary, negative imprints in relation to the primary spatial forms. Yet perception is capable of inverting this relationship so that mass becomes figure, an example being the pillars of Donato Bramante's plan for St Peter's. *Poché* is for the most part effective in plan, but can play a role in section as well, in particular as intermediate zones between > ceiling and > roof. Through > porosity or > space-containing walls, architectural masses that function

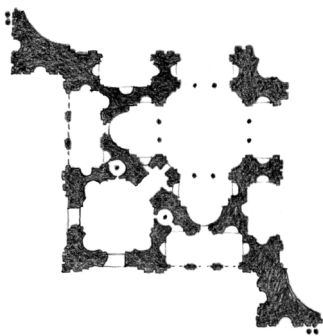

as poché may in turn contain interior spaces which remain in the background in relation to the main rooms as subsidiary chambers, ancillary rooms, cabinets etc. On the scale of the town as a whole, entire buildings or even blocks of buildings can be conceived as inhabited poché.

Literature: Hoesli 1997; Rowe/Koetter 1978

Pole

> axis

Porosity

At times, the space-delimiting, structural masses of the building are so perforated and filled with hollow spaces that the whole makes a yielding, porous impression. In general, a material is referred to as porous when its mass is continuously perforated by a multiplicity of small air chambers. By analogy, porosity can be identified as an architectural trait on various scales, i.e. when a building or its individual parts are not solid, smooth or impenetrable in appearance, but densely interspersed with numerous small hollow spaces or by grooves or fissures.

Such porosity presents no decisive resistance to the tendency of our personal sphere to expand or to force its way outward, but instead responds with openness and permeability. It does not restrict our spatial field of play with hard boundaries, but gives us the feeling of following the infiltrating gaze, of penetrating physically into various forms and > depths.

In essence, > space-containing walls offer this kind of leeway for expansion by cushioning spatial limitations by means of > resonating and > intermediate spaces. On the scale of the town as well, a development with small-scale segmentation and a high level of permeability can be characterized as porous. As a rule, however, porosity pertains to the smaller scale. Although the chambers created by the niches, alcoves and cabinets are relatively large ‘pores’, in dense arrange-

ments they are capable of dissolving buildings or walls into a permeable structure. Moreover, they offer a multiplicity of options for entering, abiding, concealment and withdrawal. Porosity becomes more explicit in the finer grain of shelving, storage compartments, and open fixtures. When wall divisions are effected as a dense texture of slits, joints and small apertures, the gaze may get lost in them.

On the scale of surface structure and > materiality, fibrous wood, porous stone, coarse meshwork, and textiles are typical examples – even the thick Japanese paper of shoji screens has a soft porosity. The continuous ornamentation and sculpting can create the impression that a solid mass of a surface is disintegrating, examples being the stucco embellishments of the Rococo, Plateresque ornamentation in Spain, or the sculptural dissolution of structural elements in Hindu temples. In special instances, such as the finely sculptured alabaster columns in the Adinath Temple of Ranakpur, the plastic structure creates an impression of porosity; the pores are also open towards the light from various sides. With a capillary ramification into the smallest caverns, they seem to capture the light and the gaze. Like a sponge, they manifest a permeability that loses itself somewhere in the depths of the mass or of the space.

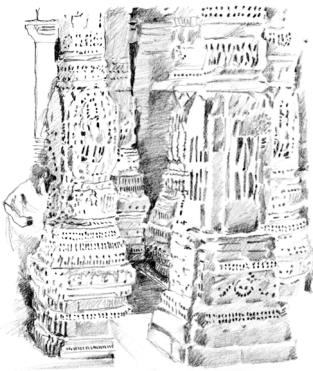

Portico

> arcade, column, door and gate, facade, hall, ingress and exit

Postures

Standing (1), sitting (2) and reclining (3) are the most common poses suggested to us by buildings as spatial settings. In their > form character, they seem at times to adopt such postures themselves.

1. Standing requires the resistance of the > ground; the horizontal > plane makes a stable standpoint possible. Our feet create a broadened base that corresponds to the foundation and the > base in architecture. Uneven ground, on the

other hand, makes standing difficult or even impossible. The dynamic effect of a slanted ground plane comes about because it endangers the statics of the upright posture. We experience the erection and upright position of a building as a gesture that corresponds to the placement and standing posture of our upright bodies. Walls and > columns, supports, pillars and > towers stand on the ground, rising vertically, thereby functioning as direct counterparts to the standing human figure. At times, this correspondence is clarified by anthropomorphic forms (caryatids, atlantes) or by an analogous articulation (foot, rump, head).

In many cases, the > gestures of entire spatial forms suggest an erect, standing posture, for example a tall space such as a cupola above the transept of a church, or a high, pointed-arch vault, while in contrast, broad, low, squat spatial forms seem to counteract an erect posture. While the scale of the standing and walking human figure determines the format of the door, the window must – if it is to provide us with views to the outside – be oriented simultaneously towards the eye level of a standing individual as well as a seated one.

Since a standing posture – in contrast to a seated one – may change to movement at any moment, such a posture facilitates an active relation to space and objects. A standing posture also makes it possible to imagine being present at remote places despite spatial distance. The standing posture, then, represents a form of ‘rest in movement’ (Valena 1994), one that continually seeks out a stable future standpoint on the basis of an anticipatory gaze.

2. To be seated is to take up an enduring and fixed position within a space. Just as a standing posture also involves movement in space, being seated in a room requires a decision concerning the preferred location. This requires the position facing a wall, window or light source, an overview of the room, and the connection between seat and table to be optimized, often after various positions have been tested in order to establish the ideal one. Restricted in movement, yet

nonetheless active, a seated posture often provides relief from continuous activity, or allows rest after walking and standing.

Comfortable sitting in our culture requires an item of furniture such as a bench, chair or armchair (> furnishing). More strongly than other architectural elements and furniture forms, it is the chair that embodies the figure of this posture. As an angled form with installed back piece, it is the image or counterform of the seated posture. When arms or headrests are added, it mirrors the seated figure of the human individual in a complete way. To sit in a chair takes precedence in our culture, but worldwide, it is encountered far less frequently than sitting on the floor with crossed legs. This pose connects the sitter directly with the ground. In place of the table, the entire surface of the floor now serves as an area of action. To sit together on the continuous plane of the ground fosters a special social proximity and flexibility in the choice of seat. In our culture as well, there have been attempts to rehabilitate the spontaneous form of seated spatial experience; these culminated in the design of living rooms as a 'seating landscape'.

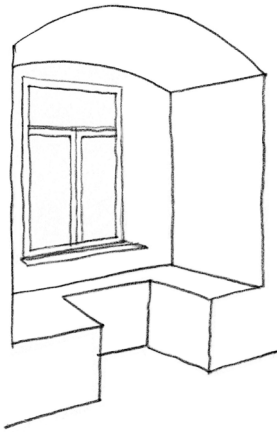

There are small architectural spatial units whose characteristic experiential qualities emerge substantially from the posture of sitting. These include window niches into which benches have been built, so that one sits directly within the wall or window and looks directly onto the boundary line of the screening element into the room within or else out of the > window. The prayer stool or medieval 'cabinet' (of St Jerome) are other forms through which a seating arrangement gives rise to a space within a space (> incorporation). Without generating a specific architectural form, many spaces are influenced in essential ways by sitting habits or seating, often with a table as a corresponding plane of action. Through the height of the balustrade, the window seat in an interior takes the seated posture into consideration. Restaurants and cafés are shaped by the arrangement and sizes of tables and chairs. In conference rooms, theatres and cinemas, seating arrange-

ments establish specific relationships of hierarchy between listeners or spectators on one side, and speaker podiums, stages and projection screens on the other. The audience sits in rows that are oriented exclusively towards the stage, thereby subjected to a pronounced > directionality. Through their alignments, certain seating arrangements, for example those of choir stalls or of the British House of Commons, generate fundamentally different postures or attitudes, i.e. of facing each other, or opposition. Regarded historically, a seated posture was considered a privileged one. At an official ceremony, a dignitary sits on a special chair, a throne, which clarifies his or her status. A subaltern, in contrast, stands or kneels in front of the seated dignitary.

3. A recumbent posture involves resting in a reclining position with all of one's weight in one place and on the surface: a town, a lake or a parcel of land are said to 'lie' at a specific location. For human beings, reclining is the most pronounced form of immobility, and at the same time the most comfortable and stable posture, one that allows all of our muscles to be fully relaxed. It is a preferred position of rest for sleeping, resting, reflecting, convalescing, and finally for burial after death.

The individual who reclines withdraws into himself, experiencing a singular sense of introversion in this posture. When reclining, one's > personal space has a different extension compared to other postures. The visual field is different as well. When we lie on our backs, our architectural counterpart suddenly becomes the ceiling or the sky, which otherwise received little attention. Both the accessibility of objects and the physical effort necessary to obtain them are altered, and our thoughts become remote from our actual surroundings as well – the world grows smaller. An individual who lies in bed 'exists in a space that differs from that of someone who moves in an upright posture.' (Bollnow 1963, 173)

When reclining, our bodies feel the floor or other support directly; we become conscious of our entire physical weight,

or have the feeling of fusing, of merging together with the plane upon which we lie.

There are spaces which stage recumbence, so to speak, endow it with special architectural weight, i.e. by differentiating the space for reclining as a berth or roofed room within a room, examples being alcove or canopy beds. Surrounding the sleeper in such instances is an additional protective space that fosters an intensive interiority, and in some cases even a private ceiling bearing a painted sky.

Literature: Bollnow 1963; Eickhoff 1993

Prägnanz	> capacity, gestalt, monument, space-body continuum, type
Pressure	> body (human), density (spatial), expansiveness and constriction, field, force field, movement, structure, tectonics
Privacy	> accessibility and exclusivity, cell, facade, inside and outside, residence, screening, territory, view into/out of
Private area	> accessibility and exclusivity, apartment, cell, furnishing, spatial structure, territory
Process	> ascent, capacity, event, movement, order, ritual, situation, time
Projection	> furnishing, interior, perspective, space-containing wall, space shadow, wall, window
Promenade architecturale	> movement, sequence
Proportion	‘Architecture is the art of proportion.’ By this, Bruno Taut (1977) meant that all > architecture must rest upon a well-thought out, coherent structure. For Taut, it was decisive that every building display the correct interrelation of all parts, the appropriate relationship between content and form, and the relationship between the building and its prerequisites, including climate, budget and the people who would use it. Viewed in this way, the architectural in a highly general – and not necessarily spatial – sense would be proportionality, the logos. That is why Donald Judd speaks of ‘reason made visible’.

Customarily, however, proportion in architecture has been understood in the narrower sense as scalar relations between the parts, and in relation to the whole, which assumes that the whole is regarded as being fitted or pieced together. The term *proportion* must be distinguished from *scale*, which concerns the dimensions of a building in relation to something else, for example, to a neighbouring building, to the human figure, or to certain norms. Proportions convey expressive values, and can be optimized so that they offer the intellect a satisfying clarity and endow a building with a harmonious order.

Given their dependence upon precision of tonal relationships, the notions of harmony current since antiquity, with their basis in musical intervals and their anchoring in the cosmic order, however, do not seem transferable to the visual realm of architecture. Also controversial is the translation of the dimensions of the human body to those of architecture, as found Le Corbusier's Modulor system.

Simple whole-number relationships between the sides of a rectangle, however, are generally easily recognizable by the eye, and are graspable mentally. Proportion, 'is thought and feeling undivided (...) 1 to 2 is just as particular, is – not 'has' – as much its own quality, as red, or red and black', says Donald Judd (1989, 177). An oblique perspective does not alter the impact of proportion; we identify a rectangle as such even from a distorted perspective.

Surface areas, the lengths and breadths of structural parts, wall areas, and the contours of buildings, were for the most part referred to traditionally as dimensions, from whose relationships proportion is known. Indirectly, to be sure, these endow the proportions of entire rooms with a dimensional order; to experience the space, however, the dimensional relationships of the third spatial axis are decisive. Our feeling for space is taken into consideration only when length and breadth enter into a relationship with height – for which Andrea Palladio chose the mean value between length and

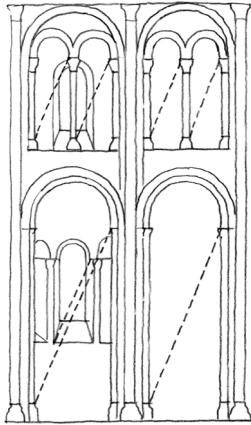

breadth. Only when dimensional relationships are transferred from surface geometry to the geometry of structural masses and spatial volumes do the relationships of measures/dimensions between buildings, interiors and urban space become controllable. This is ensured in particular by the reciprocal dimensional relation of a deep space-containing facade towards > inside and outside. Independently of the value of the individual proportions, rectangles of identical proportions are perceived as being similar. Proportionality, then, also means that a basic form is repeated throughout a building so that the individual parts of a building are similar in form and arrangement, or recapitulate its principal figure on a smaller scale. 'Harmony in architecture is precisely the analogy of part to whole, to speak with Vitruvius.' (Thiersch 1926, 116) Through such formal affinities, or similar ones, a formal order is directly perceived as consistent.

The perception of proportion, then, is regarded as a rational component of spatial experience, as a primary means through which building and spatial forms are grasped intellectually. Proportions are experienced not solely through an analytical evaluation of relative dimensions, but also as an unmediated expression of form. It is, however, not only 'good' proportions that are achievable through appropriate dimensional relationships, but also a dynamic of the > form character, and a specific > gesture, which in turn contributes to the > atmosphere of a situation. Some dimensional relationships of building parts, including walls and floor areas and spatial volumes, express tranquil compactness, while others suggest vertical or horizontal movement. Theodor Fischer assigned proportions to specific emotional expressive values; he described reclining formats, depending upon their dimensional ratios, as humble, comfortable or tranquil, and vertical formats as strong, proud or exuberant.

Literature: Boudon 1991; Van der Laan 1983; Naredi-Rainer 1982

Proprioception	> haptic qualities, movement, orientation, sensory perception
Prospect	> ascent, stairs, tower, view into/out of, window
Protection	> accessibility and exclusivity, comfortableness, dwelling, interior, residence, warmth and cold
Proxemics	> expansiveness and constriction, force field, measure, personal space
Proximity	> column, complexity, expansiveness and constriction, facade, gaze, scale
Public/Publicness	> accessibility and exclusivity arcade, facade, hall, inside and outside, screening, residence, urban design, view into/out of
Purpose	> use
Quarter	> structure, territory, urban design
Radiality	> centring, form character, gathering, spatial structure, square and street, type
Radiance	> form character, force field, space shadow
Ramp	> ascent, stairs

Raumplan

As formulated by Adolf Loos, the concept of the Raumplan deals with subdivision of architectural space in elevation. Our bodies do not allow us to rise from the surface of the ground/floor, but the Raumplan initiates a free play in height. Said Loos: 'That is the great revolution in architecture: to solve the plan in space! Prior to Immanuel Kant, people could not yet think in space, and architects were compelled to make a bathroom as high as a hall. (...) And just as when they succeed in playing chess in three dimensions, architects will also learn to solve the plan in space.' (Rukschcio/Schachel 1982, 31)

Loos lamented the fact that most architects persisted in emphasizing the plan in their designs, in layering simple > levels one above the next. In his designs, he developed a virtuoso and differentiated play with leaps of level between

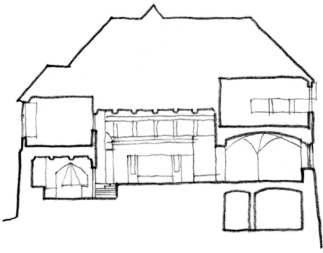

individual rooms, which were either raised or lowered and reached by small numbers of steps rather than conventionally through level transitions. This resulted in more complex > spatial structures and a multitude of new perspectives between individual rooms. Levels that are staggered in relation to one another allow a nuanced coordination of division and connection.

To fine-tune a room in relation to length and breadth in such a way that its proportions are optimized for its respective purpose and intended effect would mean that its height could be chosen accordingly in relation to the given surface area. This is impossible, however, if ceilings are continuous in each storey. If one allows the ceilings to leap in height from room to room, then a refined interleaving – which assigns each room its optimal height – allows the total external volume to be utilized optimally.

In principle, a > gallery allows spaces to be linked vertically. The activation of space in all directions can be carried even further where spatial units and links between them are distributed freely in a large volume, as in the design by OMA for the Bibliothèque de France.

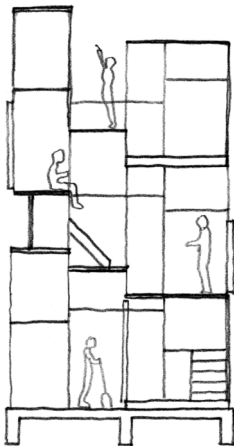

Through the Raumplan, it becomes possible to seek out optional positions in space, moving not only on the surface, but in three dimensions as well. A decisive role is necessarily played by steps and > staircases. When they are not accommodated in external and inhospitable staircases that link storeys, but instead integrated along the edges of inhabited spaces and subdivided into short sections that shift in direction respective to one another, the casual act of > ascent becomes a varied spatial experience rather than a burden. Larger staircase landings are well suited to pausing and for taking in views. Where landings also provide access to various room levels, transitions between rooms are simultaneously shifts between elevations. In principle, such varied staircase configurations and stratification of levels makes it possible to ascend in all directions within a house that, seen from the outside, is quite

simple and clearly structured (i.e. as a cube). A well-calculated > scenic direction opens up dramaturgical possibilities that are reminiscent of the spatial fantasy in the carceri of Giovanni Battista Piranesi.

Literature: Kulka 1931

Readability

On the one hand, architecture is read like a text; on the other, like a human face. In the first instance, structural forms or entire buildings assume the function of > signs, which one learns to read, generally in reliance on cultural codes. A reading mediated by signs, however, encompasses only a marginal fraction of architectural communication. For the most part, architecture conveys meaning via immediately and intuitively accessible forms of > expression, whose impact on us is direct in nature.

When architecture is read like a text, it is capable of conveying inherent contents or narrating stories, of gratifying the intellect through its lucid intelligibility, or of engaging in play with divergent readings. It is always a question of legibility, of the quality that allows us to identify certain contents or structural forms through relevant interpretive acts or readings, thereby allowing us rationally to comprehend a spatial structure or constructive principle, a set of dimensions or a system of access. According to functionalist maxims, a building's function in particular ought to be legible through its form; practical > utility should find expression in a form that is expressive of use. Also found among the functions of architecture, however, are cultural and political meanings whose legibility follows their own rules for reading. Alongside a building's inherent features, its structure may also allow a reading of its position within the superordinate context of a landscape or cityscape, which may itself in turn be readable as a text (> context).

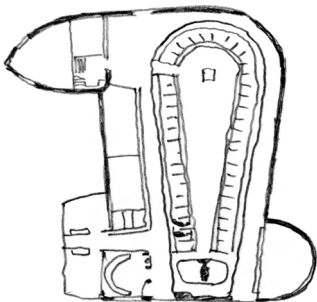

On the one hand, readability is an indispensable precondition for the intelligibility of architecture, and its rational

transparency is the basis for the intellectual pleasure that accompanies the deciphering of an architectural > composition. Revealed as illusory, on the other hand, is the ideal of satisfaction via forms that are held to be totally transparent in relation to their contents, as demanded by eighteenth-century rationalism (*architecture parlante*) and twentieth-century functionalism. No architectural form can be read unambiguously. And although it may admit certain indisputable interpretations, an expanded spectrum of messages is inherent to every form, and may acquire new meanings over the course of time, thereby assuming new functions. Moreover, even the simplest building represents a > situation of such complexity that although some traits may be legible, the situation is graspable only as an integrated experience. It is precisely this complexity of meaning, which need not necessarily be clearly deciphered, that is essential to architectural experience.

At the same time, the legibility of the distribution of functions and routes may render some forms of signage superfluous. This does not mean, however, that in place of written characters, the architecture itself becomes a set of signs whose code must be learned in order to render them legible; but instead that a building's form and configuration may render much of its content directly and vividly perceptible. We often say that the formation of a spatial > joint, for example, renders a directional change legible, or that the shaping of the embrasure indicates an > entrance. But mostly these forms lead us intuitively in a certain direction without the involvement of codified signs. Modes of expression such as > appeal, > invitation character, or > gesture display possible forms of behaviour, action and movement directly and intuitively accessible ways. While formalism and abstraction remove us from a self-evident intercourse with things, making the reading of sign-based information necessary by way of compensation, our direct intercourse with expressively designed architecture is clarified by shape in itself. At times, meanwhile, that which a building actually is – the way in which its architec-

ture acts directly upon us in order to elicit behaviour, to facilitate, hinder or compel specific activities – may be overlaid or disguised by the content of readings suggested by its form, by the meanings it disseminates or the stories it narrates.

Reciprocity	> context, intermediate space, inversion, space-body continuum
Reclining	> body (human), floor, form character, postures
Reference	> meaning, sign, symbol
Reflection	> darkness, colour, gaze, light, resonance space, surface, transparency, window
Remembrance	> memory, monument, place, time
Repose/Rest	> dwelling, form character, interior, movement, postures, ritual
Representation	> column, monument, ritual, symbol, sign
Repulsion	> body (architectural), circulation, concavity and convexity, field, form character, force field, space shadow

Residence

Reduced to a minimum, a dwelling is little more than a ‘place to lay one’s head’; in the broadest sense, it is ‘the way in which people are on the earth’ (Heidegger 1953/2008, 141). On the one hand, residence can be reduced to the physical existential minimum; on the other, it is a general and essential trait of our existence. Architecture does justice to this broad spectrum of meaning firstly by shaping a residence into a usable dwelling, and secondly by fulfilling the preconditions which allow residence to emerge as a universal basis for the lives of occupants. In both regards, residence must offer opportunities for retreat as well as for self-development. Their interplay shapes the various types of residence, so that a home’s architecture becomes a mirror of the lifestyles of occupants.

Particularly decisive for a residence is the relationship between individual and collective (1), the rapport between closure and opening towards the world (2), between stand-

ardization and leeway for appropriation (3), and the meaning of comfort and habit (4).

1. In its most economical form, a residence must offer a protected zone for secure sleep. In such instances, the bed or sleeping place can be conceived as the home's core element, as the most intimate private space, supplemented by its immediate surroundings (i.e. night table, bedside rug). As a sleeping alcove or canopy bed, it assumes the appearance of a small house. It forms the most confined spatial manifestation of the individual's > personal space; it is contained by the room and by the > dwelling beyond as though by a shell, and is supplemented by various functional spaces, and multiplied according to the number of occupants. In the context of collective living, the relationship between private sphere and common space is organized and articulated mainly by means of > accesses.

Adolf Loos propagated a division into public and private residential areas on disparate levels. 'The individual in a private home lives on two different storeys. He separates his life into two distinct parts. Into daytime and night-time life. Into living and sleeping.' (2002b) In fact, the separate grouping of rooms for individual use on the one hand and common rooms on the other on separate corridors or on different levels facilitates a disturbance-free utilization, while however reducing the likelihood of incidental encounters.

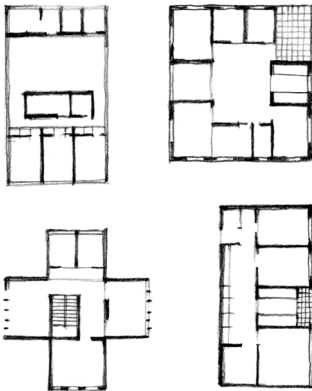

A clear contrast would be an arrangement that, for example, groups individual rooms around a common room that serves as the centre of the dwelling, and which may even open onto it. This configuration promotes a higher degree of communicative interaction between residents, at the same time conveying an image of the home as a totality; it does however, offer fewer possibilities for undisturbed retreat. Lying between these two extremes are various mixed forms that differentiate separation and > accessibility in a graduated way. Effects of separation can be minimized through the use of various levels that open onto a > gallery; in a flowing spa-

tial structure, conversely, graduated degrees of privacy can be distinguished through the grouping of functions.

Since the form of retreat into the private sphere that a single-family home makes possible is often regarded as the ideal, certain apartment types attempt to approach this form in the context of the multistorey building as well. The separate apartments that lie along a rue intérieure, as in Le Corbusier's Unité d'habitation, or along a street-style access balcony do not have to share landings with other units. Through its subdivision into levels, the maisonette apartment (French: maisonette, little house) suggests the multistorey structure of a genuine house. The private house may also take the form of the multistorey 'townhouse' within the denser development of the city centre.

2. Despite recent tendencies in our society to cocoon oneself in the home as an expression of a shrinking away from connections with the outside world, one that converts the home, according to Peter Sloterdijk into a 'system for blunting input from the outside', the home need not represent a total encapsulation of the private life, but can instead, in the words of Gert Selle, take the form of a 'closure in relation to the world, with the window opening towards the outside'. To be sure, the home is vulnerable; it requires an enclosure that offers protection and privacy. We can only receive guests because we are able to admit people selectively, and are confident in our ability to close off the home to intruders; opening and closing, then, are elementary and reciprocal acts of habitation. The possibility of retreat and defence, however, coexists with the necessity to freely regulate the relationship between public and private, seclusion and openness to the world.

Our relationship to the outer environment in the immediate vicinity is influenced by views from the residence and its surroundings. That which is visible from the window participates in shaping our personal sphere just as much as the four walls. Long-term residence at the same location, for example,

stabilizes a specific image of the surrounding town; this image is dominated by the views that open up from our home, so that a change of residence within the same town endows it with a different countenance.

3. While in modernity, it was the public sphere within which the individual develops, current trends towards the increasing valuation of privacy mean that we are only truly ourselves when we are at home. A residence, then, is not only a place of retreat, a protected space of relaxation vis-à-vis the impositions of social demands but also the realm of development of the personal sphere. Here too, architecture must create the necessary conditions. A residence, for example, must be more than a hiding place: it must provide freedom of movement. The plan in particular articulates both individual patterns of behaviour as well as social life. The standard spatial programme involving living room, bedroom, kitchen and bathroom has long since ceased to do justice to all of the relevant demands, and often proves excessively constricting. Heinrich Zille believed that one could slay an individual just as readily with an apartment as with an axe; undeniably, the architecture of the residence intervenes massively into our routine activities, facilitating, hindering or guiding the processes of daily life. Through his architecture, Le Corbusier, for example, not only propagated a new architecture, but also new forms of occupancy and new lifestyles. If a residence is to promote the development of an inhabitant's identity, the architecture must give him or her leeway for appropriation rather than restricting each room's function. The necessary architectural basis involves not simply more multipurpose rooms, but instead a characteristic spatial structure that offers the stage for intervention, for projections and traces of individual life. Incisively designed residential architecture that offers openness for individual appropriation as well provides the > capacity for personal ideas and forms of occupancy to accumulate and become invested with meaning. Greater latitude for forms of self-presentation is offered by the > furnish-

ings, which function as mirrors of individuality, as imprints of individual or collective use.

4. The question of whether one feels at home in a residence does not depend on either upon architectural expenditure or mere habitability. Goethe praises the proportions of the Villa Rotonda, but found the house, despite its 'luxuriousness', less than suitable for a noble family: 'Inside, it is liveable, but not homey'. (1786/1988, 55) Perceptions of hominess are strongly dependent upon the ideals of a particular epoch or social milieu. Today, our culture generally associates hominess with the > comfortableness of a warm, tranquil atmosphere. Judgements differ, however, about whether this quality should be achieved through opulent furnishings, or through the severe forms of a spare design. Walter Benjamin (1933/1999) went as far as to call for a glass and steel architecture in which it is 'difficult to leave behind traces'.

Although it is impossible to specify exactly which activities and individual functions belong to habitation, a certain repertoire of continually repeated activities is characteristic. Spatialization of these activities through the architecture and furnishings of a residence becomes a component of the > ritual of everyday life, and their familiar presence at customary locations leads to a sense of self-assurance. Residence, then, represents a use of architecture that tends more than others to be experienced only incidentally; inhabited architecture runs the risk of becoming invisible through sheer habituation. Nevertheless, architectural design can generate a scenic and atmospheric density that is perceived continuously on a subliminal or incidental level as a residence's character. It is not inconsistent with the familiar and frictionless flow of the daily residential activities when every now and then, and despite all routine, the architecture suddenly calls our attention to an unexpected perspective, spatial rhythm, or particular lighting that makes an everyday situation seem remarkable.

Literature: Bachelard 1964/1994; Bollnow 1963; Selle 1993

Resonance space

Going beyond the physical demands made on space, the sense of personal well-being requires a scope for spatial development that serves the vibrancy and echoes of movements and activities. A functional pragmatic measurement of space indicates the required space for various postures and activities, or as we read in Ernst Neufert's *Architect's Data*, 'the space between items of furniture required by the individual in order to undertake the necessary extensions of the hand and work comfortably, but without wasting space'. (2000) Effective as a space of resonance, on the other hand, is that spatial volume that is not required immediately for the bodily displacement of space or for real movement, nor for the performance of activities, but which instead extends the required space to include a spatial reserve. The term *resonance space* (Latin: *resonare*, to echo or resonate) should be understood as being analogous to the term resonating body, i.e. a space that amplifies sound by being brought to a state of resonance. Stimulated by a resonance space, then, is an expanded spatial volume that is required for the resonance and amplification of our feeling for space, which would otherwise be dampened and hindered in its impulsion towards expansion.

In some instances, one experiences a sense of spatial constriction when our presence and movement in a room is restricted to the practically necessary. A ceiling directly above one's head, for example, is experienced as oppressive, because it provides insufficient space for resonance. Even with activities that require minimal space, one must be able to take a few steps freely in each direction. In particular occasions for which the mind needs to roam free require a spatial volume for the greater > extension of our > personal space, one that offers reverberation, that allows us to expand without losing ourselves in boundlessness. Spaces of resonance, however, offer a passive echo only when they seem homogeneous and tranquil, and do not offer stimulus. When they for this reason remain in darkness, small openings that admit light into the depths of the volume or weak reflections avoid

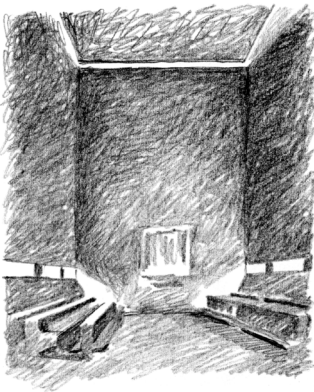

allowing them to seem wholly dead. The acoustic capacity of materials to resonate also supports effects of spatial reverberation.

Retreat

> accessibility and exclusivity, ascent, cell, gallery, interior, residence, space-containing wall, territory

Rhythm, spatial

Musicality is in evidence in architecture less in an ‘ossified’ or ‘frozen’ state (Friedrich Wilhelm Schelling, Arthur Schopenhauer), and more in the rhythms through which we traverse space. In a building, every serial arrangement, from rows of supports to rows of houses, can be grasped as a purely mechanical and uniform repetition, as beat or pulse (> row). In contrast, rhythm emerges when a lively succession is derived through the variation of a monotonous and strict schema of repetition. Rhythm appears as a recurring accentuation; Ludwig Klages (1944) speaks of a polarization of a periodic, structured correlation. While *beat* or *pulse* means a repetition of the identical, it is the similar that recurs in rhythm. It therefore allows changes that do not call into question the continuing coherency of the sequence. The term rhythm is derived from $\rho\acute{\epsilon}\omega$ (*rheo*), the Greek word for *flow*, so that with reference to its origins, it can be translated as ‘articulated continuity’, i.e. that of waves in water. Rhythm as a polarized continuity is found in the ceaseless alternation between day and night, ebb and flow, and the serial repetition of an irregular sequence, on the other hand, in periodic life phenomena such as walking, breathing, or the beating of a heart.

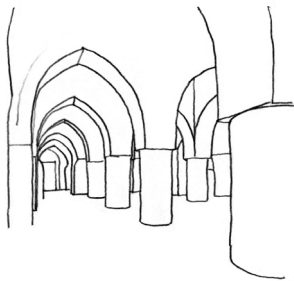

In architecture, a beat or pulse appears as an element that is repeated strictly at identical intervals, for example a row of supports or window openings. Rhythm modulates this strict sequence by grouping it, generating disequilibrium. At times, the beat must be added to the continuity of movement, so that rhythm is experienced in direct contrast to it.

Occurring in architecture primarily are two types of rhythm, which at times coincide. First, rhythm serves as a means of visual design that subdivides, enlivens and integrates structural forms. Second, rhythm serves as the basis for real movement, that is to say: a rhythm that is articulated in spatial forms, and which has an impact on our movements or immediate bodily sensations.

In the first instance, rhythm in architecture is actually perceived in a frozen state, that is to say, as rhythmical suggestion. With reference to the Greek temple, Heinrich Wölfflin, for example, distinguishes between strictly bounded and light, floating rhythms, the difference between them being dependent upon the distribution of triglyphs in relation to the row of columns (1886/1999, 32). The visual appearance of rhythmic subdivisions is read this way, from individual ornaments to the animated contour of a roof, or even the silhouette of an entire cityscape. In such static images, of course, the rhythm comes alive mainly through the scanning activity of the eye.

But rhythm in architecture is experienced adequately only actively, through one's own (at least imagined) movement. In walking itself, movement is composed of multiple rhythmical-polar elements, whether forward, backward or sideways, of rising and falling motions, alternations between right and left, all of them characterized by variations of duration and emphasis. In concrete instances, the length, rhythm and velocity of our steps overlap with the rhythmic traits of architecturally interrelated spaces. Through the specific sequence of room forms and sizes, with its alternation between narrowness and expansion, ascent and descent, brightness and darkness, our movements are influenced in such a way that we adjust ourselves in relation to this spatial rhythm, following it, sensing the way it pervades our movements.

In a rhythmic sequence, variously interconnected spaces influence one another reciprocally allowing an adequate overall image only when they are traversed successively, whether this involves the linking together of interiors, or a coherent

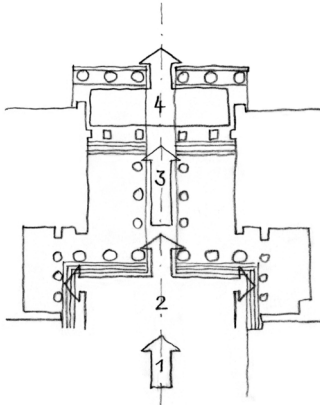

sequence of > squares and streets. As an example, Jürgen Joedicke describes the figure of movement when performed in traversing the Propylaea on the Acropolis as the rhythmic alternation between restraint and impulsion effected by the transverse and longitudinal arrangement of the various positions of the columns in the successive segments of the building.

Plans and sections as ‘choreographic scores’, but also contrasts between light and shadowed zones, between segments of space having diverse acoustics or contrasting atmospheres, are factors of architectural rhythm. The affinity of architectural rhythm for dance and music becomes explicit on certain occasions, for example via almost dance-like > figures of movement that, when executed on staircases, foster an alternation between linear movement, rotation and turning that is further accented by the landing as a place of rest. But rhythm only affects someone who is receptive to it, who is ‘captured’ by it and allows himself to be carried along.

Literature: Brinckmann 1956; Schmarsow 1915; Zucker 1924

Ritual

Ritualized actions require corresponding spaces. Such spaces are not only components of ceremonies in representative or social contexts or liturgical practices in sacred cults; in everyday situations as well, rituals are articulated spatially. Here, architecture is simultaneously the setting for and an element of interaction in a scenario of action that proceed according to certain rules. Rites of passage and of transition in the general sense are designed to render complex, critical, or fundamentally new life situations comprehensible through formalized action. They receive spatial expression for example in processes of the ritual transgression of boundaries, i.e. during weddings, the ceremonial opening of closed doors during dedications, at Christmastime, or during burial ceremonies.

Even during the crossing of a threshold in everyday life, the insecurities caused by passage into unknown spaces or

the entrance of unknown individuals are negotiated by rituals that involve the control of admission, greeting, or reception, or endow an entrance with special dignity. For this purpose, the threshold area is expanded into an > intermediate space. It may be a security buffer within which border officials, gatekeepers or doormen either allow or refuse admission according to certain rules. During detainment in anterooms during control procedures and waiting periods, the applicant for admission submits to rituals that express his or her dependent status. In other instances, guests are welcomed, are admitted into reception areas with representative functions for the purpose of greeting rituals, which in the simplest form consist of a corridor or entrance hall. Among customs associated in many cases with > ingress and exit are the removal of shoes or articles of clothing, or rituals of hygiene, with the corresponding requirements for spatial infrastructure. Ceremonially heightened forms of reception are made possible by vestibules, foyers or reception halls, where a red carpet is rolled out in welcome, and where guests are met prior to entering beneath a projecting roof and led into the building. As settings for acts of greeting and ceremonies involving reception and escorting, prestigious staircases often assume substantial dimensions.

In many instances, threshold rituals proceed as processional forms involving entering, exiting or circumambulating a building. In the type of the antique *peripteros* or the basilica, for example, such forms of movement are accompanied on one or both sides by rows of columns, which rhythmicize (> rhythm) the forward motion of the procession. In such cases, the architecture suggests a striding motion rather than a simple walking. With movement on staircases or ramps in particular, the pacing and speed of the step is influenced by the respective mode of ascent. The Temple of Hatshepsut in Deir el-Bahari or the Roman temple complex at Praeneste embody grandiose scenarios of ascending processional movements on ramp complexes.

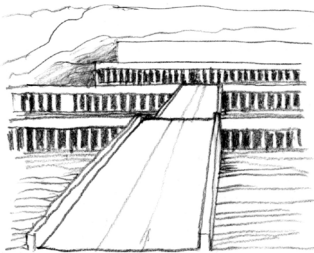

Through ceremonial or ritual actions, social relationships are endowed with expression. The barriers of a courtroom, for example, display the battle lines of > confrontation, the seating arrangement in a parliament building mirrors the distribution of power, while a 'round table', in contrast, reflects attempts to reach agreement. Options for making entrances or for self-presentation are formed through raised stages, altars or staircases. Such arrangements imply hierarchy, with the most important actors or objects – i.e. cult image or action, or ruler – being presented above, while the process of approach is enacted via > ascent, together with the deliberate-ness and effort associated with it. Through the sequence of rooms, the enfilade of a princely residence indicates the degree of > accessibility for individuals of various ranking during receptions.

To begin with, religious worship calls for an architecture that evokes the kind of sacred atmosphere and numinous mood that are suggestive of reverential or respectful forms of movement and speech. Against this background, the other ceremonial components, including > sound (music), > odour (incense) and ritual movement appear to be integrated into a specifically sacral spectacle. The spatial structure of church architecture sketches out liturgical movement sequences, solemn entry through the main portal during special occasions and via the central axis of the middle nave towards the choir, as well as via the steps leading to the altar. This movement is often contained by > centring or by a concave spatial terminus; the celebrant circles the altar and turns towards the congregation, which stands across from or has gathered around him or her.

Nearly every activity can be celebrated when time is devoted to it and it is endowed with a certain form, to which the spatial furnishings also contribute, whether it is a question of the *lever du roi* as enacted around the royal bed of state with grand displays of splendour, or the individual process of bathing in the more recent reductive aesthetic of the ritual

bath as a place to luxuriate in ‘peace and retreat’. The rituals of purification taking place in Roman or Turkish baths envision differentiated special sequences, while the ritualization of dining in the framework of a celebratory banquet prescribes a specific seating and table arrangement. Even in the traditional home, the living room as a symbolic space was for a long time taboo in relation to everyday activities, its ‘cold splendour’ reserved for special holidays.

On the scale of the city, customary rituals are enacted by preference on those public plazas which architecture has imbued atmospherically with a sense of history. Other rites are performed on special celebratory squares, and incorporate the entire town during pageants. During special religious ceremonies as well, the performance of liturgical rites exits the sacred context to enter the public urban space. During processions whose points of departure and arrival are cult sites, an example being the Spanish *semana santa*, religious ritual lays claim to the urban realm as an expanded sacral sphere. Only the monumental > scale, in particular when it transmits a feeling of great > size, forms spaces that span distances while providing a sense of distinction and exclusivity. Axial layouts give movement a directional orientation, and a frame suitable for parades and military deployments or marches (> axis). A ritual strolling devoted to seeing and being seen, on the other hand, takes place daily on the boulevards, promenades and esplanades, primarily in southern countries, for example in the form of the *passeggiata* that is enacted every evening in Italian towns. At spas, promenades are often contained architecturally by sweeping colonnades.

In ritual situations, all of the participants feel themselves called upon to adopt a specific attitude. If, however, one resists the demand – expressed by the totality formed by architecture, ritual action, and the requirements of ceremony – to adopt an appropriate mind-set, then the entire situation may be perceived as an imposition.

Roaming

To roam spontaneously and aimlessly is one of the pleasures offered by architecture and by the city; and moreover in two senses. In one instance, it is a question of straying through a tangle of spaces and routes, of meandering and even of losing one's way; in the other, the situation allows us to saunter freely and unhindered across an open plaza, or to move across the floor of an expansive hall. Common to both is a type of movement the directionality of which is not prescribed by the architecture, but follows arbitrary impulse, to some extent without definite intention, according to individual whim. The way forward is decided spontaneously from moment to moment. Without travelling towards any goal or destination, and with changes of direction following one's pleasure, one is carried along, absorbed entirely in the present moment and the architectural experience it offers.

In the first instance, the individual delights in the rapid and unanticipated reversals of direction that are triggered by continual changes of situation. In the unpredictable situations that are encountered within the city or spatial structure having high > density and without recognizable directional cues, boundaries or centre, one yields to surprise, satisfying one's curiosity about unexpected discoveries, yearning to see what lies around the next corner, what is likely to emerge from behind a wall or pillar. More than others, this mode of movement is an intensive form of experience, the appropriation of architectural space and of the city. There is an affinity with the so-called *dérive* (French: to drift, to be carried along) of the Situationists, which seeks out a self-determined, free interpretation of urban structures, in which context roaming is held to contribute a subjective image of the city. In roaming, one conquers an unknown space and penetrates into diffuse spatial > depths. If the surroundings become too unpredictable, this mode of movement shifts towards that of wandering around in a labyrinth, within which one enjoys going astray, but at the same time fears becoming lost. While we associate such wandering with > movement on a plane, such

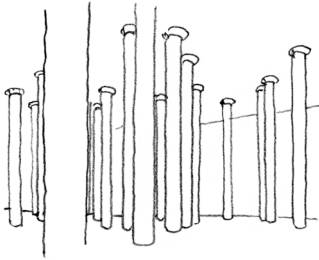

roving and straying can also extend in elevation heights as well.

In the second instance, roaming is a kind of pleasurable strolling. On an undivided and unmarked surface, movement is neither guided along tracks nor blocked by obstacles. Without goal or prescribed direction, one follows only one's own impulses. The structural preconditions for this mode of movement are provided by empty open spaces and unobstructed planes, the expansiveness of large plazas or landscapes, large > halls or rooms, or > flowing spaces without obstructions and with readily changing foci. Spaces for roaming as > fields of indeterminate possibilities include hypostyle halls with loosely distributed columns whose non-hierarchical homogeneity avoid indicating any particular direction for movement. Roaming movement follows the roaming gaze; horizontality is dominant in such situations, stimulating us to range widely throughout the space. A special role is played by the > floor, upon which our steps follow only the lines of an individual choreography, as on a playing field or dance hall, where one's own movements are enacted in an unconstrained state of mental animation. Erwin Straus (1960) has referred to the type of space for which the aimless movement of the dance is characteristic as 'presentist', meaning that it is wholly detached from the framework of historic action and from time, is devoted entirely to the moment. It is not movement through space, but instead within space, and encompasses rotation and backward movements that would normally seem absurd. As the 'lived expression of the movement of life' (Hasse 2005), it is self-sufficient.

Literature: Debord 1958; Straus 1960

Roof

Pars pro toto, the roof stands for the > dwelling. To have 'a roof over one's head' is the minimum condition for establishing an abode. The character of this particular form achieves its purest expression in the separate roof, which takes the form

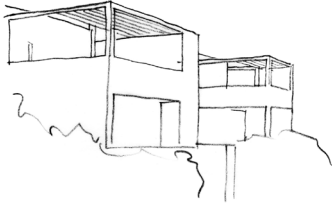

of a simple shelter or rain covering. In contrast, the flat roof, an inconspicuous horizontal panel that is simultaneously visible within as a ceiling, displays its protective function with a more muted expressive force. At the same time, this form assigns the roof with an additional function, that of a leisure or lounge area. Beginning with Modernism, roofs – now fitted out with terraces and gardens – became components of outdoor living, and at the same time came to represent an additional facade. By means of the roof terrace, Le Corbusier strove to compensate for the land that was used up by the house, creating highly prized outdoor leisure spaces on his flat roofs, not only using the roof surface as a floor area, but also marking out its boundaries by means of individual walls and framing constructions. The experiential intensity that is characteristic of the roof, however, is offered in particular through its traditional form, with a clear distinction between external and internal. To the inside, it gives the ceiling its form, while towards the outside, it is visible in the characteristic forms of slanted surfaces, folds, vaulting and overhangs. In this way, it also transports meanings. Even after the introduction of the flat roof, the saddle roof continued to embody a familiar image of the house, as seen in typical children's drawings, and remains for most people a symbol of home and dwelling.

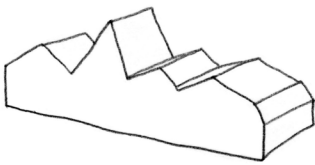

Through its form, the roof is also capable of establishing connections to neighbouring houses or buildings, of linking up with them through the continuity of the roof line, fusing their respective volumes together, or generating a common rhythm through repetition of form. Through the forms of the roofs of buildings, the topography of a landscape may be distinguished as a 'roofscape'. In many instances, it is the form, position and arrangement of roofs that endow a town or region with its unmistakable character. Through the idiosyncratic design of special forms, however, a building may detach itself from the local context. In general, roofs make important contributions in shaping urban spaces. The forms and positions of roofs play an important role in shaping the

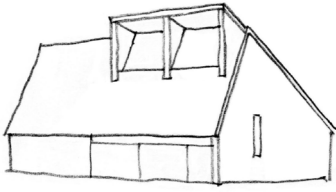

homogeneity and coherence of squares and streets, for example when the fronts of houses display either eaves only, or gables only. Through contrasting roof forms, however, houses confront one another with individualized > gestures, turning towards one another, for example, with pent roofs or large roof openings, reaching out into space with large projections, or centring other buildings around themselves by means of a cupola. The form of the roof is not only recognizable from a distance, but also displays itself through gables, eaves or roof projections. With cornices and overhangs, the edge of the roof indicates a virtual upper terminus of the public space, and forms the boundary of an imaginary roof that spans a plaza in virtual terms.

The roof edge also forms the upper terminus that is required by the external form of the building itself; even the flat roof building displays a terminus in the attic. An elementary characteristic of > tectonics is the distinction between below and above, one that comes to expression in the contrast between the pedestal, which rests firmly on the building ground, and the superimposed crown or added covering of the roof. While the flat roof – at least from the conventional viewing position – adds little to the plasticity of a building, the inclined roof can be interpreted as a continuation of the outer wall that completes or rounds off the (convex) gestalt of the building at its apex. The closed character of the flat roof reinforces the building's visual corporeality and solidity, enhancing its sculptural affect. The specific treatment of the roof covering, meanwhile, an imbricated covering of roof tiles or shingles, the application of a thin metal layer or fur/hide structure in the form of straw or reeds, is perceived as an independent epidermis-like layer.

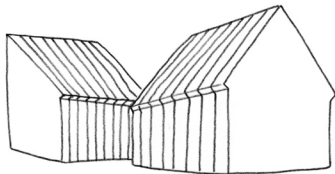

With its differentiated articulation, the roof offers the possibility of rendering the building's ground plan or its assembly from various components legible from the outside. The forms of the interior are mirrored in the composition of various roof elements. On the other hand, a unified roof is



also capable of pulling together a multilimbed building as a totality. As a rule, the peculiar gesture of the building culminates in the roof form; at times, a roof may even evoke physiognomic associations with specific life-forms, with faces or whimsical coiffures. In its peculiar design, it is reflected in the building's interior as well, i.e. when the roof's form influences internal spaces.

As a rule, when viewing a building from the outside, and with the exception of the canopy shelter, open hall, or pavilion, we do not see what is going on beneath the roof. It merely suggests the protected space within, evoking expectations and inviting us to enter. A large roof projection or exceptionally low eaves already intimates the introversion of the interior. It constitutes a preliminary stage in the sense that we have already reached an 'interior', or at least an > intermediate space, when we step past the outer edge to stand beneath the protecting roof. Once inside, however, we normally see nothing more of the roof. To be sure, we carry its design inside with us in the form of an expectation, but in most cases, it is represented within only by the ceiling of the ground floor. Only in special instances, such as vaulted spaces or those topped by cupolas, holes or barns, does the experience of the interior coincide with the impression of the roof form we have received outside. Then, the space is oriented, centred or subdivided by the gesture of the roof form, expanding upwards or being compressed, thereby suggesting specific figures of movement.

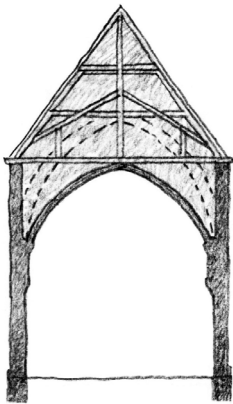

The difference between roof and ceiling, on the other hand, reflects their divergent tasks as external building form and inner spatial container. While outwardly, the roof suggests mass, the ceiling represents the sky. In the interspace between them, in the > *poché* of the cross-section, we find ourselves 'inside' the roof, not the roofed interior of the building, but instead a secluded, barely illuminated zone that offers minimal visual accessibility. Recognizable within the open truss or roof structure is the rationality of a building's construction; in the twilight, at the same time, the dusty crisscrossing of the

beams struts offers itself as a clandestine retreat. We ascend into these upper reaches – loft, storage area or attic room – in order to hide objects or to conceal ourselves.

Literature: Burren et al. 2008

Room

> ceiling, cell, interior, residence, space

Route

Routes are formed by the acts of walking. In the undisturbed landscape, pathways form from the traces of frequently travel, which gradually become routes, which are finally widened into spaces having their own gestalts. We gain access to space by walking, and various forms of walking represent the formalized expressions of our mental states. In a fundamental way, our gait is oriented forward by our bodily disposition, with its front/back depth axis. A line runs from a person towards a goal. The same travel route is not identical coming and going, because the return has an altered goal and a reversed perspective.

Michel de Certeau (2011) has characterized ‘walking in the city’ as a form of expression that is analogous to speaking a language. Through the routes that we choose, we enact space, actualizing one among the many possibilities for using urban space, excluding others, and adding new ones through our activity. Walking is a form of appropriation, the ‘spatial realization of a place’. But in addition, chosen routes are lines that are read for their meanings, where we moreover leave traces that remain in > memory, and which can be reread and at the same time store memories. Trade and pilgrimage routes manifest this on the scale of the landscape. In a home, routes belong to the > figures of movement through which traces of action and patterns of activity assume form, and which are in turn objectified through furnishings and fittings.

According to the psychologist Kurt Lewin, a conception of space that is based on opening up through routes, ac-

cesses, and connections is referred to as a *hodological space*, as a 'route space' (Greek: ὁδός, *odós*, path, way). In such a space, directions appear in place of indications of form, orientation and distance; it is permeated by routes and streets. In hodological space, routes do not link points together, but places that have personal significance; their course is oriented towards personal preferences and dislikes, and serves a generalized > orientation within the living environment. Decisive here is not the geometric order of the plan, but the accessibility of individual areas which results in a specific perception of distances, proximities, and a total image of the > spatial structure of a city or of a building. The path from one side of the wall of an apartment to its reverse side (in the neighbouring apartment), for example, is disproportionately large in relation to the wall's actual thickness – and there being may be no path that leads there at all.

In general, we distinguish a route space that is dominated by its traversal, as displayed in its design, from a position space, whose architecture is tailored to stationary use. But the space occupied by the route itself too can be referred to as a route space. Routes are subordinate to the places that they connect, but are at the same time themselves > places, and offer their own modes of experience. Route intersections, in turn, form special places. Routes have their own gestalts, and constitute their own spaces. The streets between house fronts, for example, can be grasped as concave interior spaces. On an avenue, tree trunks form the walls, and foliage the roof. The stability of the design of a route offers security; we know that the street continues further, without seeing where it leads. The identity of its gestalt renders a stepwise, searching orientation superfluous. Relieved of the need for decision-making, our attention is free for other concerns; a stroll along a promenade is an opportunity for conversation; > circulation through an ambulatory promotes an attitude of contemplation.

The architecture guides a route through the rhythmicization of the space, past visual targets, past the attractive power



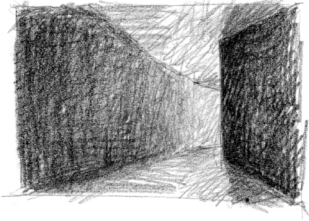

of the > lights, through directive elements such as guide walls and paths/lanes, supported by materials particularly of the paving, and endowing walking or driving with various qualities. At the same time, perception is dependent upon the various velocities of walking or driving, and perhaps also on the type of vehicle. Details, for example, are perceived only when walking; at higher speeds, the route seems telescoped. When travelling with a baby carriage or in a wheelchair, the path betrays obstacles concerning which others remain unaware; the skater experiences paths selectively relating to areas that are navigable. In a system of routes, places, which take the form of spaces, squares or centres, constitute points of reversal between travel and arrival, between departure and disappearance. The architecture articulates such reversals through the formation of > joints and > intermediate spaces. Routes, spaces, and places, however, are actualized through concrete > movement. In the words of Michel de Certeau: 'The play of steps is the shaping of spaces. It weaves together the basic structure of places.'

Row

When progressing uniformly, the row strides towards an often unrecognizable destination. As the articulation of a whole, in contrast, it represents a rigid order. Arranged along a continuous line, whether straight, curved or circular, it is a repetition of the same individual element or a subdivision of the whole into equal parts. It can be grasped as the juxtaposition of elements in a static order, or successively in motion, as monotonous uniformity or dynamic progress.

The alternating sequence of steps between right and left we experience when walking appears abstracted in the simple series. In architecture, this corresponds for example to the sequence of steps of a staircase. Rows of supports or > columns, > arcades, > galleries, or the trees lining an avenue accompany the action of walking with a uniform beat or pulse. But it is only > rhythm that transforms it into animated movement.

The uniform beat of a simple row or series, on the other hand, is the simplest visual or kinaesthetic articulation of a temporal progression, as shown by the ticking of a clock. In the grid, the serial principal can be regarded as an expansion of the row onto a plane surface, and the space lattice its expansion into three dimensions. As a neutral form of subdivision of a field, the grid – like the series – generates an initially empty basis for an ordering overview and for various positioning. It offers the freedom to ‘fill in’ the field in highly individual ways, and is hence capable of accommodating highly diverse forms of overall experience.

In contrast to the hierarchical order of the series, which proceeds towards a terminus, or culminates in a centre, the pure series follows an open, egalitarian order. In both cases, the strict rule yields a certain degree of heterogeneity to individual elements, for instance the changing wall colours in an > enfilade, or the individual decor of a series of row houses, albeit without calling the serial principle into question. Only against the background of the role of the series does the variety among individual elements become conspicuous.

The result in one instance of the mechanical repetition of a purely technical procedure, the series can be grasped in others as a deliberately repeated arrangement through which each individual position is strengthened and continuously heightened in relation to its significance. On the one hand, a uniform series risks monotony, and can even result in fatigue; on the other, it is precisely the endless continuation of the identical that contains an element of irritation or magic, and has the suggestive impact of a litany or a persistent ostinato. The optical superimposition of series of posts staggered behind one another in high density generates interference effects and an impression of vibration. While Giorgio de Chirico elicited expressions of melancholy from arrays of arcades in his paintings, Étienne-Louis Boullée placed special emphasis on the effects of > sublimity and > grandeur that could be evoked by endless rows of columns. Because their open-ended termini

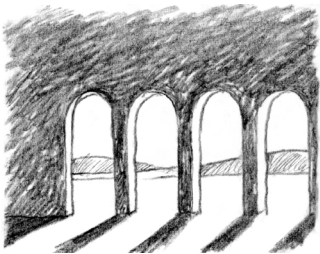

can be extended indefinitely, an apparently endless series can evoke a sense of yearning towards infinite distances.

Literature: Berndt et al. 1977

Sacral

> atmosphere, darkness, light, monument, ritual, sound

Scale

Through choice of scale, a spatial > concept is set into relationship with concrete reality. According to Philippe Boudon (1991), it is scalar relationships that distinguish architecture from geometry. The scale not only indicates the relationship between a model or drawing and its realization, but also supplies the fundamental law for translating the mental space of the architectural design into the real space of built architecture, where it is now subject to concrete experience. In contrast to > proportion, which orders the ratios between various parts of an object, scale refers to the relative size in relationship to other objects, to a customary reference magnitude, an external reference area, or reference system. The human scale of architecture is related, for example, to the dimensions of the human body. In this context, we may speak of a 'leap in scale', of an object being 'true to scale', or of confusion caused by a 'scale error'.

The various reference areas are also formed by the perceptual spaces that result from various distances. The task of architecture is to coordinate these various scales with one another within an architectural complex. The detail scale, for example, corresponds to perceptions in the close range, where profiles, joints, ornamentation and masonry bonds determine magnitudes (> detail). In an expanded perceptual space, the entire building is perceived at a distance as the assembly of the whole from larger parts and in its spatial context. One and the same form, for example a pedestal articulation, can be read on various scales according to the reference system and perceptual distance, and it thereby has contrasting ef-

fects. The sense of scale also changes when we approach a building, and depends upon proximity and upon the change from a flat distant image to a three-dimensional architectural body. Finally, the visual is converted into the haptic.

Architecture also makes perceptual offerings on large and small scales. While excessively large planar formations lack internal structures that would supply sufficient information when perceived from minimal distances, an articulation by means of projecting and receding elements, which have a receptive function or act as visual targets, break up larger structures into smaller units and make large-scale objects seem more accessible by allowing visitors to locate themselves in terms of scale. When, on the other hand, homogeneous buildings and surfaces display small-scale structures or patterns without overarching articulations of the total gestalt, they generate the non-scalar image of a seemingly artificially, self-sufficient architectural body.

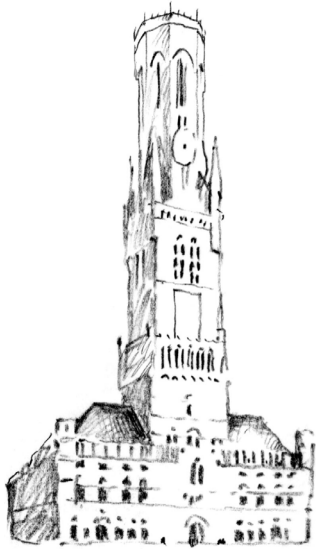

Depending upon > context, the reaction to proximate and distant objects in different directions may call for attention to various scales. The urbanistic or landscape scale that is valid for a specific instance depends on whether we perceive a public square or street zone, or an entire town or landscape from a distant view. In a city, for example, > the relationship between the locations of towers that appear as individual bodies from close by may form an independent scalar system that allows them to function as points of orientation when viewed from greater distances.

One speaks of 'human scale' in particular when the > dimensions of the human body furnish reference values. As a system of measurement that works with the multiplication and subdivision of human dimensions, these reference values are not easily perceptible – leaving aside issues of general design consistency. Such reference values are graspable in concrete terms in particular as the relationship between bodily masses at the spatial range or reach involved using doors, seats, tables, staircases or compartments, and are effective

mainly at close range. Measured by this standard, buildings and structures cannot be arbitrarily enlarged or reduced in scale in all of their parts, since a resident cannot be scaled down accordingly; the widths of shoulders, the height of heads and eyes, the length of the stride form reference values. When the dimensions of a building far exceed those of the human being, when rooms or doors, for example, are far higher than a human head, the results are often associated hastily and in a clichéd manner with overwhelming or humiliating effects. The question of who confronts such scales, and under which conditions, should however be considered. Depending upon the situation, elements of excessive scale may also cause the effects of generosity or uplift. The yardstick for a kennel is the dog's body, but a human being expands into space beyond bodily dimensions to fill it by his or her > personal space (> body, human), and a larger scale may give rise to feelings of largeness and freedom. In Verona, Goethe remarked that only the presence of the public gives the arena its scale, which it still lacks in an empty state. Since the measure of each individual head serves to make the whole sensible to each, 'such an amphitheatre is constructed in order to allow the people to impress themselves' (1786/1988, 40).

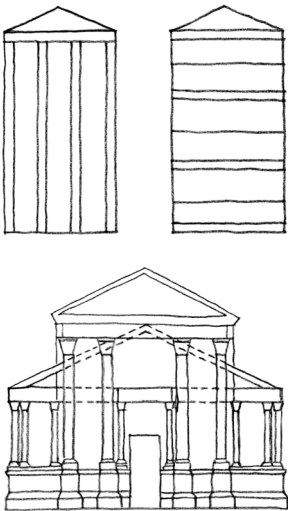

The apparent (as opposed to the real) > size of a building is often dependent upon its relationship to reference elements whose normal sizes seem readily recognizable, for example the customary heights of storeys, the sizes of doors and windows, whose measures render distances and sizes intelligible. Where such elements depart from customary dimensions, they alter the scale of the building. While the scale and size of unarticulated built forms is difficult to evaluate, their assembly from parts renders them intelligible; articulations without connection to the interior spatial structure, however, seem arbitrarily imposed. Various proportions and articulations of a building through orders of columns, mouldings, and facade articulations allow a building to seem stocky, compressed or elongated, and hence to appear in various scales. 'On the

other hand, it is possible for a building that looks large to fail to convey a feeling of size', says Geoffrey Scott (1914). This author considers 'scale' in relationship to ornamentation or details that are subordinate in relation to larger elements: because we instinctively take the detailing of the building as our standard of comparison, the largeness and simplicity of unbroken architectural masses make an even stronger impression on us in relation to them.

In instances of scalar enlargement, not all of the parts of the building can grow proportionately. When the span of girders is increased, for example, the height of the girders must be increased disproportionately. Spatial perception too is altered through increases of scale, as Rudolf Arnheim (1977/2009) demonstrated. Because a volume grows more quickly than the surface of its envelope, the spatial envelopes of larger buildings seem weaker and offer less stability – even where wall thicknesses grows proportionately as well. For the same reason, the walls of a large room press into the interior more strongly than in smaller ones, despite the fact that freedom of movement is enhanced with the increase of space. 'Form does not follow increase in size so simply,' Paul Valéry has Eupalinos say, 'neither the solidity of the materials, nor the directing organs, could endure it. If one quality of the thing increases according to arithmetical ratio, the others crease otherwise.' (1923/1956, 139)

Literature: Boudon 1991

Scene

Scenographic architecture is always the stage upon which we present something – including ourselves – for the purpose of watching it, or of being watched. This type of architecture has a wide-ranging set of instruments for illusionistic display, for example, the resources of perspectival legerdemain or atmospheric defamiliarization. It provides a platform and stage setting for the grand ceremony or the minor > entrance, for theatrical performances, for staging liturgical ritual, as well as

for featuring everyday events in which actors and spectators are involved.

With architecture, however, in contradistinction to the theatre and to scenography, it is not generally a question of a performance before an audience; instead, we experience architecture scenically primarily as actors, and as the spectators of our own actions. This becomes possible because we are capable of regarding ourselves and our position in the world with some measure of distance. 'He not only lives and experiences; he also experiences his own experience'(1928, 292). With these words, Helmut Plessner characterizes this particular form of human experience of the world, at the same time coining for it the term *excentricity*. 'If the life of an animal is centric, then the life of the human being is – and without breaking out of this centring – at the same time emerging from it, excentric.' (ibid.) Since our bodies always assume positions in space, having their own extension and boundaries, and since our relationship to the world is always shaped spatially, this particularity of our excentric self-understanding is also experienced in specifically spatial terms. To become self-aware, to watch oneself, then, means to be aware of oneself in space, to regard oneself with and in a spatial > situation. In a fundamental sense, then, human > experience is always scenic experience. Based on our excentric self-perception, we can consider any place where we abide, as the stage where we enter, first and foremost for ourselves, sometimes but not necessarily for others as well.

For the human individual, space – and in particular designed space – plays an elementary role as the setting for such scenic experience. The excentric disposition of human experience already contains an aesthetic moment: the aesthetic attitude too is based on a sense of distance in relation to specific situations; it detaches the situation like a scenic > image from purely functional reality. Architecture favours this aesthetic perspective through the scenic framing of everyday situations. But it is neither a question of theatre architecture nor of the-

atrical architecture, nor of settings that are prepared scenographically. Instead, every designed space can potentially convey to us the impression that it was made for us as a scenic frame that converts our actions into the object of our own attention. In fact, all life processes can be thematized by architecture, to the extent that they can be articulated spatially. In contradistinction to artificial themed environments, which transport visitors into a fantasy world and which, as alternative worlds, allow day-to-day normality to be forgotten, architecture has its point of departure in the fundamentals of perception and movement, and in the elementary processes of our daily interactions with space.



The act of climbing a > staircase, for example, can be transformed by a constructive arrangement according to dramaturgical considerations into a scenic experience, so that we follow our own movements through space like a performance. In a way that is analogous to the actions of an actor on a stage, which generate a second reality through the production of a play, the reality of the purely functional act of ‘ascending stairs’, which can also be performed indifferently and non-thematically, becomes thematized through a self-reflexive experience that stimulates an attentive performance. Unlike the theatre, the act of climbing the stairs need not narrate a ‘story’; instead, the architect already discovers the decisive incident and action in the constructive task itself. In architectural design, pure functionality is transformed into an experiential reality, one that thematizes the function itself. The function of level changes can be staged by an expressive > gesture; a purely functional movement can be invested with a certain rhythm; the effort of ascending (> ascent) can be transformed into a dramatic sequence; perception and orientation are enriched by a characteristic > atmosphere. Between the dark grotto below and the floating platform above in Balthasar Neumann’s Bruchsal Staircase, I see myself climb directly from the extremes of the gloomy depths below into the bright expanse above. The mythological ‘narrative’ of heaven and

hell is added only at the symbolic level. In a way analogous to the scenic processing of the active climbing of a staircase, spatial relations of all kinds can be scenically shaped by architecture by taking a specific form of movement or type of action, that is to say the respective > use for which the space is intended as a point of departure and treating it scenically.

To be sure, we do not wish to constantly experience our own activities and movements scenically, but generally prefer to perform and perceive them incidentally. Yet the scenic potential of an architecturally shaped situation offers an opportunity to heighten the intensity of spatial experience as desired through special attentiveness, and to take advantage of the opportunities for making entrances that are offered by architecture in the framework of everyday life as well. But *en passant* as well, the scenic power of an atmospherically dense architectural design is subtly noticeable in ways that allows us to become suddenly aware of the special features of a situation. *Literature: Frey 1925/1946; Janson/Jäkel 2007; Plessner 1923, 1928*

Screening

The interplay of separation of and connection between spaces is constitutive for architecture, and becomes concrete in screening. It encompasses two complementary partial processes, that of entering and exiting. This presupposes a demarcation between various rooms, and at the same time the possibility of overcoming it. The opposition between division and connection that is kept by screening effects in particular the relationship between > inside and outside, and can be traced back to a primordial architectural act, the delimitation of a space of human experience by means of a shell, and its exclusion from the continuum of natural space. In general, phenomena of screening are also evident in the relationship between all types of spaces or spatial divisions that are closed off or opened up to one another by degrees.

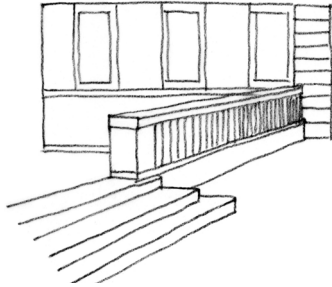

It is not just the spatial envelope that is effective as a screen, but also enclosures of various kinds, along with > thresholds, steps or boundary lines, that can be transgressed. The screening of a > territory may be soft and flowing, manifested for example solely through a gradual difference of levels, or through a subtle zoning effected through light and shadow or change of material, and in extreme cases even simply as a sonic or climatic island.

The principle architectural resource for screening, however, is the > wall with > openings. As closed, vertical planes, walls are, first, obstacles to movement and perception; they divide the space within which we find ourselves from an external one, the space we occupy from an initially inaccessible one. Normally, that which we identify as a wall has a rear side, and is thereby also related to a different space; by means of this two-sidedness, it connects the two. In particular, through an interplay with openings such as > doors and gates or > windows, the wall expresses an ambivalence between division and connection. Depending upon construction and materials, various degrees of permeability to views, light, sound or movement in various combinations modify its function as communicative > filters.

On a scale of hermetic > closure to extensive openness, the requirements of separation – the need for shelter, for example from inclement weather, light or noise, and the securing of privacy or defence – are balanced against those for connection – i.e. the desire for views to the outside, contact, and opportunities for self-display. The double function of division and connection served by screening, finally, makes possible a scenic or voyeuristic interplay between concealment and self-presentation, of withdrawal and self-display (> scene). In many cases, objects or individuals that remain only partially visible or only vaguely suggested behind a screening wall are imbued with the appeal of the hidden. Their emergence into visibility through the permeability or opening in the wall becomes an active unveiling or an > entrance that is supported

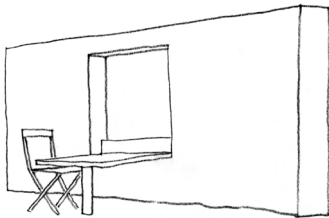

by the emblematic impact of the field of the wall that frames the opening.

Literature: Baecker 1990; Feldtkeller 1989

Sculpture	> body (architectural), image, sensory perception, surface
Seating	> body (human), furnishing, interior, movement, postures
Security	> dwelling, orientation, ritual, route
Self-referentiality	> architecture, experience, scene

Sensory perception

Unlike the priority of vision for pictures or hearing for music, no one of the five senses can be identified as paramount for the perception of architecture. Strictly speaking, architectural space cannot be grasped solely through vision, hearing or touch, for these provide perceptual access only to individual qualities or elements within space. The perception of a situation within architectural space requires a comprehensive sensorium in which all the senses participate.

On the surface, perceptions of architecture are dominated by vision. Because the space of vision is most clearly structured, it is the basis for the articulation of the space of perception for all of the senses. It offers the kind of overview that the others senses cannot provide, and is translated most easily into an abstract spatial order and its objective representation. In contrast, the space of hearing is rather oriented towards the hearer's own body. While the directed > gaze identifies the elements of space, > sound is perceived through the sense of hearing – in a way similar to brightness or darkness through vision, or > odour through the sense of smell – as something that fills in and colours the space around us. Through the > haptic sense, we feel our own bodies in resistance to other bodies; the sense of touch brings us into contact with the > materiality of objects, and tends – in contrast to the distancing control function of the eye – to a more affective form of involvement. When the skin – our largest sensory

organ – brushes gently against a lightweight curtain, when we experience the chafing of a rough plaster surface or the rustling of an air draft, other modes of perception participate as well, via the other senses. Alongside noises and odours, we also perceive climatic stimuli such as humidity, temperature, and air pressure or airflow. Thus we distinguish between air that is dry and dusty or moist and muggy. Emerging via > synaesthetic responses are additional links between sensory modes, so that it becomes possible to taste even the smoothness of marble, as John Ruskin pointed out. But kinaesthetic responses are of special significance for the > experience of architecture, since that which is experienced via > movement and the movement itself influence one another reciprocally. Through proprioception, we perceive our presence in space and the position and posture of our bodies; in conjunction with our sense of equilibrium, we may experience certain irritations, i.e. the unease induced by inclined walls.

The physical data transmitted by our structural and spatial environment, its optical, acoustic and material qualities, are not simply processed as a mere manifold of stimuli, but instead worked up into ordered structures through preconscious mental processes of gestalt formation, through the laws and principles of form (Gosztonyi 1976, 820). Therefore, we do not have to project the solid forms and spatial structures into architecture, but perceive them with immediacy. Although the eye registers a wall surface seen at an angle, for example, as distorted, we grasp its true gestalt as a rectangle, without having conscious recourse to previous experiences or subjecting sensory data to a transformation. We do not simply see the form that appears on the retina; the features of the ‘perceptual form’ (Arnheim 1977/2009) also include the forces, tension and weight of forms. That which we experience as space does not simply correspond to physiological stimuli, nor to material or structural reality, but also represents an independent reality of experience, one that is structured primarily through > gestalts, > force fields and > gesture.

Through spatial experience, we reach out, figuratively speaking, by means of our personal space towards objects, and this > extension of our experiential space is decisive for perceptions of architecture. Contained within our perceptual space, moreover, are zones that are not perceived at a given moment, i.e. the space behind our backs or on the other side of a wall, into which directly perceived space is however integrated. *Literature: Arnheim 1977/2009; Gosztonyi 1976; Pallasmaa 1994, 1996; Seyler 2004*

Separation

> door and gate, ingress and exit, inside and outside, intermediate space, opening, screening, threshold, views into/out of, wall

Sequence

‘An architecture must be walked through and traversed,’ emphasized Le Corbusier (1962, 29). During a promenade architecturale, the individual should sense in her movement, ‘the result of a succession of shocks’. The principal feature of the sequence is linear succession, the way in which each element follows a previous one. But in contradistinction to the adjacency of objects or a succession of interesting perspectives and views, sequences are experienced as a characteristic > figure of movement. This also includes the interplay between the overall order and contrasting individual situations; the spatial context is always present. In fact, the sequence is not a progression from object to object, from one view to the next, but a switch between contrasting situations, which also encompasses changing mental states. The transition from a dark, confining space to a brighter, larger one is experienced as an expansion of the bodily sphere; the increase in room height as a stimulus to an erect posture; changes in material, form and coloration alter a room’s mood. The stages of the sequence in an outdoor space shift among other things with the gestural quality of the forms of public plazas or the at-

atmospheric character of urban quarters. Landscape sequences are based for example on the experiential contrast between views and valleys, open areas and dense forest.

The sequence (Latin: *sequor*, to follow) is distinguished from the > row through the variegated character of the succeeding situations. The individual segment is on the one hand a self-enclosed unit; on the other, however, it is conditioned by the non-arbitrary context and by the transition from its predecessor and to its successor. The basic condition for sequential experience is a minimum of variety, which singles out the succeeding situation as a new scene. The interconnectedness of the sequence is established by > memory, which generates linear mental images of processes of movement or activity. Just as the sequence is constituted by memory in the direction of the past, it stretches at every moment forward towards the horizon of expectation in relation to future perceptions, which are in turn conditioned by the experience of the spaces that have already been traversed.

In contradistinction to the > route, the sequence is heterogeneous, and contains points of discontinuity. In advancing from one spatial unit to the next, we do not find ourselves in the continuous situation of the route; instead, we relinquish one situation in order to seek out the next. Associated with every step is a sense of loss or of relief, and at the same time, surprise, or the redeeming of an expectation. In the simplest case, a first impression leads us to expect a specific quality in that which approaches. The second step may confirm this expectation, but may also contradict it in unexpected ways. In concrete spatial experience, one spatial segment transforms the next as a function of contrast. In a sequence of contrasting rooms, each individual room is experienced within the sequence differently than it would be outside of this perceptual succession. Adolf Loos exploited this phenomenon dramatically: 'When we emerge from a low room, a room of medium height seems tall. Nothing is either large or small, everything receives its significance through context.' (Kulka

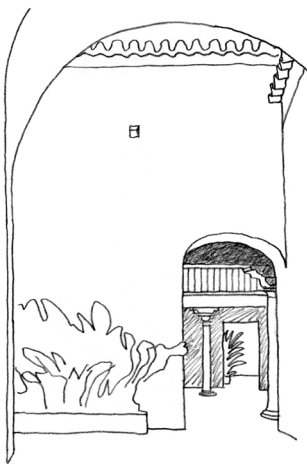

1931, 36) Every step can be deployed as a preparation for a specific climax within the spatial sequence, for the sake of dramatization – provided the sequence is subordinated to an intentional compositional principle.

A special form of sequence follows a constantly diminishing or increasing magnitude or scale. It may begin, for example, on an urban square, and lead via successively reduced degrees of > accessibility and heightened degrees of intimacy through a sequence of rooms and towards a private chamber. If a sequence beginning from the approach up to the interior of a house is arranged in such a way that each individual segments announce the goal to be attained, and is conceived as preparation for adopting an appropriate attitude upon arrival, we speak of an > introduction.

Literature: Blum 1980; Cullen 1961/1971

Servant/served space	> space-containing wall
Shadow	> arcade, cellar, darkness, light, space shadow
Shell	> incorporation, layering, poché, space-containing wall, wall
Shelter	> apartment, cellar, dwelling, floor, inside, postures, roof, warmth and cold
Sight	> closure, density, (spatial), enfilade, gaze, measure, perspective
Sign	Our environment is filled with signs, which confront us from all sides, often disguising the immediate experiential effect of spatial situations and shaping experience in general. In principle, all of the objects, elements and forms through which cities and buildings confront us can be conceived as signs. In one type of case, signs serve to indicate something, a specific form, for example, marks an > entrance, a building offers its silhouette from the distance as a physical marker that aids > orientation within a town, another building calls attention to itself through its emblematic design. In other instances, signs



transport > meanings that may lie outside architecture, so that their transmission relies on convention or knowledge. They may also be a 'self-image' (Arnheim 1977/2009) referring to particular features of a building, for example to its construction, its use, or its social status. In general, a sign is that which stands for something that is different from itself; a sign guides our attention towards a level of meaning that is located beyond sensual appearance. Where sign character predominates in architecture, its space-shaping and material palpability tends to recede into the background in favour, for example, of an iconographic level of meaning in medieval sacred buildings, or in a contemporary shopping street, where the spatial features of the architecture are appropriated by advertising, marketing, and commodity character.

According to semiotic theories, the sign's form and immediately perceptible qualities, defined as the 'signifier', refer to something else, to an object or a meaning, which is referred to as the 'signified'. As a rule, the link between the two is regulated by cultural codes whose acquisition is an aspect of socialization (> readability). In many instances, architectural form refers – in a way that emerges from the concrete situation – to a context that lies behind or outside itself; it does so for example by citing the forms of other buildings at other locations, by referring to historical events, by transmitting advertising messages, or by visualizing political programmes. The situation-dependent character of such semiotic processes, however, relativizes the unambiguous coordination of sign and meaning. Often, that to which the sign refers is itself the point of departure for further references, which may be prolonged in an endless chain. Superimposed upon a reference to a specific meaning (denotation) are to some extent diffuse subsidiary and additional meanings (connotations). Jörn Utzon's Sydney Opera House, for example, which denotes sailing ships and seashells in a picturesque way, also evokes connotations of floating lightness and demonstrative opening.

Without discussing the overlap between terms (colloquially, the term *sign* is often equated with the term *symbol*), the mode of reference that is especially characteristic of architecture for which the meaning of the form arrives at immediacy of > expression not only through a semiotic reference to something outside of itself, but also through > form character and > atmosphere, is referred to here as an architectural > symbol. Not unlike the > gesture, the > image, or > invitation character, this specifically architectural form of symbolism avoids the creation of an alienating remoteness from reality, i.e. when we switch from the real world of concrete signifiers to a remote meaning of the signified.

Basically, then, the spectrum of that which architecture is able to denote, represent or narrate, is unlimited. Architecture is distinguishable from other sign systems only in that architectural signs necessarily rely on their specifically spatial character, even when they – especially in pre-modern times – erect an encyclopaedic conceptual edifice.

Silence

> appeal, cellar, atmosphere, sound, sublimity

Simplicity

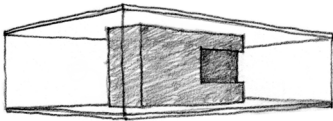

An intensity of experience in place of a multiplicity of stimuli can be heightened by spatial simplicity. In terms of Gestalt psychology, a simple > gestalt heightens the comprehensibility of the basic form, so that perception can focus with greater intensity on details. Simplicity opens up its value, however, only in ways that are complemented by > complexity.

Simplicity underscores the serving function of architecture, which provides an inconspicuous setting for everyday life – itself sufficiently burdened with confusion and variety. That which is preserved in architecture, enacted in it, is thereby positioned at the centre of attention. As a fundamental attitude, simplicity allows the situation of the *tabula rasa* to develop – as discussed in Walter Benjamin’s essay ‘Experience

and Poverty' (1933). A form of residence that acts on this maxim takes place in reduced spaces within which we encounter no traces that would be capable of cementing our habits and restricting ourselves and others, and in which 'it is difficult to leave traces' that might cement our habits and restrict ourselves and others. The ideal of this simplicity is to make it possible to begin from the beginning at any time without being predetermined by a history.

But in other contexts, reductive form can promote a receptivity to nuance at a heightening of differentiated perception, for example the concentration on proportions, surface qualities, or chromatic gradations, spatial qualities, which are not obscured by superfluous details. In particular, however, a simple setting – as a background – accords respect to that which transpires before it. When simplicity, however, is unsuccessful but merely simplistic, we encounter the danger of banality and clumsiness. In such cases, inadequacies are all the more strikingly evident.

Simplicity as the quality of a situation is not identical with simplicity of form: the practice of simplicity can mean, for example, wiping the slate clean – clearing off a table – to make a fresh start. More important than the simple, perhaps even empty room, as an architectural precondition for such a new beginning, is the availability of numerous cabinets and drawers where objects can be stored in an orderly fashion, allowing a truly clean sweep. Rooms devoid of unnecessary clutter create a context for rituals of concentration and restricted attention. Both the engendering and the perception of simplicity presupposes an intellectually demanding process, which establishes and maintains a simple > order in the face of the challenges and contradictory demands of a chaotic world. Oswald Mathias Ungers went so far as to base the ideal of simplicity in the abstract grasping and thinking of space, emerging only through a reduction to 'archaic clarity and simplicity': 'The architect builds so that he has something to think with.' But the philosopher Spinoza already remarked

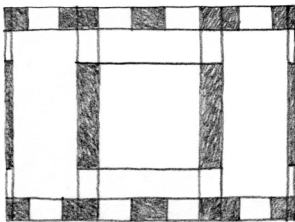

at the end of his *Ethics* that the simple, the transparent, is at the same time the most difficult thing of all: *Sed omnia praeclara tam difficilia, quam rara sunt*. ‘All things excellent are as difficult as they are rare.’

Situation

We experience architecture in the form of situations. The Latin term already establishes a relationship both to architecture (Latin: *situs*, constructed, situated, providing residence or dwelling), and place (*situs* also means geographical location, area). Situations contain humans and objects; the term *architectural situation* refers mainly to occupants and their homes and rooms. The texture formed by the situative and contextual relationships that joins them is conditioned by the respective ‘situatedness’.

The way in which we experience a given situation depends substantially upon our current motivations. According to the frame of action, pertinent interests, or point of view, one and the same spatial configuration will represent very different situations; a residence may be experienced, among other things, as a building project, a home, a rental or sales object, or a work of art. We experience a situation as architectural by virtue of the way in which it noticeably shapes the spatial conditions of our movements and activities. The performative character of the situation is therefore a decisive component of the architectural > concept.

However, between the diverse > meanings and motives that define a situation, there generally emerge superimpositions, divergences or interlocking structures, so that an ‘architectural situation’ mostly overlaps with other conditions that shape situations. The situation of a work station, for example, may also incorporate the situation of the view from a window, thereby bringing factors such as stimulation or distraction into play. On an urban square, the situation of a political demonstration may overlap with the situation of confinement or > enclosedness of the square, in turn contributing to a heated

mood, and conditioning the audibility of shouted interjections.

Relevant alongside the multiplicity of intervening elements and factors when architecture is described as a situation is their performative character, which incorporates the processual and eventful qualities of the respective situation. As a rule, situations are not experienced in purely static terms, but instead through movement and active participation. Descriptions of situations do justice to this factor only when it grasps architectural elements in relation to use, to our multifaceted intercourse with them, when the relationships and positions we adopt in relation to them are taken into account, along with the gestures they evoke. Decisive in the case of a row of supports is less its form, and rather the way in which they contain us, allow us to pass through, or guide us, while for a > staircase the experiential possibilities of ascending and descending are essential. When architecture is registered as a holistic and integrated situation against a diffuse background of sensory stimuli, we may perceive it as an architectural > image. Because we ourselves are components of this situation, however, we experience it simultaneously as a > scene within which we appear before ourselves, so to speak.

Size

In architecture, size is addressed both to the understanding as well as to feeling. The understanding grasps size as quantity and > measure. Of course, it cannot grasp spatial dimensions directly; these become palpable only by being measured against a familiar unit, which must be perceptible as a fixed reference point. In the realm of feeling, comparisons are not based on the quantitative; instead, the size of a building is perceived in relationship to one's own body, to objects in the vicinity, and in the framework of a total situation (> scale). The appropriate size of a room is dependent upon the requirements for proximity and distance between individuals, and is appraised variously according to its articulation into places of activity.

A large building may seem large despite – or even precisely by virtue of – the narrowness of the setting, yet it requires adequate clearance in order to be grasped as a whole. A Doric temple seems larger on a bare elevation than it does in a city, as part of the ensemble of large buildings. Since the distance required to view buildings is often blocked in urban contexts, a large building often requires a specially designed plaza in front as an open space, which accords respect to its overall size. Since it is often impossible to grasp a large building as a whole up close without raising or pivoting our heads and gaze, we are often consigned to a scanning mode of perception. Extremely large three-dimensional objects, then, are constituted perceptually through movement. In general, when we scan individual form elements, a fine articulation allows a building or part of a building, for example, the fluting of a Doric column, to appear not only delicate, but also larger, while forms having larger articulation, conversely, appear smaller, yet at the same time coarser. When the eye feels its way gradually from smaller to larger units and finally towards the whole, a sense of size is built up bit by bit through inner relationships. ‘One might say that we see the building not simply as having size but as acquiring it (...).’ (Arnheim (1977/2009, 131) Through this structure of divisions, even buildings with minimal dimensions may gain a certain stature as > monuments.

Monumental effects of size, however, that are intended to overwhelm, cannot be arrived at simply by continually increasing the volume of a building. According to the law of allometry, the surface does not grow in a commensurate fashion. This has peculiar consequences for the relationship between the walls and the space, as we learn through a comparison between buildings with large and small volumes: given the identical wall thickness, the walls of a large room seem weaker than those of a small one. At the same time, they seem to constrict the space, because they are able to contain its disproportionately large volume only with effort – even though,

on the other hand, freedom of movement is actually greater (Arnheim 1977/2009).

Because the impression of architectural size cannot simply be equated with sheer dimensions, such effects are generated through special architectural measures, which are designed to avoid falling into banal gigantism. Étienne-Louis Boullée recommended making the parts of the building as numerous as possible in order to generate sensations of immensity. He counselled, for example, creating sensations of limitlessness by using rows of columns, which continued in all directions and extended so far that it became impossible to count their elements, or extending avenues to such lengths that their termini were no longer visible. The individual is meant to be unsettled by effects of sublimity (> sublime) that are generated by the size of that which has become incommensurable. He enthused: 'An image of grandeur pleases us in every regard, then it is our nature to strive to elevate our sense of life, to encompass the entire universe.' (1987, 58)

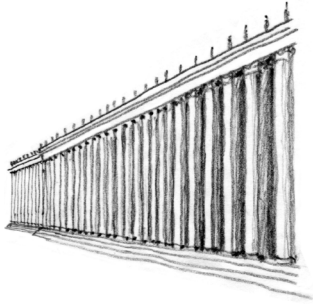

Only in Modernism has expansive scale made possible by technology become an everyday phenomenon, as seen in skyscrapers, airports, fairgrounds and railway stations. According to Rem Koolhaas, size has its own laws, which call into question or even render obsolete earlier architectural criteria such as the object's composition, scale, proportion, detail, legibility and comprehensibility, along with the importance of context: according to Koolhaas, size supports the principle of heterogeneity and complex superimposition, and heightens the autonomy of the individual parts. For him, however, this by no means entails fragmentation. The pulling apart of core and envelope is extended to the point at which a structure's interior is no longer legible from the outside. The requirement of > readability and veracity is hence suspended. Interior and exterior assume separate tasks: the object's apparent stability must be communicated towards the outside, while within, it becomes necessary to master the instability of complex programmatic and design requirements. The large spatial object,

then, follows its own logic, and even eludes the traditional texture of urban and contextual relationships. It becomes a city in itself, and hence no longer needs the city.

Literature: Arnheim 1977/2009; Boullée 1987; Koolhaas 1995

Slab

> closure, flowing space, plane, wall

Sound

The sense of vision dominates our perceptions of space, easily displacing the role of space acoustics for the experience of architecture. But spatial acoustics is especially well suited to endowing spaces with a unified and incisive character, of connecting them to and distinguishing them from one another. The most intense effects of acoustic traits in architecture, meanwhile, operate at the atmospheric level, shaping the moods of spatial situations subliminally in astonishingly powerful and comprehensive ways.

Differently from the space of vision, which offers an overview, the space of hearing is in many instances diffuse and dispersed on all sides. The sense of hearing has no fixed direction that is comparable to the axis of vision; we can hear around corners as well. When spatial divisions are recognizable, for example the origin and directionality of the sound, or its rough distance, they are oriented in relation to our bodies, and are ordered within the space of vision. Sound does not offer a spatial sensory field that has the same precision as the visual one, but is experienced primarily in temporal terms. As the dynamic trace of events, a sound fades away if it is not constantly generated anew. Moreover, tones possess certain intrinsic qualities that allow them to become spatially effective as well, for example the heavy, broad character of deeper tones in contrast to the pointed sharpness of higher ones. While a pure tone or diffuse soundscape tends to become independent, some noises refer to concrete spatial traits and objective circumstances.

By virtue of its form, size, surfaces and materials, every built space has a specific ambient sound. This is influenced by reverberations, reflections, the selective amplification or attenuation of certain sound spectra, allowing it to sound harsh, muffled or sonorous, thereby endowing it with an integral character that is not communicated through differentiated vision. Through our movements in space, our step on the flooring, the sounds we make when opening a door or through other activities, the sonic traits of a room are activated via the various vibration behaviours and the resonance of materials and surfaces. The characteristic acoustic traits of a building, its vibrations, the creaking of beams, the whistling of the wind etc., and the sounds produced by individual elements, i.e. the whirring of an elevator, the falling shut of a door, or the rustling of curtains, contribute to its sonic character, as does the immission of various locally typical noises. Rooms can be distinguished, divided and zoned on the basis of various sound characteristics. Through contrasts, acoustic characteristics can be enhanced, for example when a room with muted acoustics suddenly opens into one with marked reverberations, or when we step from noisy surroundings into a quiet room, so that our own steps underscore the effect of stillness.

Conveyed via > appeals, contents such as intimacy, sobriety or sublimity are transported together with sonic character, and corresponding forms of behaviour are suggested. The typical acoustics of church interiors, for example, in conjunction with their reverberations and lighting schemes, shape the situation as a whole, demanding appropriate forms of speech (or song). In outdoor spaces, the sonic design resources of garden and landscape architecture include the crunch of gravel, the babbling, gurgling or murmuring of water, the rustling of leaves from various types of trees. Urban spaces, passages and streets, as well as entire city districts, towns, landscapes and regions have their own acoustic characters.

Sound is capable of linking spaces, of creating connections between inside and outside via the walls and their open-

ings, between above and below via ceilings and floors, as well as through the transmission of structure-borne sound through the permeability to sound of spatial delimitations. Whether such connections are interpreted as deliberate communication (calls, admission), as tolerated noises, as a welcome sharing of the lives of others, or as a disturbance, depends upon cultural and social framing conditions. Such disturbances can be minimized by means of homogenizing noise-masking.

Alongside the concrete spatiality that we perceive via sonic phenomena, it is in particular the > atmospheres that are generated by sound that result in intensive experiences of architecture. Through sound, then, we do not perceive something definite at a distance that is really present; instead, we are enveloped, permeated by sound, whose identifying traits retreat now behind its primarily subliminal and atmospheric impact. Despite the influence sound has on us, we are often completely unaware of its existence, noting its presence only retrospectively, or when our attention is called towards it.

The dominance of vision makes it difficult for us to assess or evaluate the role of sound for situative effects (this parallels the subliminal effect of > odour); it affects mood surreptitiously. The enumerated indicators of concrete spatiality too play an unconscious role in creating atmosphere. The hard sound of steps on a stone floor not only conveys information about its materiality; the regular resounding of the sharp tones seep into the unconscious, colouring and permeating the entire situation and stealthily enveloping us in a mood that is all the more inescapable because the force remains mysterious. These moods too can be shaped through architectural resources. Our lack of control over the emotional effects of such perceptions, however, renders us vulnerable to the manipulation of emotion through subtle streams of sound.

Literature: Schafer 1988

Space

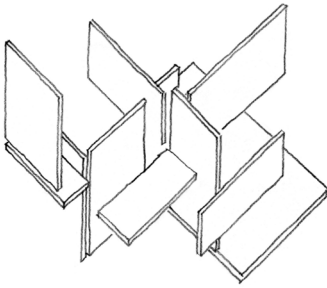

It has been asserted that architectural space is a fiction (Feldtkeller 1989). Since space is not immediately accessible to sensory perception as such, it is in fact quite difficult to describe, perceive or inspect architectural space. In reality, it is through structural elements that architectural space comes into existence. We see walls, floors and ceilings; in terms of intentionality, however, we experience them as space. In fact, the fascination of architecture consists in ‘its ability to render the inherently ungraspable phenomenon of space at least somewhat graspable for human imagination.’ (Meyer 1998, 349)

It only becomes possible, however, to define architectural space once we have specified that which comprises the architectural as such (> architecture). For a century or so, space has been regarded as the central concept for architecture and space design, as representing their content (Schmarsow 1894). Still, space is not the medium of architecture as such – the significance of the term is far too general to specify the architectural. Hence the justified warning against a fictive notion of architectural space. The conceptions of *space* that are – among numberless definitions – of significance specifically for > architecture relate first to the objectivity of real, built spaces, secondly to the experience of space as a complex > situation, and finally to the two in conjunction, to the intellectual > concept of a space that is contained in a design. According to Hans van der Laan (1983), architectural space is grasped in ‘physical’, ‘sensory’ and ‘intellectual’ terms.

The medium of architecture is not simply space as such, but the differentiated enclosure and articulation of spatial areas for the sake of movement or for stationary utilization, and in general for facilitating the unfolding of human lives. Architecture undertakes this enclosure and articulation not in a purely semiotic way, but through the structural establishment of spaces that are delimited as units from space in general. Nor do rooms physically consist of space as such, but are instead produced through structural elements that

delimit, shape and link spaces together by means of openings. In China and Japan, this phenomenon is referred to as *ma*; according to this principle, spaces and places acquire their nature from the in-between, from the emptiness between graspable, material elements. While space derives its value from emptiness, structural elements – even when they are flat – possess bodies (> body, architectural) that consist of mass. Thus the empty space essential for rooms is produced through its complementary relationship with these bodies.

If we consider the spaces between bodies and those within bodies as a unified medium, then we speak of a ‘continuous space’ (Hoesli 1997), or of the > space-body continuum of architecture. But built space is not spread out in front of us as a separate reality; instead, architectural space encompasses structural elements and inhabitants alike as a total situation. Space – as it is explicated by various theories – appears in a multitude of ways. Decisive, for example, is the notion of space as an expanded sphere of the human > body, as a spatial volume that serves as a radius of movement. The expansion of perceptual space is dependent upon the materiality of spatial delimitations, which provides stability to the range of the senses and the > extension of > personal space. In perception, we experience space not as neutral, but as influenced by > force fields. Since > movement is an essential moment of architectural experience, our scope of movement – which we experience through kinaesthesia – plays a special role. If space is regarded as a texture of > places, then its > routes become a connecting network of places that constitutes a hodological space (a route space). From the perspective of > use, the space of action appears as a system of spatial positions that are important for action. It is extended in the social and political realm, which emerge through the actions of people and their social interrelations. The > atmosphere which permeates in architectural space converts it into an atmospheric space. All of these conceptions of space, despite their different emphases, share the way in which the relation-

ship between space and occupant is not conceptualized as one between container and contents, but as one between > scene and actors. Architectural space belongs to that which Karlfried von Dürckheim referred to as ‘lived’ space. In this way, architectural space is essentially perceptible as spatiality, as a sphere that we generate only through our life processes in interplay with architecture.

Architectural design mediates between built reality and situative experience. That which constitutes architectural space, consequently, is also displayed in the meticulous character of the > spatial framework. Both the design constitution and the intellectual apprehension of a spatial > order presupposes an intellectual > concept. According to Philippe Boudon (1991), the object of architecture is a ‘mental space’ whose transfer into built space is regulated by > scale.

Literature: Dürckheim 2005; Gosztonyi 1976; Kruse 1974; Meisenheimer 1964

Space acoustics

> sound

Space-body continuum

Architecture is an interplay between mass and cavity, full and empty, > body/mass and > space. Bodies/masses are perceptible only when they stand out against unformed space. A space requires figural qualities only when it is formed by the contours of bodies. But space and bodies not only stand in a complementary relationship to one another, they also merge into one another in a continuous fashion. At least initially, the distinction between them seems clear: a body is turned outward as a convex figure, the space, conversely, is concave, inward-directed (> concavity and convexity). But architectural masses contain space, and – in conjunction with others – form spaces outwardly as well. ‘Architecture is the art of designing spaces through the designing of bodies in *dual* ways.’ (Schumacher 1926, 28)

The space-body continuum can be illustrated in relation to the dual role of the surface (1), through the reversal of figure ground relationships (2), and through the transition from one scale to another (3).

1. The > surface plays a decisive role, since a (concave) interior side can become a (convex) exterior side, and vice versa. The concave inner side of a room, for example, often displays convex areas, which protrude out into the space, i.e. projections or columns; concave areas, in turn, may appear on the exterior of an architectural body, i.e. recesses or niches, which contain external space. Even when a building, in conjunction with others, forms the concave contour of the contained outdoor space of a > courtyard or > square, there is an interplay of concave and convex forms whose mediating element is the surface, which is shared by both architectural mass and spatial figure, and which forms the outer limit of the one and the inner side of the other. In a kind of ‘contour rivalry’, both lay claim to the surface of this common boundary, which can be perceived as continuous, although the balance between concave and convex may be reverse quite abruptly, for example when one moves around the ‘body of the building’, which in turn delimits a public square with its wall.

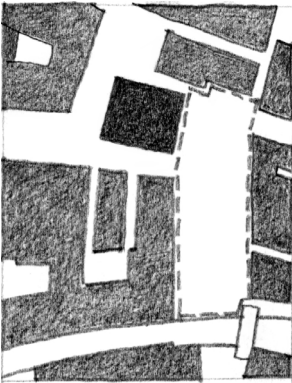

The dominant figural quality is assigned either to a body or to a spatial form. If the body/mass figure dominates, the *Prägnanz* of the surrounding spatial gestalt is reduced; one can tell from the outside of a body/mass when it contains an incisive, inner spatial gestalt. If the body/mass figure, however, is reduced to its role as a spatial contour, the body/mass gestalt is deprived of *Prägnanz*, and the body at most contains subordinate spatial units in the form of a > *poché*. One can readily imagine architectural forms that are ambivalent or remain indecisive in this respect, which are both body/mass figures and spatial contours, or neither (*chora*), for example the L-shaped forms from which Peter Eisenman (1989) assembled his *Guardiola House*: ‘It breaks the notion of figure/

frame, because it is figure and frame simultaneously, (...) the material of the house, which neither contains nor is contained.’

2. As a rule, urban development forms the homogeneous ground of the city, in particular the texture of residential and workplaces, from which the > gestalts of individual buildings or spaces, e.g. > monuments or prominent public squares, are set off as figures. In the space-body continuum, this figure/ground relationship is reversed. We find neither a continuous background, nor a clear dominance by the figure of either body/mass or space. Observable instead is that which Aldo van Eyck has referred to as *reciprocity*: the one is reached with the help of the other. In representations of the spatial structure of urban planning, reciprocity is expressed through a figure/ground layout in the style of Giambattista Nolli’s plan of Rome. Depicted (in white) within the structural mass (black) are public interiors, as well as squares and streets. In a church interior, for instance, one remains at the same time within the object (black) and in space (white), while the design of the interior walls frequently resembles the articulation of the facade. Often, squares and interiors are endowed with higher design *Prägnanz* than structural features themselves. In a ‘through-layered’ (Hofer, 1979) urbanistic structure, object-figure (black) and spatial-figure (white) are superimposed. In them, the square and street realms are not set off from buildings by a sharp contours; instead, the ambivalent assignment of black and white in the figure/ground layout corresponds to the fundamental possibility of adopting a position within the architectural body, and simultaneously in an interior or exterior space (> transparency).

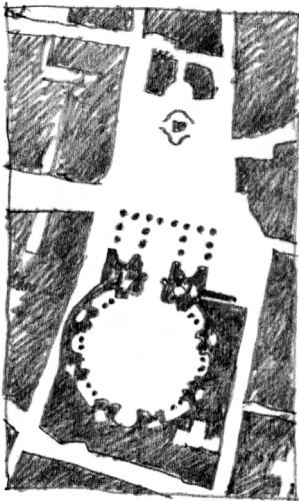

The principle extends from the urban planning dimension all the way to the scale of interior architecture, consisting of wall niches and recesses, window reveals and door jambs. Constructive parts and spatial units that can be designated in multiple ways allow the corresponding experience to be especially vivid. As a consequence, rigid divisions – according to which outdoor spaces are found outside of architectural struc-

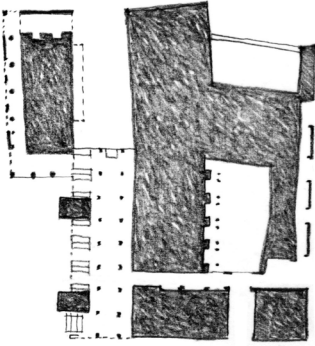

tures, and interiors within them – are broken up. Passages or > arcades, for example, verandas, > galleries or courtyards are > intermediate spaces within architectural bodies; they are not sharply delimited by outer walls, but only partially built around/over, or only partially closed due to the presence of perforations, which lie half inside and half outside. This is accompanied by flowing transition between the public and private character of these spatial intersections.

3. An additional type of space-body continuum becomes recognizable through the relationship between various scales. On the uppermost scale, the cityscape is a figure surrounded by the open landscape, a phenomenon that is displayed especially incisively in the military fortifications of historic towns. On a smaller scale, gardens, squares and streets constitute the outer spaces that serve architectural ensembles – whether urban blocks or freestanding > monument – as a background. Within a complex, in turn, a courtyard constitutes the outer space that confronts an individual building or structural component. Within a building, this sequence continues, as individual groups of rooms alternate as bodily masses with empty spaces through > incorporation and > inversion. The individual enclosed rooms and spatial complexes in their various dimensions always emerge simultaneously as bodily masses and in relationship to one another. In traversing the city and its buildings, passersby shift from scale to scale between architectural bodies and spaces.

Literature: Hoesli 1997; Hofer 1979; Merrill 2010; Schumacher 1926

Space bubble

> personal space

Space-containing wall

If a > wall is sufficiently thick and contains cavity spaces, objects may be stored in it, and it may even accommodate human activity. Between its inner and outer wall surfaces, a

space-containing wall contains chambers, niches or small ancillary rooms, which not only appear as > porosity, but also transform the wall into a space. Besides being the boundary of a space, it can itself be fashioned into a cavity through hollowing out, > layering or > folding, rendering spatial boundaries soft or indistinct, or staggering them into > depth. The spectrum extends from the plastic modelling of a wall relief with small niches all the way to the recesses of a multilayered wall that contains loggias, bay windows, > galleries or > arcades. In the simplest instance, an interval between two wall layers is formed by doubling. Either side of the double wall can be more or less perforated or dissolved, thereby opening itself up in various ways to adjacent spaces. Through the varying shaping of the contour on both sides, the hollow spaces too alters its form.

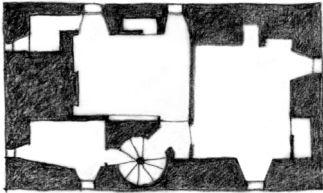

Because the space-containing shell also has its own mass and volume (Rudolf Schwarz refers to it as a 'crust'), it is simultaneously wall masses and wall space (> space-body continuum). In addition to space-containing walls, other structural elements such as supports or ceilings maybe also regarded as space-containing, provided they offer usable or accessible cavities.

The cavities of space-containing structural elements represent a further type of space that lies between interior and exterior, and generally has the character of an > intermediate space. It belongs simultaneously to the inside and the outside, but forms neither a flowing spatial transition nor a division; it has a complementary function for both sides. Towards the outside, the space-containing wall mediates between the interior of the building and the outer space of the city (> facade), establishing formal transitions, and offering spaces that lie half-inside, half-outside. For the interior, it is generally assigned to a 'servant' spatial zone of a principal room, which it 'serves' from the periphery. This hierarchical relationship between 'servant and served spaces' is well known as a characteristic of the architecture of Louis I. Kahn. In this position,

the space-containing wall provides an access or maintenance area, for example, or can be used for storage or retreat. Or it accommodates a lighting scheme, as in many variants of the Baroque spatial shell. But it also enhances perceptions of the spatial shell as > screening or spatial buffer (> space of resonance), or enhances a space's introversion through the cladding of the shell. To the extent that a space-containing wall contains mass as well as space, it also – as a > poché – facilitates formal mediation between neighbouring rooms.



Some wall cavities correspond in position and form to projections of the human body. Built-in seats, for example, offer the possibility of sitting within a wall, or alcoves provide a niche in which to recline. The elevation of the hip-height sideboard corresponds to the region of the human grasp. An individual's > personal space can expand into the cavity of the spatial shell. When carried to its logical conclusion, everything we require would surround us in the walls of the house. Wherever we extended our reach, the space-containing walls would respond the appropriate service. The result would be a house, all of whose ancillary and functional rooms would be accommodated within the walls. The space-containing wall can be conceived, then, as a plastic, yielding mass that registers the spatial requirements of occupants as a negative impression through traces of > use. That which is found in niches, built-ins and plastic extensions is stored in > memory during continuous life-phases.

Literature: Alexander et al. 1977; Stephan 2009

Space height

> ceiling, ground, hall, Raumplan

Space shadow

Every building has its own spatial zone of influence, one comparable to a cast shadow. By analogy with the shadowed area formed by a building against the light, this area of influence is referred to as a *space shadow*. Just as the essence of shadow is

more than the absence of light, but also the constitution of an independent spatial zone, space shadows too generate their own spatial spheres. Just as the inherent and cast shadows falling onto walls and floor surfaces indicate the concave delimitations of a spatial volume, the facade of a building casts – figuratively speaking – a space shadow onto the surface of the ground lying before it. The effect is that of a > force field in the area of influence of the wall that casts the space shadow. The shaping of architectural spaces begins with the combined effect of two planes that form an > angle; accordingly, wall and floor together enclose a concave angle, and hence a spatial volume. An approximate notion of the extension of this zone is provided by a figure that shows the vertical outer wall of a building folding out and downward onto the surface of the ground before it. Delimited by this zone of influence that coincides with a shadow, despite the indistinctness of its contours, is a volume into which one can become immersed, can remain as though in a shadow. The influence of building and facade on this volume has the character of a kind of radiance. Just as the wall of a house that is warmed by the sunlight during the daytime continues to radiate warmth into its surroundings in the evening, the facade of a building transmits something of a building's space-shaping force to its immediate surroundings. When a space shadow lies not in darkness, but is illuminated by sunlight, then, the entire spatial volume is warmed by the heat energy of the wall. In addition to temperature sensitivity, the acoustics of such zones of influence are often shaded by various types of sound absorption or reflection.

Depending upon one's orientation and position within this zone, the wall provides rear cover or leads towards > confrontation; it offers both virtual and real types of support, proximity, stability or protection. As foil and background, the wall becomes a projection surface for going on, for people within this front area, the space shadow becomes a > scene. The concavity of the space shadow is reinforced

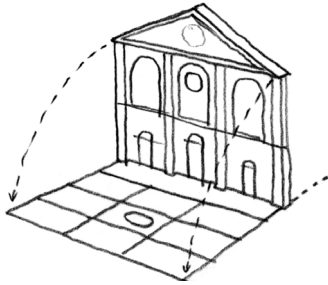

through overhanging roofs, projections or niches; its outer edge may be framed by steps or low walls. The projection of the facade into this front area is supported by a corresponding division, for example that between the Cathedral and the Piazza Communale in Pienza. In the event that a > facade is intended for a specific effect, the space shadow provides its framework. If the facade in question is not flat, but fronts a circular building, for example, then the radiance of the area of influence extends on all sides, forming a radial force field that presses outward and has a repellent effect, one that diminishes with distance.

Space-time relationship

> time

Spatial density

> density (spatial)

Spatial envelope

> closure, covering, filter, incorporation, screening, tectonics, transparency, wall

Spatial structure

Generally, every space is perceived as a part of a larger whole; within which the spatial structure determines the arrangement and connection between spaces. The well-considered joining together of the parts into a whole is a constitutive quality of architecture, which receives its expression in the > composition as a result of an intentional design process (> concept). Recognizable in this composition is an architectural > order, when the spatial structure is subordinated to a comprehensible and rational rule. Many spatial structures that have been established through history are represented by architectural > types. A spatial structure is always a structural component of a larger situation; it becomes possible for participants to determine their positions within the structure, and to organize their actions, either incorporating themselves into the structure, or exercising an influence on it.

The resources of spatial assembly are based on simple connections and configurations developed from them. Rooms

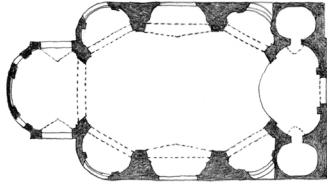

may be disconnected, and related to one another solely through similarity, contrast, or the complementarity of their forms. Or they are connected with one another, in which case the connections are distinguishable according to the positions and sizes of > openings, changes of direction, bifurcations or > joints, and may be varied by special treatments of assembly through framing, jambs, spatial buffers, or mediating > poché. Where spaces interpenetrate, connections are often barely perceptible, for example, in > flowing spaces, or through the Baroque fusion of central and elongated rooms.

Finally, the internal articulation of individual rooms constitutes a form of spatial structure, for example in zoning by means of varying room heights, or > space-containing walls and the combination of ‘servant and served’ spatial units, as in the architecture of Louis I. Kahn. The optimal use of spaces is not dependent upon surface area in absolute terms, but upon differentiated articulation, the admission of various interpretations, foci and modes of appropriation. Skilful subdivision can make rooms appear more spacious.

In the configuration of a spatial structure, the relationship and subordination of spaces, the plan plays a decisive role. For each storey it prescribes the spatial linkages as a kind of choreography, it guides the movement of occupants, and interlinks individual places into a coherent whole. As the embodiment of the compositional intention of the design, the plan gives stage directions, so to speak, for organizing the building’s > use, regulating the division and cohesiveness of utilizations and assigning the various activities suitable spaces.

But in addition to the plan, the spatial structure also encompasses the distribution of rooms on different levels. In this regard, the form of vertical > access is a key figure; the striking structure of a staircase is capable of rendering a building’s spatial order comprehensible. With the spatial structure of Adolf Loos’s > Raumplan, a sophisticated interleaving in height becomes evident through the options it offers for overviews and perspectives.

A characteristic feature of many spatial structures in architecture is a hierarchical relationship between accessing and accessed spaces, which are joined on various scalar levels: the room within the apartment, the apartment within the building, the building within the city, and so forth; most simultaneously provide access and are designed to be accessed. Corresponding to each level are duration of stay, degree of closure, and specific forms of activity. The system of movement spaces too – which includes streets, routes and corridors – forms such a hierarchy. This ‘cascade of levels’ – which extends through all scales, from the spaces of the city down to cabinets and drawers within a room – is regarded by Dorothea and Georg Franck (2008) as the ‘quintessence of architectural space’. Hence, spatial structure also serves the function of > accessibility, whose measure, according to Bill Hillier, resides in its ‘depth’. This determines the number of rooms that must be traversed before the structure – i.e. from the entrance to one’s own room – has been fully penetrated.

The orientation of the spatial structure in relation to concrete activities and social relationships (i.e. the distribution of individual or common rooms within an > apartment) is decisive for our experience of architecture in use alongside formal principles of order (i.e. > centring (radial, ring-shaped), the > sequence, grid or stack, or free grouping).

In contrast to the geometric composition of a spatial structure, an ‘organic’ architecture that develops from within, as advocated for example by Hugo Häring, has its point of departure ‘in the living processes of dwelling’. Its movement sequences are compassed by the spaces in such a way that they are able to unfold freely. ‘One gathers the walls around a residential grouping; one does not order residential grouping into rectangles.’ (Joedicke/Lauterbach 2001, 80) According to this idea, the building fulfils its function like a human organ.

Square and street

Squares and streets are the interior spaces of the city. Just as the solid masses of the walls enclose interior space within a building, the buildings lining squares and streets enclose these spaces within the urban setting. In a relationship of figure and ground, it is not just striking buildings that emerge from the homogeneous urban texture, but given sufficient density, the incisive figures of squares and streets as well. Through individual structural character, they give a town its unmistakable identity. In many cases, the historical significance of a place makes them into monuments, thereby acquiring significance as places of public life within the town, as settings for present day activities.

Generally speaking, public squares are not enclosed by a continuous spatial boundary, but only partially framed by buildings, between which are found gaps. If it nonetheless becomes possible to speak of a square, then this is due to the perception of a gestalt, one that is completed as a fully present contour optically across such gap areas. The gaps may be neither too large, nor too deep. Radial street junctions, for example, form wide, open holes, while angled streets, by contrast, capture the gaze from the interior of the square, ensuring its enclosedness. The front facades of squares and streets can capture the gaze by broken sight lines, either laterally or in height, in such a way that the space is temporarily closed, only to open up again upon closer approach. A comparable effect can be attained through staggered street junctions at intersections.

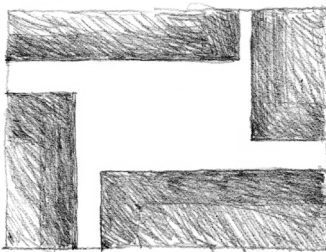

Only in a densely developed city are the delimitations of squares and streets formed primarily by the fronts of buildings. In other instances, hedges, walls or closed fencing form half-height spatial boundaries, with eye level serving a critical function for the effects of enclosure. Steps, edges, gutters and low walls only indicate spatial boundaries. Rows of trees may replace the contours of a square or plaza, yet in most cases, they have a veiling effect, or double the boundary formed by set back building fronts. As avenues, they suggest comparison

with the rows of columns and their guiding function in a basilica; this is even more the case for double-sided arcades. In the form of the urban loggia, the columned hall and the space of the square tend to merge. Illumination, finally, also participates in the formation of outdoor spaces, for example when lighting elements set at a uniform height to feature a rooftop, when light cones exclude areas, when zones are divided by islands of light and shadow, or when specially lit buildings facilitate orientation or serve as sources of > space shadows.

While disciplining through the construction conditions a regular form of the inner spaces of the building, the free forms of streets and squares are derived from their interleaving with the respective structure of development. Their irregular and often unplanned shapes arise more or less incidentally as intermediate spaces between architectural masses, but they are instead often designed as a differentiated response to perceptual demands. As a forecourt, for example, the area of a square may serve as a deference zone in front of an important building, allowing us to retreat; the square may be delimited as a concave framing shell within which a building is integrated as a convex form, one instance being Santa Maria della Pace in Rome. Or a square may resemble a stage upon which the building appears, an example being the church of Santa Maria Formosa in Venice, which turns itself inward effectively from the side into the Campo of the same name. Squares and streets are places where important buildings encounter one another, often confronting one another frontally, as do Weinbrenner's Stadtkirche (city church) and the Town Hall on the Market Square of Karlsruhe. Through their > directionality, according to Camillo Sitte (1889/1983), an elongated square, for example as a 'deep square', is oriented towards a certain building front on the narrow side, or as a 'broad square', towards a main facade on the broad side. L-shaped squares present a building from two sides, while articulation into a main and ancillary square allows elements of the building and parts of the square to interpenetrate, so that various

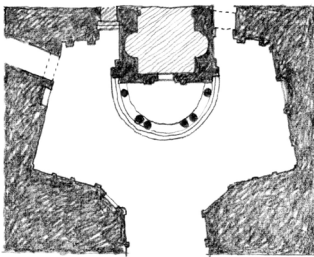

> facades of the building receive their own forecourts. At times, the interplay of figure and ground results in a patchwork of multiple buildings and squares alongside one another, for example those arranged around Salzburg Cathedral. Rudolf Arnheim (1977/2009) characterizes the relationship between the centrifugal force of expansion exercised by the figure of a square, and the counterforce of the architectural masses that delimit it, as a sensitive balance. The spaces of intimate squares with an enclosed character and minimal size have the effect of ‘urban rooms’, yet require a minimal extension if they are to assert themselves with sufficient counterforce as spatial figures against the masses of the delimiting structures. Conversely, an excessively large square sacrifices its coherence when the edges are too weak in relation to its extension. As a rule, the Prägnanz and force of extension of a circular square is so strong that the surrounding contour offers only passive resistance (> force field). By virtue of its distinct > concavity, a rounded form offers the greatest degree of closure. The concave spatial effect is strengthened in section when the ground slopes down towards the centre and large roof overhangs gently enclose the space from above as well. If the > ground of a square arches upwards, it offers a special form of resistance to those stepping onto it. A square or street zone is experienced as an > interior in particular when the facades bear traces of occupancy, like the walls of inner rooms, or when the pavement, set with > ornamentation, resembles a carpet.



Unlike the interiors of a building, squares and streets flow into one another, and serve movement between urban spaces rather than inviting us to stay in one place. Decisive for their forms, then, is the way in which they link movements with one another to form > sequences. The upbeat to historic sequences of squares is often formed by those which originally marked entrances to the town, and set directly behind the gates, an example being the Piazza del Popolo in Rome and the Königsplatz in Munich, or waterside squares such as the Piazzetta in Venice and the Piazza dell’Unità d’Italia in Tri-

este. As forecourts in relation to the city, they are significant as > intermediate spaces in ways analogous to the lobby of a building. Further on, sequences of squares and streets form units that interpenetrate or are separated from one another, to some extent, forming > joints, and determining the > dramaturgy of the urbanistic spatial structure through contrast of size, form and character. Separations and transitions between spaces are formed either by narrow passages between the edges of buildings that are comparable to gates, or by more or less flowing connections. Through > gesture, squares with irregular shapes suggest a particular mode of traversal. In some cases, the buildings lining the square do not form a distinct spatial container, but block the gaze only temporarily, guiding it in a new direction through skewed positioning as soon as it is reached, thereby leading movement towards the next spatial unit. In other cases, routes lead into and out of the square in a continuous flow along a facade front, or streets allow a square to flow out at the corners, thereby embedding it into the continuing street network. Streets, in turn, are divided into closed spatial segments when building alignments curve or bend, when they create narrowing, or are staggered in relation to one another. The art of arriving at lively spatial articulations via such resources was mastered in particular by Theodor Fischer, whose town planning for Munich was intended to achieve a specific 'movement form' (1934).

Squares and streets are the spaces of public life within a city, and at the same time public thoroughfares. They must therefore be designed in such a way as to accommodate a range of functions and activities, and in particular to be fit for incidental encounters through movement. To be sure, the segregation of zones for motorized traffic and for pedestrians respectively facilitates the unhindered movement of both; in shared spaces, by contrast, laws and conventions are replaced by eye contact and mutual consideration. Instead of the separations of areas through kerbstones and the channelling of traffic along standardized lanes, appropriate behaviour is fa-

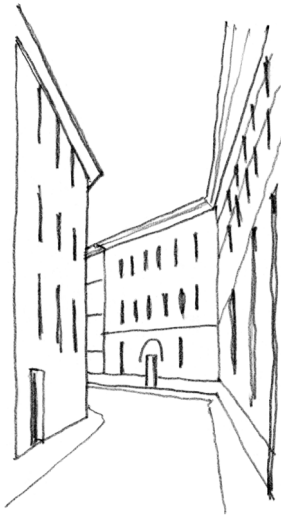

cilitated via an > orientation towards the total spatial situation. As a consequence, the architectural features of such urban spaces advanced more strongly into the foreground. In place of conventional signage, stopping places, zones of movement, and directionality are indicated via the direct expression of their spatial gestalt.

Literature: Cullen 1961/1971; Janson/Bürklin 2002; Rauda 1957; Sitte 1889/1983

Stacking

> layering, plane, tower

Stage

> entrance, image, scene, stairs

Staggering

> depth, enfilade, facade, incorporation, inside and outside, intermediate space, layering, stairs

Staging

> axis, entrance, experience, image, light, ritual, scene

Stairs

In flights of stairs and staircases, architectural space develops towards high points. Like virtually no other elements, the staircase conveys a feeling for space; it generates space and guides us through it. Through the choice of the dimensions of the stairs and the rise-tread ratio, the rhythm created by the placement of landings and changes of direction, through narrowing and widening, through views and lighting arrangement, through sound and the sensations caused by contact with surfaces, the simple act of ascending (> ascent) a staircase becomes an intense experience, one that becomes noticeably even when perceived in an incidental fashion. This act merits our attentiveness all the more so when it is not performed heedlessly, but instead enacted like a performance in which the climber is the protagonist. In this way, architecture creates scenic situations that may change as a staircase moves from one level to the next.

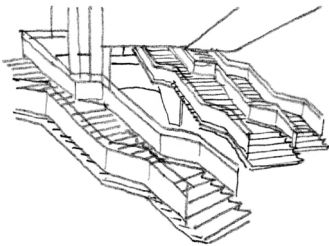

A staircase functions as a threshold or joint within a spatial structure (1), calls for a specific type of movement (2), constitutes an autonomous space or stairwell (3),

or stairs shape town and landscape through terraces and exterior flights of steps (4).

1. The individual step already distinguishes between above and below. When steps participate in a spatial situation, communication through ascent and descent can be supported as a means of an extended body language. At times, it suffices to climb a single step in order to dominate a situation. As a basic element, the step is a kind of separator which also performs the function of a > threshold. The shallow step of the kerbstone, for example, suffices as an explicit delimitation between street and sidewalk, and a single-stepped base is already an effective means of elevating a facade above the ground upon which it stands.

Steps can also be used in order to accentuate the importance and the separating effect of thresholds. Moreover, flights of stairs themselves are threshold spaces, which prepare for reorientation or evoke specific expectations. By closing the gaps between storeys, moreover, they resemble bridges, which overcome the disjunction between separated areas. On a staircase, one is neither here nor there.

A vertiginous feeling may arise on staircases without clear lateral containment, whereas a shaft set between narrow walls seems to lead downward into an abyss. In the context of the building, the staircase forms a vertical > joint that, as a form of > access, assumes a preeminent role as a key location within the > spatial structure. In many instances, it is the staircase that provides an understanding of a building's spatial > order or of its architectural > concept. The stairwell, expanded to become an airspace, creates a vertical connection that makes it possible to grasp the spatial structure in elevation.

2. Through the alternating positioning of horizontal and vertical elements in this form of risers and treads, the staircase's figure of ascent embodies the basic constitution of our physiological existence. The vertical corresponds to standing and walking as conditions of our upright posture, while the

horizontal plane offers the required stability of the ground (> floor). Together, they form the right angle that is preferred as a norm. In contrast to the slanting plane or ramp as a gradual transition between levels, the stairs form discrete, connected, intermediate levels that decompose a vertical gap into practicable steps. At the same time, as a composite of the positioning and stratification, they represent basic elements of > tectonics. Proportion and rhythm of the form through which a staircase is ascended are essential for our gait; with some persistence, we favour consistency of movement in ascending and descending.

An important precondition for a practicable staircase is a consistent relationship between the height and depth of the steps (riser and tread), and with a ramp, a uniform incline. Perpetual variation would hinder a rhythmically uniform pace; losing our step, we would falter and stumble. Through prior experiences with staircases, we have generally internalized a schema of ascent that allows us to arrive at the gait that allows us to best negotiate a given set of stairs. More than other architectural elements, a staircase prescribes the movement that takes place upon it, guiding it: at the start, it receives us, confronting us with a series of distorted or spiraling steps, subdivides stages of ascent through landings, steering us by means of curving or twisting flights, reversing our trajectory of movement through changes of direction, and not least of all, shaping the appropriate form of use through the gradient of ascent and the formation of steps and railing/banister. Idiosyncratic arrangement of stairs, i.e. those found in Baroque staircases, induce a characteristic > figure of movement during ascent.

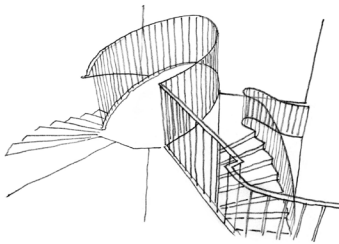

3. Stairs are not only access elements for the building as a whole, but also generally demand their own staircases. These either consist of stairwells or > space containing walls, or they occupy major portions of buildings as representative staircases, and seem to want to ‘appropriate everything, to conquer the entire interior of the building,’ as Michel Tournier

(1979) has said; they evoke ‘thoughts of living on the steps, of sleeping on the landings’.

Generally speaking, a staircase is a distributor through which occupants or users gain access to rooms, but it is also a place of encounter, of exchange, where we perceive visible or audible traces of everyday life. The architecture fosters such communicative functions when it goes beyond the pure channelling of movement in order to offer opportunities for temporary sojourn, whether as economical extensions of space or as painstakingly designed spaces of arrival and encounter. For purposes of > entrance and self-display, details are not unimportant: it matters whether one emerges to view from above with one’s legs appearing first, or whether an adroitly positioned stair head allows one’s entire figure appear from the side.

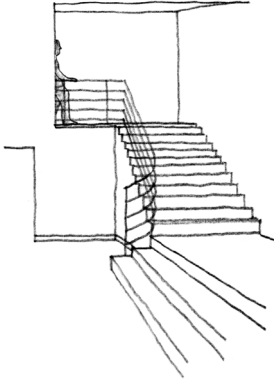

The architecture of representative staircases in palaces, courthouses and opera houses do justice to the enjoyment that can be offered by perceiving one’s own dramatized movements in relation to other moving bodies. Now, the staircase becomes a stage. In the Baroque in particular, its scenic potential was exploited in especially splendid and refined ways, with spacious staircases serving to stage magnificent ceremonies of reception and escort. In public buildings during the nineteenth century, including Charles Garnier’s Paris Opera, the staircase becomes a scenic metaphor for society as a whole whose members comment upon one another’s appearance while ascending and descending, just as in social life, and even comment on the way in which they themselves are being observed.

Basically, however, any domestic staircase, providing it opens out upon a room of sufficient dimensions, can be used as a stage for a modest entrance. In this instance, the staircase can just as well serve as a place to sit, in which case it offers the spectator an unobstructed view. On a larger scale, this form was widely diffused in the antique amphitheatre, where the area below the steps (orchestra) serves as a stage.

4. This possibility is otherwise offered by outdoor staircases, onto which one exits a building and from which one views activities from above. From here, one can approach arrivals as they ascend, performing a greeting as a reception. Outdoor staircases, steps and terraces tie the building together with the topography, and interlace the staggering of levels via gradual transitions from inside to outside. Where staircases in public spaces render high gradients negotiable, they carve up slopes into steps and platforms, thereby converting the uneven topography of an urban district, or even an entire town, into a stepped landscape, examples being various locales along the Mediterranean coastline. Movement through the city is thereby endowed with a certain dramatism, emphasizing a given district in relation to level ones. Spacious staircases, particularly those dating from the Baroque era, offer opportunities for making almost theatrical appearances in urban space, an example being the Spanish Steps in Rome, with their various landings, which serve as stages. The arrangements of relatively shallow steps and stairs found along rivers or seacoasts allow visitors to approach the water cautiously and to control the degree of immersion in a stepwise fashion, an example being the ghats found in India.

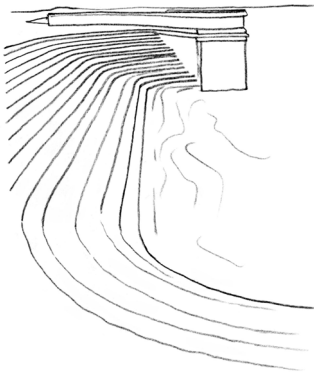

Water cascades and stepped turf are the only types of steps that appear in landscape gardens, since the transition between gradients is meant to appear maximally natural here. In the formal (French) garden, on the other hand, the rise and fall of uneven terrain is reshaped by means of a strictly ordered composition made up of terraces, platforms, terraced gradients, shallow steps, and ramps. The garden layout acquires a special character as a kind of ‘hanging garden’ in particular from a sequence of multiform gradations between levels.

Literature: Bachelard 1964/1994; Giersch 1983; Meisenheimer 1983

Standing	> body (human), form character, ground, postures, symmetry
Statics	> form character, movement, structure, tectonics
Step	> ascent, intermediate space, plane, Raumplan, stairs
Street	> axis, movement, route, square and street, urban design

Structure

In describing structure, we allow the gaze to glide between objects, so to speak. It is a question now not of the elements and forms in and of themselves, not of the rooms, structural elements or buildings, but of the relationships between them. The whole is composed of independent parts, between which recognizable relationships exist. A typical form of relatedness in architecture is the structural texture. While the > spatial structure characterizes the assembly of the rooms within a building or of public squares within a city, the construction is responsible for the assembly of the component parts. In order to clarify the assembly of parts in design terms, those places where they converge receives emphasis as joints, hinges, or connecting links or joining pieces, accompanied at times by changes of material. Such measures clarify the structural assembly of the architecture visually on various levels, and render it readable in a differentiated way.

On a more abstract level, structure characterizes not transitions between elements, but their relationship and their > composition. Here, it is a question not of concrete form, but of a system of relationships that underlies their assembly, which is not immediately visible. In this sense, the structure is an abstraction. A structural approach, then, also means an awareness of the exchangeability of individual positions and interlinkages within a structural configuration. Articulated in structure are characteristics of an architectonic layout that are only indirectly perceptible in a building's appearance and workmanship. One and the same structure may correspond to diverse concrete design formulations; in this sense, structure is related to > type. Because it closes itself off to direct experience behind the concrete appearance of architecture, a

structure must be uncovered before it can be read and comprehended.

Even a load-bearing structure is not always perceptible on the surface. To be sure, the construction is accessible to experience to the extent that the tectonics of the assembly of the parts is rendered visually evident. A classic example is the transitions between temple columns and the architrave and substructure, which are accented by the presence of capitals and bases rather than converging without interruption. But even when the facts of structural assembly along with joint areas are given visual emphasis, the individual structural relationships remain a regulated system that is not always available to perception in the surface appearance of a building. In our experience, the simple fact that traditionally, most buildings are rectangular does not bring the realization that this form is based on the structural properties of a specific roof construction, namely the circumstance that as bar-shaped constructive elements, beams, stringers and rafters are generally straight, and are arranged in the simplest way so that one lies perpendicular to the other. The 'structural potency' (Wilkins 2000), however, of this theoretically transferable structure makes it possible to build a variety of types on its basis.

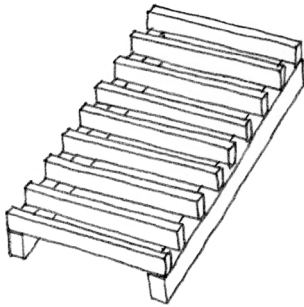

Confronted with a spatial structure, we initially perceive only individual spatial forms made up of walls and openings, while the structure itself remains substantially concealed. Analytical effort is required before it can be identified as the system of relationships. Even the layout is not directly perceptible as structure; we experience individual rooms, not the relationships. More immediately evident, in contrast, are the spatial relationships that connect parts of the building, which emerges to view through the access system – the 'infrastructure' of corridors, flights of stairs, and joints – which is readable almost like a diagram of connecting lines and nodes. Very different buildings, in fact, share the same spatial structure.

To be sure, the structure of a town or housing estate shapes life in a given urban district in decisive ways. Nonethe-



less, we do not perceive the structure as such with immediacy within the concrete situation formed by urban spaces, streets and plazas. As a rule, it becomes manifest only on the plan, where structural parallels to other quarters or towns become recognizable. Plans and maps subject reality to processes of abstraction, isolating selected structural features and presenting an interpretive matrix. We can interpret these as the key to the character of an urban district, as the way in which historic and social structures are registered in systems of access, and types of development, and in the change from a quarter to its surroundings. Once recognized, the structure can then be identified in reality and on location.

Since the emergence of the intellectual tendency known as Structuralism, it became recognized that architectural structures often represent wider structures of action, social relations or thought, and can be interpreted as their expression. It becomes clear that buildings and towns also derive their meaning not simply from the circumstance that they are good to live in, but they are also – to invoke a celebrated sentence by Claude Lévi-Strauss – ‘good to think with’.

Sublimity

The experience of sublimity is inherently contradictory. It involves the sensation of being overwhelmed by something that cannot be comprehended, and at the same time, of mastering it through aesthetic and intellectual processing. That which shocks or disturbs makes a more powerful impact than that which persuades or pleases. Differently than the > meaning that is expressed by a building, or the > beauty we experience through disinterested contemplation, the sublime triggers a state of inner movement. We are impressed by the size of a sublime building, and overwhelming space not simply through seeing it; we are absorbed into it. When we are overcome by the immeasurable emptiness of gigantic spaces or by an extreme overabundance of > light, we find ourselves in a boundary situation.

In aesthetics, we encounter the notion of the special impact of the awesome or the immeasurable, which evokes sensations of sublimity, originally through our experience of nature, e.g. viewing a mountain range. Large buildings also seem immeasurable when their dimensions can no longer be grasped by the senses. Since the idea of the immeasurable is nonetheless accessible to thought, such structures are a stimulus to mental activity. Because the sublime surpasses sensory perceptibility, it is strictly speaking unrepresentable, and is hence all the more a special challenge for art. Precisely when our sensory experience encounters limits, we are stimulated and even drawn towards the often disturbing experience of the insufficiency of our sensory capacities. The everyday understanding of the sublime, however, tends to swing between empty pathos and a flattened-out reference to the noble, dignified or solemn. In fact, the sublime slides quickly from the highly serious into the utterly ludicrous. We encounter the sublime in architecture primarily in the religious sphere, where majestic dignity is intended to generate impressions of the supernatural, which penetrates our awareness in relation to our boundedness by the profane realm. Transferred into the political world, such overpowering effects risk converting architecture into an instrument of totalitarian terror; on the other hand, they also play a role in generating the moving or thought-provoking effects of memorials and historic sites.

Extreme > size is frequently mentioned among the architectural resources responsible for generating sensations of sublimity. Such effects come about primarily through impressions of limitlessness that emerge through the impossibility of compassing an architectural ensemble. Alongside size, the use of arrays of identical elements, for example closely positioned and seemingly limitless rows of columns, also play a role, as proposed by Étienne-Louis Boullée. Effective here is not simply the visual effect as such, but even more so the sensation of being led into an unattainable distance through the > sequence of elements. The individual's confrontation with

a seeming nothingness, with rooms with a vast extent or of the most severe barrenness, as well as the experience of being submerged in total silence, extreme darkness or blinding light, also invoke the experience of the sublime. Alongside grandiose gestures such as the steep, precipitously rising spaces of Gothic cathedrals and the dynamic whirlpools of the Baroque, subtle atmospheric suggestions of the sublime can be evoked through light and sound.

But we ought not feel exposed without protection to the oppressiveness and irritating quality of such boundary experiences. Before they can produce a shudder of fascination, aesthetic distance is required. Even when we feel utterly lost in the pull of boundless extent and emptiness, or the gloom of a darkened room, we may nonetheless be certain of remaining unharmed. Even when the sublime casts us down through its vastness, we should nonetheless – and despite the sensation of smallness we must endure – participate in the sensation of grandeur that characterizes the situation as a whole.

Literature: Boullée 1987

Superimposition

> incorporation, inside and outside, intermediate space, space-body continuum, transparency

Support

> arcade, column, density (spatial), hall, heaviness and lightness, structure

Surface

Surfaces serve a dual task in architecture. The surfaces of walls and space-forming elements are the boundary surfaces of their bodily masses, and at the same time the boundary surfaces of the space that they form. They are the places where > body/mass and space touch one another, and serve both as delimitations. This competition between contours is staged on the surfaces. There, body and space become perceptible through the senses. We probe surfaces with our eyes, follow them in their reliefs, their projections and recessions. The eye

wanders, for example, across the convex exterior of an architectural volume, moves around it, but also glides over to the surfaces of neighbouring buildings that form the contours of a public square, before continuing onward to the concave inner side of the delimitation of the square. Within a > space-body continuum, surfaces establish connections between > concavity and convexity as well as between > inside and outside. Similarly, the surface of the concave inner side of a niche leads across to the adjacent wall via the convex exterior of a framing pillar. On all scales, body and space pass over into one another through the continuous plastic modelling of surfaces or by being folded (> folding) into one another.

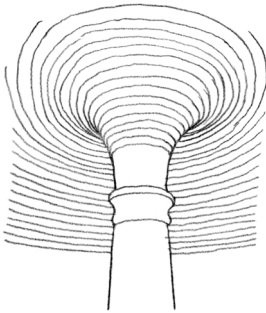

But surfaces play a role in architecture not just as the boundary surfaces of bodies and spaces; they also furnish perception directly with stimuli that correspond to the senses of touch, sight and smell. Surfaces determine the impression made by colour and material, while influencing optical and acoustical reflection behaviour. The sensuous effects of architecture rest to a large extent on the treatment of its surfaces. The groping gaze receives haptic impressions that substitute for those gained through touch; via > synaesthesia, the other senses come into play as well.

Recognizable on surfaces in particular are the various characters of the > materiality; the effects of materials on spatiality are developed there. Special effects that are generated through the treatment of the surfaces themselves are also visible here. Strong effects of translucency and light fusion, conditioned by the respective depth of penetration of the > light, cause surfaces to appear soft; without diffusion, conversely, they appear hard. Various types of reflection generate a glossy sheen, a matte gleam, and other optical transformations of the light. Through shimmering or iridescent surfaces, an impression of vibration can be generated that encompasses the space as a whole. Through the depth of the light that penetrates the surface, coloured glazes and transparent layers of plaster such as *stucco lustrato* endow a room with additional

> depth. Coarse plastering allows shadows to be cast across the surface in raking light, making a velvety impression and darkening colour. While opaque layers of paint obscure transitions between materials and seams between constructive elements, the original surface structures betray the underlying material, suggesting its greater depth and inner structure. Surface graining, for example, generates an impression of continuous > porosity. In 'showing through', the surface becomes a 'flattened depth' or a 'shallow space'. When a virtual > interspace between surface and spatial depth is suggested by a special wall construction, the result may be irritating forms of visual stimulus.

Many different expressive effects emanate from surfaces; they are responsible, for example, for the impression that a > facade makes on a beholder, for example when rustication, a polished natural stone cladding, or a coat of paint provide very different signals concerning a building's character. Surfaces play a special role as well when it comes to generating > atmospheres. Smooth surfaces reflect sound and light in a harsh manner or mirror their surroundings; they allow rain to roll off, and make it easy to lose one's footing. Their atmospheric character forms a counterpart to textures formed by soft mesh or woven materials that offer strong acoustic absorptive capacities and greater adhesion. Here, it is often difficult to distinguish between undeniable effects and superficial clichés. The smoothness of cool surfaces is often associated with the sterility of the operating theatre, and correspondingly, wall-to-wall carpeting with cosiness. Yet it is only a differentiated perception, in particular through the direct experience of touch, that reveals a surface's true effect. The > invitation character of surfaces is evident in particular on floorings (> ground). Rugged, slippery, stony or soft floorings call for differentiated approaches to walking. Through > coverings designed to conform to an occupant's tastes, the surfaces of interior rooms often reflect an individual's personality. Personal accessories are for the most part distributed across

surfaces. We find here the traces of > use, as material deposits, wear and abrasion, or as smooth or polished areas resulting from continuous physical contact.

Surface area

> ceiling, plane, facade, field, ground, surface, wall

Symbol

As a rule, symbolic architecture refers to a > meaning that lies outside itself. A specific architectural symbolism results when the concrete spatial experience of the building also corresponds to its symbolic significance, or agrees with it to a certain degree, thereby embodying an especially active symbolic force.

Although the concept of the symbol is defined in various ways, the above conditions for symbolic power must be delimited in particular in relationship to the concept of the convention-dependent sign, with its purely referential function. When two lines cross to form the letter X, the result is a > sign that is decipherable only in relation to the code of a particular form of writing; its significance does not emerge from its form. Even if the cruciform ground plan of the building symbolizes the cross of Christ, symbolic value is confined to a relatively narrow sphere of validity – that of the Christian image world. Here, the sensory experience of space one has in the building itself does not play a particularly important role in either reading architectural form or assigning significance to it.

Inherent in the crossing of two spatial trajectories in a cruciform plan, on the other hand, is a symbolic power of more far-reaching validity when real movement along a pair of crossing axes refers to the inherent meaning that makes itself perceptible in the total situation: the moment of decision at a crossroads, the convergence of contrasting directions, expansion into the fourth cardinal direction. One example is the cruciform ground plan of a basilica, by virtue of its real

movement structure. While the path of the liturgical procession leads axially towards the main altar on the east side, the layout of the transept, with its arms pointing north and south, offers the congregation lateral points of entry. The relationship between priest and congregation and the analogy of the head and limbs are endowed with concrete spatial expression through the spatial experience of these opposed directions. Like intersecting trajectories, other incisive, gestural formal traits (standing-bowing, closedness-openness, retreat-turning towards), as well as metaphors and > images with generalizable character, also bear this potential to the degree that the significance of the symbolic form is not only sign-like, but also finds expression directly in > form character or > atmosphere. Gothic bundled pillars with fan vaults not only refer to groves of trees with their ramifying branches, but also offer – at the level of form – the corresponding protective or screening experience. Balthasar Neumann's Bruchsal Staircase symbolizes the contrast between heaven and hell, and allows us to ascend quite literally out of the darkness and into the light.

The specifically architectural character of this form of communication rests not solely on visual evidence, but also on complex experiential processes. For example, the act of > ascent (and not simply of the stairs themselves) bears the symbolic meaning of overcoming one's own weight; it is also an act of liberation, the attainment of unhindered views, and may also evoke further experiences of a general nature.

If, finally, architecture is to represent the entire universe as a symbol system, then it cannot be based on image or text like other sign systems, such as the *biblia pauperum* on the figural programmes of medieval cathedrals; instead, such representations must arise visibly from specifically architectural means. Based on the concrete experience of spatiality, the entirety of the world then becomes graspable through the specifically spatial structure of a work of architecture: through the experience of the difference between interior and exterior, it becomes possible to conceptualize the unity of divi-

sion and connection; of body/mass and space through their figure-ground relationship; of load and support through the overcoming of the forces of gravity; and of space and time through the structuring of spatial movement.

Symmetry

Symmetrical order and its transcendence coincide in human form itself. To be sure, bodily organs and limbs are arranged symmetrically, yet their functions are not strictly symmetrical – architecture is perceived in analogous ways. Certainly, a vertical mirror axis placement plays an important role in perception, but when it dominates a > composition, it can become stultifying.

In the present context, the concept of symmetry rests on its current and customary definition as axial symmetry, for which the identity of forms through mirroring or the rotation of repeated elements is essential, as it is for point and rotational symmetry. A more differentiated conception of symmetry (i.e. meaning literally ‘to measure together’), and one no longer current today, corresponds to that which antiquity referred to as *eurythm*, referring not to the identity of elements, but to a balanced relationship between corresponding parts that follows a certain rhythm and is displayed in a building’s > proportions.

In contrast, axial symmetry corresponds to a feature of our bodily organization. Essentially, we carry vertical axial symmetry within our own frames. Converging in it is the upright posture, which opposes the forces of gravity, and the axial positioning of bifocal vision; horizontal symmetrical axes do not have the same significance for us. The virtual subdivision of the field of vision into symmetrical halves that lie to the right and left of the main axis of vision corresponds to the symmetrical division in breadth of the space that lies before us.

That the vertical axis is related to the upright stance of our bodies must be the reason why we perceive buildings with

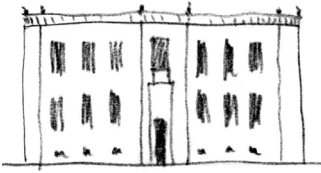

an incisive symmetrical axis as standing – even when they are wider than they are tall, and actually manifest ‘recumbent’ proportions. The tendency to read symmetry from the axis corresponds to the notion of an extension into breadth of symmetrical spaces from the middle outward towards both sides. The gesture of buildings with wings, then, is receptive, but also capturing and dominating. The impact of a passage into depth is heightened by symmetry, for example by double rows of pillars or an avenue, the symmetrical accompanying elements recapitulate and underscore the central axis, thereby concentrating the pull into depth perspectively. Through symmetry, the beholder is assigned both a standpoint and an > axis of approach. Movement along an axis is at times deliberately blocked by ancillary structures, creating tension between a hindered approach and the pure idea of an axial trajectory of movement, an example being the layouts of Baroque parks.

Point-symmetrical layouts too generate pressure to adhere to symmetry, and guide the beholder towards a centre in relation to which he or she is, however, unable to bring bodily disposition into conformity, prompting an > oscillation between centre and periphery. As a wholly centred form featuring multiple symmetry, point symmetry generally supports ceremonial functions, or, in the perfect form of the sphere, is understood as a cosmic symbol, an example being Étienne-Louis Boullée’s Cenotaph for Newton. It therefore tends to be directionless and the floating suspension of all opposition.

Essentially, symmetry has a highly ordering effect. ‘Symmetry pleases the spirit by virtue of the readiness with which the object is immediately graspable in its totality.’ (Montesquieu, after Kambartel 1972, 65) Mirror symmetry does not only mean the juxtaposition of two identical mirrored sides, but also generates a tripartite hierarchical order consisting of the left side, central axis, and right side. The equivalence of the sides hinders an impulse towards movement that is oriented towards one side. ‘With symmetry, tranquil-

lity arrives' (Frey 1976), which is why symmetry is often an expression of immobility, solemnity, timeless meaning, and power (> monument). A high symbolic value is attached to the experience of being led towards a centre by a symmetrical order.

The other side of the coin is the trivialization of architectural design through mirror symmetry. Of course, a perfect square can be interpreted as symmetrical, but the cumulative repetition of mirrored forms soon makes a simplistic impression. It can function, then, as a readily available recipe for making even a botched facade appear more or less presentable, but often deprives it of all tension. But symmetry need not necessarily be immediately evident; it can function as a kind of concealed adversary of asymmetry. 'Symmetry becomes better the more difficult it is to locate its axis.' (Tessenow 1916/1998, 29) The reward is well worth the perceptual effort involved. The vital equilibrium of the neoplastic architecture created by the De Stijl architects can be regarded as a modern form of 'quasi-symmetry' that has been called into question, and then restored in its subtle fragility.

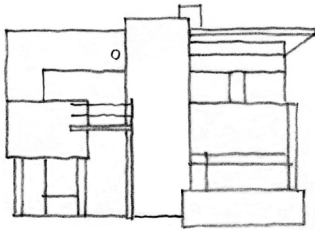

Literature: Frey 1976; Naredi-Rainer 1995

Synaesthesia

Designations such as pink, smooth, clattering, dull or soft refer not just to sensory qualities, but also to entire complexes of sensations. The fact that > colours and tactile impressions, along with > sounds, possess not only the respective sensory quality, but also a more far-reaching expressive quality, and in particular an atmospheric effect, is due to synaesthetic or intermodal qualities, that is to say, the interaction of sensations from various sensory realms resulting in a combined sensory experience.

Pink walls, for example, are experienced not only as having a colour of a specific frequency, but often also of conveying the feeling of a lukewarm temperature, a soft tactile sensation; they may even possess something of a sweet odour

or taste. The smoothness of floorings or the surfaces of furniture possesses not just a tactile quality, but also a dynamic aspect, so that one perhaps senses a certain coolness, or has the impression of hearing a hard sound. The first instance produces a characteristically pink, lukewarm, soft-sweet atmosphere that corresponds to particular intended uses, such as a boudoir or a pastry shop. In the other instance, the smooth, dynamic or hard mixture generates an atmosphere of practicality and austerity. Opening itself up – in one case with a point of departure in a colour sensation, and in the other with a haptic impression – are complexes of further sensations, all of them tending in the same direction. Common to the elements of each complex is a shared mode of experience, which shapes the entire > atmosphere of the respective situation, without any one individual sensory impression being controlling or decisive: each may stand in for the others. In one case, a clattering sound may stand for extreme coldness and a harsh bluish light; in another, a toneless rumbling for an airless environment and dull brownish coloration; and finally, a gentle rustling of a curtain for the smooth relief structure of a surface and for weak shimmering light.

To be sure, the individual sensory impressions can be linked to one another by association as well, for example red-orange with pronounced > warmth, suggesting fire. But their synergy rests primarily on a shared experiential quality that shapes the atmospheric character of the situation, and which rests on bodily experience of congruent sensations. But the way in which atmosphere is actually experienced is only evident in concrete instances, and cannot be predicted by means of stereotypical correspondences between material qualities and temperature sensations: wood is not always experienced as warm, nor is steel invariably associated with cold. Every constellation is different; experiences often depend upon details, and change according to context. The conventional idea normally linked to the colour pink on the one hand and the materiality of granite on the other tend to misfire when are

encountered together in an Egyptian tomb chamber.
Literature: Böhme 2001

Table	> furnishing, gathering, plan
Tactile	> haptic qualities, materiality, sensory perception, surface
Technics	> architecture, detail, materiality, structure, tectonics

Tectonics

Karl Friedrich Schinkel (1979) sums up the role of tectonics when he says that architecture is ‘construction elevated through sentiment’. The constructive aspect, then, ought not to be restricted to physical requirements, but expressed perceptibly through form as well.

The constructive functions of columns, beams or window frames are endowed with vivid expression only when they are rendered graspable by the senses. It is far from easy, since the distribution of forces or the demands made on materials, for example, remain hidden from sight. Nonetheless, analogies with comparable processes taking place within our own bodies provide us with some notion of them (> empathy). ‘We have carried loads, and learned what pressure and counter-pressure are, (...) Therefore we know how to value the proud joy of a column’ (Wölfflin 1886/1999). Through analogies with the human body, tectonics corresponds to our existential state of mind, as when the upright position of vertical elements expresses independence in relation to resistance offered by the downward pressure of gravity. Only through the contrast with the verticality of our upright, standing bodies and the horizontality of reclining on the earth does the dynamism of free forms acquire their dramatic potential.

Independently of analogies with the body, the tectonic function of the > column is also noticeable when it is formed so that the pressure from above is made visible through swelling (entasis), which at the same time expresses the force of resistance. Tectonic qualities are visualized directly through

an element's > form character, allowing the way in which the parts of architectural structure carry loads, embody weight, or rest are made vividly manifest. The underlying base of reference for tectonics is the earth itself, upon which the building either rests stably, or from which it is deliberately detached. The way in which it touches the ground (> base), then, must be distinguished from its upper terminus. Between earth and sky, architectural > structure is realized in the most diverse ways. Virtually always, however, it is made up of various components. This is either the modelled or carved and layered mass upon which, according to Gottfried Semper, tectonics in the narrower sense is based, i.e. the framework of bar-shaped parts designed to stiffen the actual spatial shell. Or, as in contemporary building technology, the assembly of a multiplicity of components, in many instances no longer individually identifiable. The tectonics of the building should visualize the functions that are fulfilled by the individual elements of the structure; it should display the way in which the building is articulated through its parts (> detail).

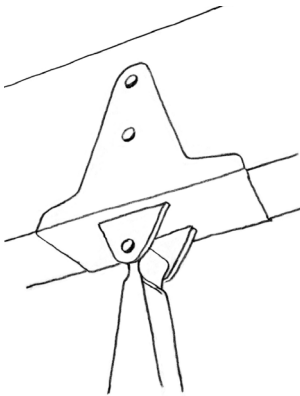
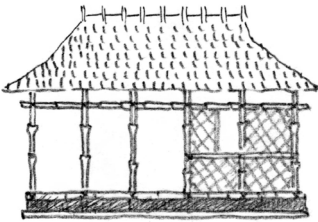

For our daily interaction with architecture, in particular when it is a question of the concrete operation of its parts – doors, windows, staircases, handrails – familiarity with objects is decisive. For the architecture to be comprehensible, the essential question is whether the parts of the building are manifested as a nontransparent ‘apparatus’, or instead as the comprehensible ‘objects’ (Posener 1981) of everyday activity, whether their functions are accessible to the senses, or their forms conceal function behind homogenizing design. Our familiarity with architecture is facilitated when we are offered expression of permanence and substances that is attained through a tectonic conception of architecture, rather than an ephemeral appearance.

In antiquity, τέκτων (Greek: *tekton*) was initially the name for a carpenter; later, it became a general expression for a building master, one already bound up with poetic and aesthetic claims. Surfacing very early was the question of the dif-

ference between authentic and false, one that was concretized, finally, in the distinction between real construction and cladding. When, in a facade, Mies van der Rohe allowed a non-load-bearing steel profile to represent the load-bearing support that he concealed behind it, he created a visible representation of the supporting structure, albeit one that was inconsistent with the actual distribution of forces. In tectonics, then, the > covering of the construction, and with it, the ornamentation (> ornament), often assume the task of providing a representation of the construction through sentiment.

Literature: Frampton 1993; Kollhoff 1993; Posener 1981; Semper (1860–1863/2004); Wölfflin 1886/1999

Temperature	> comfortableness, materiality, sensory perception, warmth and cold
Tension	> atmosphere, body (architectural), confrontation, depth, expansiveness and constriction, dramaturgy, extension, field, force field, movement
Terrace	> base, garden, intermediate space, plane, roof, stairs
Territory	As soon as we are present in the world, we begin not just to exist in space, but also to occupy space. We lay claim to space, and in order to secure our sphere of influence, we must mark it out, for example by ‘reserving’ a chair by means of an item of clothing, defending against incursion by others. This designation of territory (Latin: <i>terra</i> , earth) in order to ensure our claims to a protected sphere of influence is a basic human need, and extends from the individual to the family, the community, and finally all the way to the territorial state. Originally, territorial claims were driven by the need for access to resources and protection from a variety of environmental influences, and given the existence of competing claims to space, have always been a field of pronounced potential conflict.

In relation to its basic function of > screening of an > interior in relation to the outside, architecture is continually concerned with endowing the boundaries of various territories – whether the room, the residence, the building, or walled-in town – with visible and physical expression. If it is true that the essence of an entity begins with its boundaries, is determined by them, as Martin Heidegger (1953/1993) said, then territory is the basic form of spatial determination, and the architectural expression of demarcating boundaries is a predestined act of determining its essence.

But architecture does more than to draw and clarify spatial boundaries through enclosures consisting of walls, fences, hedges and trenches; through buildings, it also occupies ground that was formerly free, whether a building site, urban zone, or landscape. In the process, the premises as a whole are altered in the > context of the area. In question is more than the presence of a house; routes have been interrupted, views blocked, the surroundings submerged in shadow. Access routes, odours and noises have an impact on the entire vicinity. Existing as a counterpart to the territory is a no man's land, the fallow terrain, the terrain vague, to which no one has made territorial claims. As an 'indeterminate terrain', it offers openness in relation to use and, leeway for appropriation according to individual purpose.

The private parcel of land, the field, the quarter, the communal district, and the homeland: each consists of a piece of land that, even prior to any act of building, has been laid claim to and affectively occupied as personal or social space. Even in the absence of any visible demarcation of boundaries, it constitutes an interior where one is with oneself, and the other is ostensibly foreign. The delimited territory is not only experienced as a sphere of influence, but also as the boundaries of the self, one that is marked, according to Karlfried von Dürckheim, by the house or apartment door, for example. 'We experience the gate as a personal boundary. We open it in the fullest sense only to those who belong to us; if another

presumes the freedom to enter, we experience this at the unauthorized transgression of a personal boundary, and we experience every infringement of a boundary as an injury done to ourselves.' (2005, 93)

Physically perceptible to differing degrees, the living territory extends even further, to the limits of the property, to the hedges, to a fence, or to the edge of the forest. In gazing out of a window, the surroundings are incorporated into the realm of one's own residence, which can be accompanied by the inconvenience of disturbing elements and the annoyance of undesirable encroachments. It is here that conflict begins: the individual strives to control the space of the city as his or her own, but as a collective space, it is uncontrollable. When the vicinity of a residential quarter is regarded as part of one's personal space, or as the space of one's own family, then public facilities may disturb one's private life, even solely by their appearance. A residence for people with disabilities, a kindergarten, an athletics field, or perhaps a neighbour's new carport may be experienced as interfering with the enjoyment of private living space, and may be resisted as a putative intrusion into the private sphere.

In recent years, the potential for conflict has been elevated further, with the increasing valuation of individual life and a pronounced tendency to retreat into the private realm. The importance of personal autonomy leads to a compartmentalization of the individual and his or her more intimate social community in an expanded, social private space. The social private space becomes a defended territory, one that must be screened off from criminality, from strangers, or from every sort of change. This stability is enforced with every available power, entry is controlled, homogeneity striven for. The increasing diffusion worldwide of gated communities within which entire residential districts are converted into controlled private spaces, with all of the required residential facilities, as well as the privatization of a formerly public urban space in malls etc., is only the final consequence of this tendency. But

according to Gert Selle, curtains already serve as ‘an inviolable symbolic boundary between one’s own space inside and the hostile outside,’ in particular as a ‘protection against the evil eye of the world’ (1993, 10). That to which Selle refers as the ‘citadel mentality’ of residents is expressed in an unparalleled fashion by the English expression ‘my home is my castle’.

Texture

> materiality, ornament, service, sensory perception, space-body continuum

Theatre

> architecture, dramaturgy, entrance, image, scene, stairs

Theme, architectural

In contrast to the multiplicity of possible architectural concepts and approaches to design, architecture has at its disposal only a limited number of themes, whose significance goes beyond the individual building task. The formulation of an architectural theme always walks a fine line between general validity and specific architectural content. In contrast to the design idea as the designer’s individual solution to a building task, an architectural theme lays claim to an intellectual content having general validity. The ‘thematization of architecture’, whose indispensability has been emphasized in particular by Oswald Mathias Ungers (1983), links the experience of architectural actuality with the confrontation of a ‘world of ideas’.

Architectural themes, however, must not be confused with themes of a general kind, even if these are of social relevance, such as democracy, sustainability or authenticity. An architectural theme instead deals with a specifically architectural phenomenon, a particular spatial configuration, for example. It is not only propounded conceptually, but also developed architecturally. Ungers, for example, refers to the ‘house within the house’ as an architectural theme, that is to say the multiple cladding of an architectural body, one that is ex-

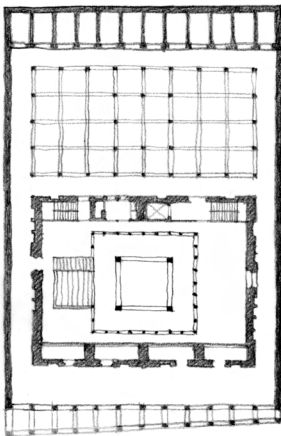

pressed thematically in the architecture through the repetition of the procedure of covering (> incorporation). This provides a point of departure for articulating the generalizable idea of the continuous contentedness of one entity inside of another.

The architectural theme, then, displays a strong affinity with the > type. Types are themes that have already established themselves in praxis, and in the course of architectural history. On the other hand, a theme (Greek: τίθημι, *tithēmi*, to place, to set, to lay) comprises a statement, brings forward an interpretation as a thesis, i.e. by thematizing the house as a wall, as in the case of Ralph Erskine's 'Wall' in Byker. Architectural themes may uncover architectural phenomena in non-architectural forms and convert them into the themes of concrete building tasks through transformation, analogy or metaphor (Ungers 1976). They may be further developed under present-day or future conditions, and their spatial concretization may make possible new types of experience.

This is achieved only to a limited degree by the approach known as 'theming', that is to say, the design of consumer facilities and theme parks with narrative contents. In many instances, narrative 'themes' are simply ported from far-flung places; they are not related to the given framework of real building tasks, but instead simply imposed in a highly artificial manner. As a rule, this form of thematization is designed to distract visitors from concrete, everyday reality, to transport them to a stimulus-saturated fantasy world.

Literature: Ungers 1976, 1983

Theming

> theme (architectural)

Threshold

On a threshold, one is neither inside nor outside. The threshold is simultaneously a place, a boundary, a transition, and an obstacle. By overcoming obstacles, one is aware of transgressing a boundary. In German, the term Schwelle (threshold)

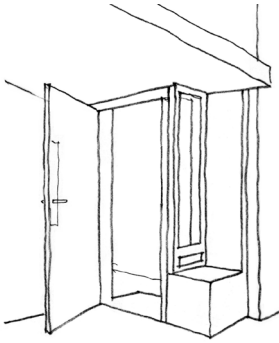

originally referred to the wooden beams that lie on the floor of a half-timbered structure, as well as to door sill as the lower element of a doorframe. As a staggered section of the floor, the threshold forms the lower doorstop. It thereby delimits interior from the exterior, or two rooms from one another; as a raised edge, it demands attention when passing through a doorway to avoid tripping. Together with the doorframe, it forms a flattened space within which one abides briefly when traversing – that is to say, unless one lingers on the threshold. Conceived more broadly, the concept of the ‘threshold’ refers to architectural constellations in which spatial delimitation and the transgression of boundaries condition one another reciprocally. When the threshold involves an expanded spatial volume, or threshold space, then we are dealing with an > intermediate space of the kind that plays a substantial role in architecture in the context of > ingress and exit. The sequential crossing of a threshold that separates the public and private spheres is thematized by the > introduction.

The essential effect of the threshold lies in the interplay of an inhibition and its overcoming. Spaces or conditions that are attained through the forceful overcoming of a threshold are experienced as having heightened value. For visual perception, the elevated edge of a threshold is part of a frame that is completed by a doorframe or by other facade elements, and which functions as an image frame for that which it announces, frames, and hence endows with value. The higher the threshold, the more ambivalent its effects; initially, it excludes, but then offers exclusive access. In extreme cases, the effort of climbing over an extremely high threshold seems almost humiliating, since one lowers one’s head in order to clear the lintel; as a consequence, however, crossing it becomes even more meaningful. Where the impact of the threshold is reduced by means of uniform floor levels and the harmonization of materials, for example in order to reduce the anxiety of those entering, distinctions are abolished. Playing a role in the impact of a threshold as well is the need to

overcome resistance at the wall level. When passing through a > screen consisting of thick, hard, masonry, one has a greater sense of accomplishment than when passing through a cardboard wall.

The sense of inhibition affected by the threshold brings about a stopping and hesitation before crossing that is to some extent compelled, and to some extent born of insecurity. In many instances, one must ring, call or knock and then wait before receiving a reply or being observed secretly or controlled wordlessly. The architectural accoutrements for this situation, including doorbell, spyhole and intercom, are either the expression of invitations to communicate or a means of surveillance and defence. The door niche and porch are sparing frames for the place where one waits and attempts to make contact. The doormat forms the floor for an awkward marking of time, even when the way through has already been opened; a culturally conditioned shyness causes us to hesitate at the entrance to a strange house. This ambivalence does not allow the threshold to one's own home to appear as an inhibition, but as the securing of the > dwelling; inhibition is only for strangers. Upon being crossed, the threshold occasions a change of behaviour, one that is now recognizably dependent upon the character of the rooms, and hence of their architecture. Although thresholds are spoken of everywhere today as 'interfaces', the threshold in architecture not simply an interface of black boxes, but is also conditioned by the characters of the occasionally interpenetrating adjacent spaces. 'A boundary is not that at which something stops but, as the Greeks recognized, a boundary is that from which something begins its presencing.' (Heidegger 1953/2008, 152)

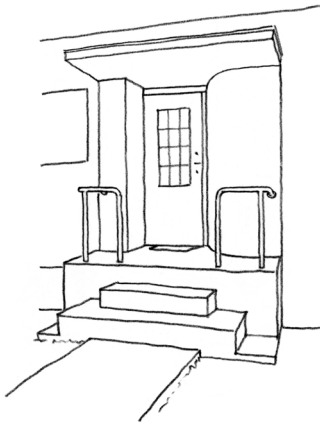

Today, architectural design often tends towards spaces without thresholds, and towards the spatial interlinking of the building with its environment. At the same time, the necessity for controlling admission, for security, selection and surveillance increases steadily, requiring a differentiated regulation of invitation and exclusion, opening and closing. This

leads to a contradiction between the equalization of spatial transitions on the one hand and the growing and ever more differentiated insertion of thresholds on the other. A threshold need not involve walls or doors, but only an air curtain – at least the term should be conceived quite broadly. The overcoming of an obstacle need not be involved; thresholds already exist where the edge of a roof separates a covered zone from one that is set under open sky, where a shadowed space is set off in relation to sun-filled surroundings, or a type of flooring contrasts with another one. Sound islands generated through Muzak are delimited, as are light or door islands.

Beginning with Modernism, architectural boundaries were produced to a diminishing degree by monolithic masonry, by delimiting interior and exterior from one another with single screens whose openings contain simple thresholds. Instead, the wall was decomposed into different layers, into > filters with a variety of functions: against cold, against noise, as sun protection, or privacy shields, or to provide hygiene or security.

The various walls are to some extent staggered in space, and have differing types of openings. Each forms a different threshold, each of which is to some extent given a different placement, and between which threshold spaces are created. There is also a multiplicity of spatial boundary areas or zones of admission that require special types of thresholds, for example supermarket checkouts, counters in libraries or banks, ticket offices, or various types of identity checks. Corresponding to various functions, there are special threshold types whose diversity goes far beyond the traditional architectural types, for example the crowd control barrier, turnstile or airlock. Laurent Stalder has discussed the consequences of the dissemination of threshold situations for use and perception. People who move continually between various thresholds ‘no longer know the difference between inside and outside, but exist in a permanent in-between; no longer experience boundaries, but only possible margins; no longer experience

transition, but only a continual passing through.’ (Stalder 2009, 25)

Literature: Stalder 2009; Waldenfels 1990

Time

Space can only be comprehended through time, and time can only be comprehended through space. Given the consecutive character of their continuous forms, both time and space are experienced only through distinctions between and sequences of points in time or space, between which the respective space, event or situation is stretched. Stretches of road are expressible through time designations, while intervals between events are experienced as spaces of time. Architecture’s constitutive conditions include the interrelationship between static presence and temporal process. Despite its indispensable stability and rootedness in place, a building is never perceived from a purely static position. In spatial perception, we establish distances at every position in space, and we experience their overcoming as moments in time. Emerging from spatial continuity is temporal succession. In architecture, time is conveyed primarily through > movement and > use, through ‘serial vision’ (Cullen 1961/1971), by passing through spatial > sequences and a succession of physical actions. Grasped as > event, architecture is constituted in its spatiotemporal processes through the interaction of many varied influences, separate lines of development, and complex processes.

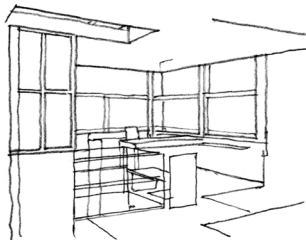
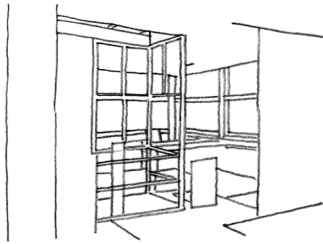

The building itself is not a purely static object, but is instead subject to changing conditions and temporal processes. By operating movable parts such as doors, windows or shutters, parts of the building are altered, opened or closed to a minimal degree, and to a greater extent, by folding or sliding walls, for example in the traditional Japanese house or in Gerrit Rietveld’s Schröder House. Through various constellations of > screening and degrees of > accessibility, the relationship between retreat and common areas is shifted. In residential building in particular, attempts have been made to respond

to changes in family size or living habits through flexible architecture and easily altered plans, for example by means of dividing walls that can be either dismantled or repositioned. More than structural elements, however, it is regularly occurring changes in > furnishings that reflect an occupant's evolving living processes. These often lead to radical reinterpretations of possibilities for habitation and movement.

A building also experiences temporal change through the periodic alternation between day and night-time. As the sun moves, rooms are influenced by the changes in illumination and darkness. Variable relationships between warmth, light and atmosphere generate a range of conditions for activities, to which the building in turn reacts with its elements and features, for example through curtains, sun blinds, or illumination by artificial light. The spatial relationships of exterior architecture in particular are altered by the cycle of the seasons, for example by snow and tree foliage.

A special type of temporality is expressed in architecture in an imaginary fashion. Through its > form character, a building generates an impression of movement, seems to grow taller, to approach us, thereby displaying a dynamic > gesture. This is the basis for the forms of expression upon which Expressionistic architecture or illusions of velocity created by Futurism were based, which are under continual further development today through digital resources. In an imaginary sense, temporality in architecture is also conceptualized through the notion of space-time, which is intended – in ways dependent upon Cubism – to unify space with time through the simultaneous perception of spatial objects from a variety of standpoints. Through transparency and spatial superimposition, such as the continuous glazing of the Bauhaus Building in Dessau, it was attempted to bring together the disparate temporalities of interior and exterior through forms of simultaneity.

Like no other medium, architecture stores time (> memory); not only through the aging that is evident in > patina

and deterioration, or through the wear that leaves traces on footworn or smoothly polished areas, but in particular by the way in which traces of use support familiar situations and endow the surroundings with permanence and stability through enduring aesthetic qualities. At the same time, architecture displays the changes it experiences, registering interventions that are on the one hand experienced as attacks on the familiar, but on the other allow time to be read in space (Karl Schlögel), and which confront us with history in the present. Differing temporal horizons are superimposed, from the short-term effects of current activities and events, which are paramount for perception, to changes of fashion, and all the way to the sedimentation of historical developments in a city's ground plan. Architecture becomes a form of 'collective memory' (Halbwachs 1985) not just as a solidified chronicle of historical events and conditions (> monument), but also by palpably conserving the conceptual basis of architectural ideas and > concepts in the permanent form of architectural structures.

As a rule, however, time brings a multiplicity of conceptual or even tangible reinterpretations. As concrete locations, we can experience and recreate historical processes of growth, destruction, extension as something living through constructive and spatial ruptures, transitions and amalgamations. When we compare our perceptions of works from various epochs, meanwhile, the relationship between permanence and change becomes visible. Registered in the face of continuously changing styles, forms, materials and methods of construction are ever-recurring spatial configurations, which have stood the test of time. Nor should we underestimate the degree to which the passage of time can allow a building to become totally transformed in perception through changes in our visual habits. Habituation too plays a role, so that over time, some buildings become virtually invisible.

Literature: Giedion 1965/1982; Weston 2003; Zucker 1924

Tone	> sound
Topography	> garden, landscape, place, roof, stairs, urban design
Topos	> context, place

Tower It is a kind of impulsion towards the heights that makes the act of climbing a tower so attractive and exhilarating. The effort and the allure of > ascent as disengagement from, and leaving behind the hustle and bustle of the world, our attachment to it, the gradual rising into the heights and the expansion of view and visible space, all are stages in an arduous journey. But they are rewarded by the sensation of freedom, of access to and enjoyment of broad, expansive views. At the same time, a latent awareness of the possibility of falling as we stand securely on a platform offers a special sensation of > sublimity.

A tower is a building with great height in relation to its surface area. Its rooms, set on top of one another, are reached by climbing or by riding an elevator, and are connected to one another for this purpose by some type of vertical axis (> staircase, ramp, ladder, elevator). In contrast to most multistorey buildings, the tower is dominated by verticality, and its rooms are stacked rather than being set alongside one another – in extreme instances, with a single room per storey.

A visit to or residence in a tower, then, is characterized by natural lighting from all sides, and a generally unhindered 360° view of the surrounding, which widens the living space on all sides. Habitation in a tower requires a high degree of organization of everyday life and progress from room to room always entails climbing or descending stairs. Life is divided into > levels; individual activities are invested with varying degrees of priority depending on the elevation at which they are performed.

Only to a limited degree can such experiences be transferred to typical high-rises. Here, the climbing of stairs is generally replaced by travel in an elevator. With considerable

building heights, the rewards of effortful ascent are supplanted by the astonishing sensation of being carried upwards into unexpected heights without effort, while standing immobilized in a moving capsule. The glazed cabin of an elevator that is set in open space, on the other hand, offers the unfamiliar experience of gliding vertically through space.

The hazards and the hubris of the tower construction, from the building blocks assembled by children all the way to the tower of Babylon, as well as the ambition of striving towards a summit and the masculine symbolism of erection: all of these are characteristic of the significance of the tower as a gesture that is designed to impress. The tower is visible from afar as a legible sign of power and aggression, while the multiplication of towers in metropolises necessarily detracts from their symbolic force. As a solitary landmark, the tower provides a point of spatial orientation within a town or landscape, sets an accent, and establishes relationships within a network of locations. But to be successful, a tower must function on two different scales, accommodating distant connections in the heights, and complex local relationships in proximity to its base.

Literature: Meyer 1996

Town planning

> square and street, urban design

Tradition

> memory, monument, time

Translucency

> filter, gaze, light, surface, transparency

Transparency

Literally, *transparency* means ‘permeability to light’. We refer to elements and materials as transparent when we are able to see through them (1). We speak of translucency when light passing through a material produces only a schematic impression of the objects behind it (2). Of special importance for architecture, however, is a different conceptualization of transparency, according to which situations with multiple

possibilities for localization are produced by the ambiguous superimposition and intersection of spatial volumes (3). In general, transparency refers to the covering up, obscuring, or displacement of spatial delimitations.

1. Even literal transparency, which is present in buildings as a rule through glazing, is an ambivalent trait. To begin with, reflections, condensation and soiling often interfere with full transparency; even more importantly, our experiences of glass tend to be highly contradictory. Glass appears immaterial, so that it becomes imperceptible. To the touch, however, it is hard and solid, and it can be dangerous to underestimate the force of its resistance. Even its transparency is a contradictory quality. Jean Baudrillard describes an ‘ambiguity of atmosphere, the fact that it is at once proximity and distance, intimacy and the refusal of intimacy, communication and noncommunication. Whether as packaging, window or partition, glass is the basis of transparency without transition: we see, but cannot touch. (...) A shop window is at once magical and frustrating – the strategy of advertising in epitome.’ (1968/2006, 42) Through multiple reflections, structured or printed glass or other less transparent materials expand the play between display and withdrawal, providing additional stimuli to our powers of imagination. Buildings with large window surfaces or expensive glazing appear wholly transparent. On the one hand, they expose the interior to the point of shamelessness, as in the ostentatious style of the window display. On the other hand, transparency suggests openness. The transparent architecture of Günther Behnisch’s Parliament Building in Bonn, for example, is intended to express the principle of democratic decision-making. Thoroughgoing transparency calls into question the difference between inside and outside, which is the very basis of architecture. Now, architecture surrenders that which actually constituted it in the first place.

2. A spatial envelope that admits light, which it filters or disperses, but not the gaze, is referred to as translucent.

Already the diaphanous (literally: shining through) quality of Gothic architecture (Jantzen 1957) represents such a play with shallow depth and space-containing surfaces within which the light is captured. The stone lattice/grid of the high walls of a nave functions as an architectural relief, one that is set in optical terms either against a dark ground or a collared ground of light. In recently developed facade types, this phenomenon has been cultivated through multilayered membranes of varying light permeability and structuring. Resulting from such superimposition are moiré effects, which evoke impressions of a ‘virtual materiality’ (Gleiter 2002). This results from the emergence of interspaces between individual layers in a way that is reminiscent of the Japanese notion of *ma* (impalpable interstice); these are not however designed for human presence. Through schematically perceptible shapes or the play of shadows, such strategies produce hints and intimations that excite curiosity. The filtering, shading, and structuring of incident light, or the use of wall surfaces that are illuminated from within, generates soft light moods or those charged with special effects.

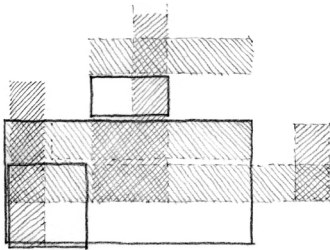

3. In contradistinction to transparency in the literal sense of light permeability, the term *transparency* is also used in the ‘phenomenal’ sense (Rowe/Slutzky 1997) to refer to the superimposition of various spatial figures or systems. Such superimpositions can be experienced in such a way so that here too, figuratively speaking, one spatial figure ‘shows through’ another, which is to say that multiple spatial figures or systems simultaneously constitute the basis for localization, the reference system for the fixation of a position or the framing of a space. Different systems enter into competition for this role, or leave undefined the question of which position or space belongs to which system; now, they may be assignable simultaneously to two or more systems. The perceptibility of such superimpositions presupposes that the architectural manifestation of spatial figures or systems is not unambiguously fixed by spatial delimitations (i.e. walls, supports or edges), but

participates in the spatial containment and the definition of spatial contours of various systems simultaneously. The way in which we perceive such ambiguity exemplifies the types of spatial experiences that cannot be supplanted by computer simulation or film. Such transparency has a special significance in particular for > threshold and > intermediate spaces, where interior and exterior spaces or various internal spatial figures overlap. Often, various historical phases or urban planning orders provide the background from which such superimposition emerges, at times in ways that are correlated with superimposed events and functions.

Literature: Auer 1989; Hoesli 1997; Rowe/Slutzky 1997

Tree

> column, garden

Truthfulness

> covering, readability, tectonics, virtuality

Twilight

> atmosphere, darkness, expansiveness and constriction, light

Type

Characteristic of type is a special relationship between identity and difference or schema and variation. Not unlike > structure, type is an abstraction. Because it assigns a building a specific spatial structure without determining its concrete formation, the type is the accumulation and abstraction of spatial experience in the form of a schema whose concretization permits endless variations.

The concept of type in architecture has a broad spectrum of meanings. The conventional typologies used in building theory are primarily classifications according to types of use, access and plan that are defined by a building's specific functional features, and shared by all buildings of the same type. Other typologies refer to features of construction and design, or to kinds of urban development. Clearly distinct from this is an understanding of type upon which the typification of buildings or building elements is based, and which is oriented towards unification and standardization.

The concept of type plays a productive role in architecture, however, when it is understood in such a way that within it, a certain constructive-spatial structure is coupled formulaically with a specific spatial experience through aesthetic and experiential concentration. Through this coupling, typology goes beyond morphology. In this context, a type is not necessarily represented by the building as a whole, but perhaps through individual characteristic spatial combinations. The > arcade, for example, represents a form of transition between inside and outside, the atrium, a specific relationship of the outside interior, and the > gallery a certain interpenetration of upper and lower. Types that express fundamental human conceptions of space and figures of action in primordial gestures, so to speak (archetypes), possess a special and highly generalizable potential for meaning that can be actualized again and again.

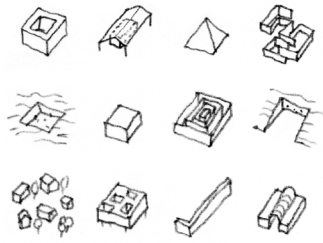

Most types developed historically out of customary usages, craft skills used in building, and regional roots, but their specific original meanings have become overlaid multiply through the course of history by changes of function, and have meanwhile devolved towards a kind of open-ended historical significance. Today, type is identified primarily with a characteristic spatial figure and an associated and typical form of spatial experience that characterizes, for example, the type of the columned hall, the rotunda, or the patio. In this sense, the type must be opposed to the type of utilization; it is not a functional programme. Instead, it characterizes an incisive schema, one that demonstrates a high degree of adaptability and openness precisely through the union of a certain gestalt potential with a characteristic structure of movement, a > capacity that makes it possible to attach continually new realizations and meanings to the framework provided by this distinctive stamp. Aldo Rossi mentions the Palazzo della Ragione as a favourite example, a type one encounters in Padua and other towns in northern Italy. With its open > portico at ground level and the large vaulted hall above, and by affecting a union between the two components, with their con-

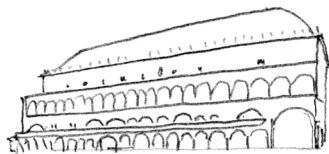

trasting appeals and > gestures, it is an example of a specific interaction of forms, meanings, and modes of spatial experience. In the course of its history, type has endowed through its spatial combination the most diverse functions with a specific meaning: below, market, court hall or restaurant, above, council chamber, stables, museum or concert hall. On the one hand, historic buildings, which represent certain types, serve changing forms of utilization by adopting continually new meanings. On the other, it provides solutions to current building tasks by relying upon established types. The decision in favour of a specific type implies the construal of the building task in the sense of typical spatial praxis associated with it, so the design > concept, hence, involves a 'typological decision' (Rossi 1977). The types provide a repertoire of design schemata of great Prägnanz, and are adaptable to the most diverse building tasks.

Literature: Kemp 2009; Kubnert 1979; Rossi 1977

Typology

> type

Urban design

'It is high time we began thinking about architecture urbanistically, and about urban planning architecturally (...) 'a city like a house, a house like a city' Aldo van Eyck (1960/2003, 38) implemented this recommendation, which goes all the way back to Leon Battista Alberti, in his orphanage in Amsterdam, with its interior plazas and streets. The architecture of the city is not only similar to that of a house, but also sharply distinguished from it: both in the means through which it organizes the relationship between > inside and outside, body/mass and space, and in that between places and routes (1), as well as its total gestalt (2), and in the specific mode of performative experience (3).

1. The analogy between the rooms of the building and those of a city is not just evident in the interior character of

urban spaces having an enclosed feeling. Entire urban districts and localities take on the appearance of familiar interiors when they constitute spatial totalities through unifying architectural features such as building style, scale, number of storeys, facade details, and materials, and through identical street paving and plantings, or through the resultant atmosphere. Also contributing to such effects is the identity-establishing role of a structural centre or central plaza. On the one hand, such features mirror the common history of a locality; manifested in them on the other is their appropriation and utilization by specific social groups. Boundaries and distinctions between urban spaces are registered not just in the form of edges or fringes, i.e. dividing streets, landscaped strips, or the edges of slopes, and to structural shifts within a development, but also through variations in the total atmosphere, with its typical odours and noises from buildings and on the street.

The interdependency between mass and void is more decisive in the shaping of urban space than for the individual house. The degree to which a public building, for example, is set off as an incisive figure in relation to the empty space surrounding it, or is interwoven with the urban texture, depends on the figure/ground relationship between body and space. Clearly, as in the case of Giambattista Nolli's plan for Rome of 1748, some public outdoor spaces are by no means inferior to buildings and (semi)public interiors when it comes to gestalt qualities and > enclosedness, and are hence able to function as spatial containers for public life.

In contradistinction to a spatial figure or body figure that is simply detached from its background, an ambiguous figure/ground relationship or graded transition between building mass and public space allows a > space-body continuum to emerge, together with a diversity of > intermediate spaces and graduated possibilities for stationary activity or movement. In Modernist urban planning, however, the free positioning of architectural volumes largely confines amenity qualities in the

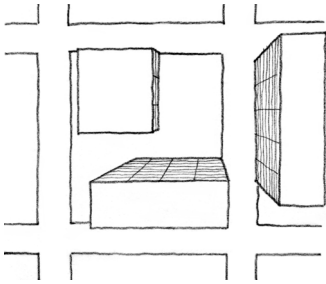

> inside of outside spaces. But with careful composition, it is also possible to form lively interior figures of urban spaces by means of individual buildings, examples being Mies van der Rohe's Federal Center in Chicago or Allison and Peter Smithson's Economist Building in London. Individual buildings are capable of tying together important locales and key places in the city through a network of relationships. While urban areas and residential quarters acquire their identities through the structure of the urban texture and the character of specific quarters, it is the 'primary elements' (Rossi 1966/1982) – particularly in the form of > monuments – that contribute their historic and symbolic significance to a city's identity. They are the orienting and pivotal points of the urban structure, and form the guiding elements and arrival points of > routes. More than the individual building, the city is experienced through > movement: the spatial edges of > squares and streets propel or interrupt movement, guiding it into various directions, or allowing it to come to rest through closed spatial frames. The countless resources available for shaping space in urban design, the contrast of > expansiveness and constriction, > intimation and > confrontation, the application of > thresholds and > joints, of > axes and > sequences – all of these form the toolbox of a > dramaturgy of the urbanistic steering and guiding of routes.

2. To grasp the city as 'architecture' in the sense of a coherent structure presupposes that it is perceived not as an accumulation of buildings and streets, but at least to some extent as a deliberately designed whole. This can proceed through a regular geometry or figure, as found in ideal, planned cities such as Palmanova, Karlsruhe, Brasilia, or more recently Chinese cities such as Lingang. In place of strict geometry or incisive figures, the well-planned gestalt of a city may be recognizable in freer formal structures such as the network or an organic pattern. A basis for the unmistakable gestalt of a city is its site within the > landscape and the impact of the surroundings on the character of urban space. Cities are dis-

tinguished by an unmistakable appearance when they thematize the potential of the landscape in the cityscape, exploiting it scenically and utilizing it in detail for the structural and spatial handling of individual city districts as well. The development in height of the topography benefits, for example, terraces and platforms, whose elevations offer opportunities to construct spacious staircases or to convert high-lying points into theatrical outlooks. A city benefits from a waterside location when it turns its face towards the water; it arrives at an expressive design through a public waterside promenade, and suitable residential building types profit from such locations. Striking places in landscape can be made accessible through footbridges, bridges and platforms.

Architecture is perceived differently on an urban > scale than on that of the individual building, and moreover from various perspectives. As a rule, the expanded circumference of a metropolitan urban region is not graspable, especially in instances of the vast dimensions of a megalopolis. Residents tend to rely > orientation on a simplifying individual conception, on a mental 'image of the city' (Lynch 1960). However, there have always existed official images designed to offer a valid overview of the cityscape (*vedute*) from a distance, complete with the landscape setting. Today, it is > images that circulate in city marketing in particular that attempt to capture a city's characteristic features, condensing its complexity into a unified image.

3. Corresponding to the city is a unique form of situative experience. It is perceived differently from the centre than from individual urban quarters or suburban districts. Generally, it is experienced in the form of situations having various characters, depending upon motivation and mode of movement. From moving vehicles, the architecture of the city is reduced to a specific perceptual segment, while the pedestrian establishes a sense of familiarity with it based on an idiosyncratic interpretation of its spatial structure, a highly personal mode of reading. An urban form of movement is the goal-

directed traversal of space in order to conduct specific transactions. It is oriented towards a network of routes, streets and axes, is guided between nodes, foci and landmarks, which take the form of the system orientation described by Kevin Lynch, for example. Another typical form of movement in the city is a leisurely strolling which carries the individual onward aimlessly, and which actualize different possibilities of spatial order through a kind of > roaming. In essence, individual decisions concerning movement through the city open up a broader spectrum of spatial possibilities than those that are possible within an individual building.

Literature: Certeau 2011; Janson/Wolfrum 2008; Lynch 1960; Rossi 1966/1982; Rowe/Koetter 1978

Use

The specific ‘content’ of architectural forms is use. Accordingly, a building is perceived variously depending on what it is used for, such as whether it is habitable or not. Intended use is among the primary motivations that defines a > situation. Confronted with an empty room, we take in very different features depending upon whether we plan to make it a work-room or a child’s bedroom. One and the same landscape looks very different when regarded as a park than it does when seen as a building site. Advancing into the foreground depending upon our perspective are characteristic features that are likely to facilitate or interfere with its intended utilization. Even ostensibly non-functional elements may offer themselves as objects of use: a ledge as a storage shelf, or the base of the column as a seat.

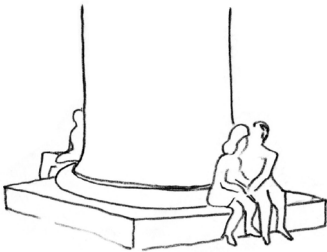

Regarded from the perspective of use, we perceive our spatial surroundings as a ‘space of function’ or as a ‘space of action’ (Dürckheim 2005). Neither forms nor dimensions are primary features, but the accessibility and locatability of objects within an ordered spatial context that is oriented towards use. The nature of architecture that reveals itself through use is not determined through function in the sense

of purely practical purposefulness or specialized technical requirements. Instead, architectural function also involves mental and emotional dimensions.

Apart from highly specialized functions, purpose in a broader sense rests mainly on generalized, repeatable patterns of action. Angelika Jäkel (2013) refers to the thematically closed units that emerge through them, including being seated, getting up, and entering, as ‘figures of action’, and orders them by spatial shapes in relation to specific gestures. A specific form of entryway, for example, corresponds to a certain mode of entrance, a staircase design or seating arrangement to a specific mode of ascending or sitting down. The components of such figures of action, in turn, are separate stages of movement and grasping actions, for example that of opening a door or window, or of emptying or filling a cabinet. Architectural forms and details respond to these elements of movement through manifest design features and through operability and ease of use. A functional design invites use, rendering it pleasant and efficient. This is however not always true for ‘functionalist’ design, which may even hinder use, and may indeed express a specific interest in form through an outwardly functional appearance.

That most figures of action are distinguished principally through characteristic > figures or structures of movement is also true – as Paul Zucker has pointed out – for more complex forms of architectural use: the objective of architectural design is not the space of the church, but the ceremony; not the salesroom, but the marketing of commodities, the stream of purchasers. ‘It is always a question of a temporal process, of the succession of individual spatial components. To regulate the conjunction between these components, the spatial fixation of their temporal rhythm, is the real task of the architect, the object of his powers of design.’ (1925, 87)

More comprehensive spatial uses also consist of a few continuously recurrent and universal patterns of action that correspond to features of spatial design and characteristics

of form. In order to gather, whether at meal times, at conferences, a celebration, or a game, we tend to prefer centring spatial orders; for public presentations, whether film screening, concert, lecture or sermon, a directional spatial structure is the rule; a dispersed spatial order is generally found more suitable for facilitating movement between exhibited objects, in a department store, a museum, a trade fair, or a flower garden. Where a comprehensive programme of use, with its characteristic sequences of movements, permeates an entire building, and is also endowed with gestural expression through the overall design, it is capable of putting its stamp on the architecture as a whole. Dagobert Frey (1925/1946) has said that as the 'content' of an architectural ensemble, the 'utilitarian aspect' of use is capable of 'becoming aesthetically valuable'. The visual appearance of a railway station, a library or a kitchen is not its primary architectural feature. Inherent in their processes of use instead is aesthetic value, i.e. to the extent that we experience them through shaped styles of movement, accented forms of illumination, orienting view axes, and appropriate ambience.

In architecture, then, every form of use can be regarded at least generally as a form of > dwelling, which is then differentiated in various directions. A monofunctional design, on the other hand, must take into account that every putative functional form continually evokes alternative functions or provides a stimulus to creative misuse. Form and use engender one another reciprocally. Buildings that have lost their original functions are often suitable for new and unanticipated utilizations, and are more likely to incite or inspire conversions the less they were originally defined too explicitly by fixed and legible forms of uses.

The neutral multiuse space, in any event, does not correspond to the complexity of use in architecture. Architectural > capacity is revealed far more in the interplay between the two factors of room for manoeuvre and *Prägnanz*. On the one hand, spaces having functional capacity offer a selection of

possibilities; on the other, they set limits to these possibilities, and are not suitable for all purposes. They do not predetermine use according to specific standards, but endow it with a specific spatial character.

Literature: Alexander et al. 1977; Führ 2002

Vaulting	> ceiling, hall, roof
Velocity	> gaze, landscape, movement, route, urban design
Verticality	> body (human), form character, directedness, gaze, heaviness and lightness, postures, staircase, symmetry, tectonics, tower
Vestibule	> courtyard, intermediate space, inversion, square and street
View	> gaze, sensory perception
View axis	> axis, depth, dramaturgy, garden

Views into/out of

Besides providing illumination, the architectural significance of > windows and some other openings is their provision of views into an outside of a building, their function as double-sided visual trajectories for overcoming spatial division. Underlying the act of looking into and out of a building is not only the opposition between interior and exterior, closedness and openness, but in particular the opposition between the two directions: into and out of. Each of these, in turn, is itself experienced as ambivalent. A view into a building or interior room indulges our curiosity, is stimulated by the thrill of fantasy, but also contains a moment of intrusiveness, of threat or aggression.

In directing the gaze towards the outside, we take part actively in the external surroundings, perhaps, emerging only tentatively from our protective container, risking a cautious glance. Corresponding to this are the opposed attitudes of those who gaze and those who are exposed to the gaze.

A view into the interior of a residence through an > opening that breaks open the separation and the protection of the private realm pierces a barrier and risks damaging the inti-

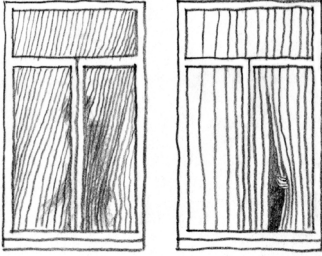

mate sphere. The limitation of the gaze through narrow wings of the opening, drapery and > filters may stimulate fantasy allowing us to imagine what is taking place behind frames and curtains. The view towards the inside becomes a stealthy penetration by the covert gaze into a hidden inner scene that is framed by the window like an > image.

For occupants, privacy generally means enjoying views towards the outside without being visible themselves. An aperture in a room represents an ambivalent form of connection. To freely admit views from the outside either presupposes unconcerned openness, as in Dutch culture, or an attitude somewhere between self-display and shamelessness. Sometimes large openings tend to expose the interior almost to exhibit it behind the expansive windowpane. As in a display window, something is shown openly to the gaze, albeit without any possibility of a real connection or access. The view inside, however, can also serve to announce (> intimation) the interior prior to entrance, either presenting it openly through a frame that guides the gaze, or in the form of a small sample that peeps out through a narrow opening. A view into spaces that are public in character is a mode of participation in internal activities, and connects zones having various degrees of publicness.

For both views into and out of buildings, contrasting illumination plays a role. In broad daylight, a view from the outside into even a relatively well-lit interior causes it to resemble a dark chamber; at night-time, conversely, an illuminated interior viewed from the outside seems to concentrate > light. For a gaze from inside a room, the outdoor space, illuminated by daylight, expands, while views towards the outside into the dark, compact and dense space of the night make the bright interior seem to expand by comparison.

Extreme forms of the views towards the outside are the demonstrative appearance, and observation from a hiding place. The spectrum of situations extends from the gesture of opening towards the world, i.e. a new day in the morning,

to taking part in public events, to cosy, protected, reclining in the window, all the way to cautious, restrained lurking from a place of concealment to gain information or observe goings-on unobserved. Essentially, we feel hemmed in, in rooms of daily use that are deprived of the possibility of comfortable views towards the outside. A view of the sky through a skylight does not correspond to our principal, i.e. horizontal orientation. Decisive for the quality of a view towards the outside is what we see through it, the direction of the opening's orientation, and the view of the > context of the city and landscape it offers. The environment of an apartment, for example, is essentially shaped by the image that is projected into the room in the form of a view onto a selected section of the outer world. The viewing position within the building and its structural shaping also play a role for the possibility of participation in public events, for gaining an overview, and for options for retreat: whether one enjoys a view towards the outside from the depths of the room or only after stepping up to the window or on a balcony; whether one enjoys a broad vista from above, or looks out at street level, but also the levels of railings, the sizes of windows and their formats (vertical or horizontal) and the presence of filters: all of these factors guide the gaze. Through the increasing expansion of the visible area, the drama of the vista is heightened from the roof terrace to the lookout tower to the mountaintop, in ever more exposed situations. At times, a view of remarkable surroundings is enhanced when the view is initially screened off, and offered to our dramatically heightened attention only through a small aperture in a secluded location.

Virtuality

Actually, architectural space is always virtual. Architectural space is the way in which built space is experienced, its impact. It is a conception of space that initially guides the design, and finally, allows a spatial > concept and an > order to become recognizable in the architectural result. Virtuality

(Latin: *virtus*, adeptness, fitness) encompasses all of those phenomena and features that, while not physically graspable, are nonetheless essential to architecture, in particular its spatial > atmosphere, > gesture, and the guiding of > movement. At the elementary level of simple perception already, we experience architecture virtually in the sense that it conveys to us some conception of its possibilities for interaction and movement and of its spaces, even before we actually lay claim to them. It facilitates orientation and provides us with some conception of visually inaccessible areas, for example those behind our backs, or on the other side of walls. All > form characters, whether weighty, floating, receptive or forbidding, are virtual. Virtual as well, finally, are all types of feeling for space and its character, including impressions of > size, narrowness and > expansiveness, > closedness and > directionality, and all corporeal spatial relationships. In many cases, such forms of virtuality shape our interaction with architecture more decisively than its physical properties. Inherent in them is a genuinely fundamental capacity of architecture.

On the other hand, it is a question of exaggeration when virtual effects are used for the sake of perceptual corrections, illusion and deception. Here we find the optical corrections to the architectural elements of the Greek temple, including curvatures in the horizontal or inclinations and entasis in columns, which allow architecture to seem alive. The illusionistic ceiling frescoes of the Baroque allow a closed space to seem open above, bearing the beholder aloft with ecstatic gestures into a celestial realm. In Francesco Borromini's colonnade at Palazzo Spada in Rome, a perspectival illusion is generated by having all of the details of a passageway that narrows as it proceeds progressively reduced in size so that it seems much longer than it actually is. A sense of oppression is triggered by the apparent inescapability of a labyrinth, and bewilderment is achieved by the multiplication of space within a mirrored cabinet by means of mirrored mirror images. In his project for a cenotaph for Newton, Étienne-Louis Boullée wanted to

create the impression during the day of standing beneath the starry heavens of the night sky, by having the shell of a gigantic sphere perforated with holes, thereby admitting light to the darkened space within.

We experience today's widely prevalent virtual reality very differently. This is the term for physically inexistent (three-dimensional) spaces that are calculated by computers and made accessible to subjects experientially through projections of spatial imagery. We speak in this context of immersion, meaning the sensation of actually occupying a physical space, although it exists only as pixels on display screens or monitors. The user plays an active role by having his or her control signals or movements translated simultaneously into corresponding and constantly changing spatial imagery. At this point, however, the experience of real architecture with all of its sensory stimuli and the involvement of real movement, that is to say, the feeling of being 'in a space', cannot be replaced by virtual reality. Gaining in importance, however, is CAD-generated advertising imagery, which anticipates the future realization of architectural works, allowing them to be visited and entered virtually beforehand, and presenting them with such perfection that the actual buildings may have difficult competing.

- Vision** > gaze, sensory perception
- Vista** > depth, gaze, intimation, perspective, sequence
- Visual target** > axis, depth, directionality, gaze, route, sequence

- Walking** > arcade, movement, rhythm (spatial), route, sequence

- Wall** The remarkable thing about walls is that although they are directly in front of us, most of the time, we have no notion of what is going on just a few feet behind them. On the one

hand, the wall is only a two-dimensional image plane upon which we perceive light and shadow or various types of information; and as spatial containers, walls appear to be flat elements that lack depth. On the other hand, however, they form three-dimensional rooms of various depths. Walls contain and divide rooms, or lead from one to the next; depending upon the directionality of the gaze and of movement, they either offer solid resistance or guide us inconspicuously along our way. At times, they are dissolved into individual elements, into supports, > columns or pillars. Walls represent physical counterparts (1); according to their physical constitutions (2); they also function as spatial delimitations (3); and serve in manifold ways to shape space (4).

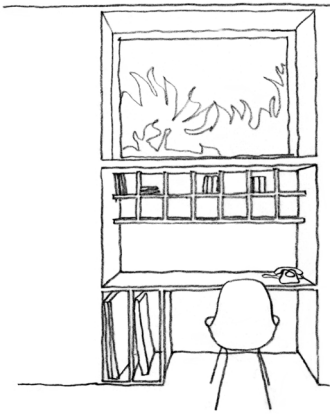

1. While the > ground is the field of action for our movements, vertical walls are an impassable vis-à-vis for the roaming > gaze, the image plane upon which, provided it is empty, our fantasy may cause imaginary figures to appear. The wall confronts us with the counterpart to our own bodies; within it, spatial limitations are objectified. We seldom actually touch walls; nonetheless, the projection of our bodily zones corresponds to a virtual subdivision of the wall into an area of vision at eye level, an area for kicking near the legs, and an area of the grasp beginning at waist level and extending above the head. Accordingly, wall coverings are applied, storage units and shelves installed, and pictures hung. As a result, the wall becomes an information service and storage zone, and consequently becomes so obstructed and obscured that one sees precious little of it. When it is kept free of obstructions, on the other hand, it can serve as a projection surface for the play of light and shadow. But bare walls are also a stimulus to fantasy, eliciting a desire to decorate them. Through murals, ornamentation or incrustation, they become viewing and exhibition surfaces. As > facades, they are both information panels that convey or withhold statements about a building's interior and planar compositions that are subject to the laws of proportion and weight balance; through horizontal

and vertical articulation, they give expression to tranquil constancy or gestural animation.

While we cannot escape the ground, nor perhaps reach the ceiling, the wall allows us freedom of movement; we can approach it, distance ourselves from it, or adopt a variety of positions in relation to it. It becomes the backdrop to a > scene, a framed background for that which occurs in front of it, and provides opportunities for withdrawal or concealment behind it. In the Middle Ages, the primitive travelling theatre consisted of nothing more than a plain wall curtain set up on a wooden floor. When using a room, locations with a wall towards the back are preferred, because it is said to 'cover one's back' while also serving as a support. Even when not leaning against it, we find its verticality reassuring – a quality that is lost when it is slanted, since then, we risk a collision, whether with our feet or our heads. Through its physical mass, it offers stability. But since it also offers resistance to our bodies, it can also be experienced as an obstacle when positioned directly in front of us.

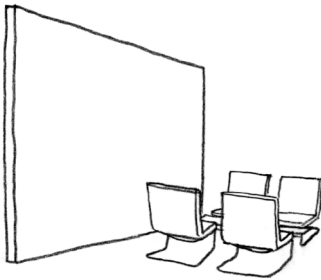

2. The apparent stability of thin walls is reminiscent of the masonry wall. A masonry wall is solid, thick and heavy, is generally constructed of brick or stone, and stands or lies on the ground, while other types of walls may also be hung or suspended. Gottfried Semper believed he had discovered the tectonic origin of the wall in the covering of a space frame with textiles or carpets; he claimed that the word *Wand* (German for 'wall') could be derived from the word *Gewand* (German for 'garment'). By means of cladding or facing (> covering), even the masonry wall can assume this character, and light walls may take on greater mass and strength through additional layering. The structure and corporeal quality of walls becomes visible in > openings and embrasures which expose them in section, and which may even be expanded to become > space-containing walls.

3. As soon as walls assume their genuine task, that of delimiting rooms, their dual role comes into play: 'Seen from

within, they are simply given; seen from without, they are made by human hands.' (Flusser 1993b) A wall simultaneously excludes and encloses, but we only ever stand on one side of it. As a rule, the inner and outer side of the wall is not even present within the same perceptual image. It is difficult to identify the inner side of a wall as the back of a facade. In an indefinite fashion, we nonetheless strive to imagine what is going on beyond an enclosing inner wall, or conversely inside, behind an outer wall. While we exploit our sense of fantasy in order to project a virtual space that exists beyond the wall, we project conceptions about our individual lives on the near side of inner walls in the form of coverings and decoration; on outer walls, we project our desired appearance in the world through emblematic facade design.

The wall is a universal foil for both, as long as it remains unobtrusively available for a variety of projections and treatments. As a vertical > plane, it forms a self-evident backdrop for such projections. If, however, it becomes independent through free formation or plastic articulation, it begins to call attention to itself as sculpture. Originally an impermeable spatial boundary, the wall sacrifices this function with increasing levels of perforation or dissolution by openings. A house without walls sacrifices the enthralling interplay of concealment and exposure. Of course, glass surfaces may be regarded as transparent dividing walls, and when subdivided by sashes, assume the appearance of a picture plane bearing a network of coordinates; but they serve rather the function of > filters. This is true as well for rows and columns, although Leon Battista Alberti regarded them as being merely walls with interruptions. For Louis I. Kahn, such interruptions can serve as a decisive resource for facilitating the play of light and darkness.

4. The individual wall renounces its independence as soon as it joins together with multiple planes. By forming an > angle, two walls begin to enclose an interior. A field of spatial tension results between the two when they face one another.

other. Generated by a wall in conjunction with the floor is a > space shadow. In their most sparing form, the proverbial four walls contain the introverted container of the > cell, but are also essential to the amenity qualities of the city as the walls of > squares and streets. Walls influence the character of a room, and our state of mind when > inside it (> concavity). With an increasing complexity of the spatial configuration, walls assume the multifarious tasks of enclosing, articulating and guiding, for they extend the plan vertically. At the same time, they mask it, for our bodily disposition refuses us an overview; we find ourselves consistently facing walls that capture our movements and gazes. These hinder a rational comprehension of the plan, blocking vistas, obstructing access, misleading us, only subsequently to open up astonishing connections and perspectives, when the structural order finally becomes intuitively discernible. In extreme instances, walls become the decisive elements of the labyrinth. Walls perform a modest service, on the other hand, when they simply catch the > light within a room, allowing it to become visible through its distribution on the wall surface in interplay with shadow.

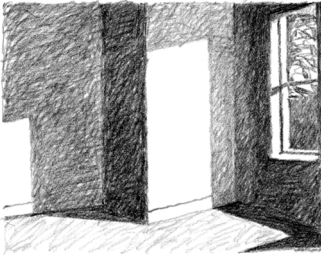

Warmth and cold

The significance of warmth in architecture is not limited to the provision of heating according to accepted standards. This, of course, respects the expectation of occupants, who consider it an intrinsic task of the building to provide the necessary warmth along with protection and privacy. In opposition to such a determination, however, it was precisely coldness that came to be valued as an architectural ideal by the Modernist avant-garde. As Helmut Lethen (1994) has shown, the cult of coldness was on the one hand a metaphor for the renunciation of the warmth and shelter of family, religion and cultural heritage, and a bold and unshielded embrace of the civilizational upheavals of modernity. On an architectonic level, on the other, the ideal of coldness demanded an ap-

proach to interior design and home decor that turned against the plush, upholstered interiors and stuffy atmosphere of the overheated bourgeois parlours of the nineteenth century. The concrete physical and synaesthetic impact of the withdrawal of warmth through the rejection of cladding and the introduction of naked walls, expansive glazing, the exposure of light sources, and the 'exposure of functional elements' (Lethen 1994), as well as through the thermal conductivity of tubular steel furniture and glass, was to make coldness accessible to both sensory and emotional experience. Thus, coldness was associated with veracity, realism and intellectual asceticism.

The fascination for coldness stood in opposition to widely diffused notions of architecture as providing security and warmth. But today, even our requirement for warmth has no absolute validity, but must be regarded in a differentiated way. Aside from the fact that there are times when the individual requires cooling down, we prize warmth when it is required, not continuously and everywhere to the same degree. Just as a warm room is perceived as pleasanter when it is cold outside, the warmer rooms or islands of warmth within a home receive their special value in relation to cooler zones. The fire in the hearth can only serve as a focused source of warmth when it is a contrast to the rest of the room; only in a cool room can we enjoy snuggling near the stove. Areas of a room where one sits before sunlit wall surfaces that radiate warmth exploit the effects offered by islands of warmth and light simultaneously. Just as architecture requires the differentiated distribution of bright and dark zones, only graduated temperature zones provide the appropriate conditions for various activities and intensities of movement.

We perceive warmth and cold in particular through the skin (through warmth and cold receptors). In the cold, we often shrink into ourselves, reducing the surface area of our bodies, or huddle against others, thereby occupying less space. Under such circumstances, a small room suffices. When

it is warm, in contrast, we expose larger areas of the body, spreading ourselves out in order to maximize contact with the air; we prefer places where we can occupy more space. In architecture, we experience temperature through ambient air and thermal radiation, but also through touch. Through material qualities in particular, warm or cold surfaces convey expressive qualities through their contrast with our own body temperature, contributing to special atmosphere and to the impression made by objects. They make it possible, for example, to create attractive cool areas in the warmer rooms. Particularly effective are impressions of warmth generated by > synaesthesia, effects that emanate from warm or cold materials, > light and > colours. The clichés of ‘warm’ wood and ‘cold’ steel, however, are not always accurate. Wood, to be sure, has less heat conductivity than steel, but need not necessarily be suggestive of warmth. Such effects are dependent upon the type of wood and its treatment, e.g. smooth finish, high-gloss paint, or sharply angular forms. Indeed, the synaesthetically transferred effects of warmth or coldness become fully efficient only when they are supported by corresponding real temperatures.

Weight

> form character, heaviness and lightness

Window

Alongside the preeminent significance of the window for > views into and out of buildings and for admitting > light into interior spaces, physical characteristics also contribute to the way in which we perceive and experience it; relevant aspects include the windowpane’s function as a membrane (1), the significance of the window frame and its extensions (2), the placement of the window within a room (3), and the acts of opening and closing (4).

1. The plane of the window determines the placement of the separating and connecting pivot between interior and

exterior, and through the windowpane, forms a membrane where views into and out of buildings converge and are separated from one another. For both, it is the diaphragm, the materialized and framed pictorial plane that is inserted between views into and out of buildings, but also where delimited images of interior or exterior spaces are inserted as though on a display screen. The window distances us from the space on the other side, allowing us to see into it, but providing no direct access. Inherent to window and glass is an ambivalence between permeability and reflection (> transparency); it can appear as a dark surface, a black, secretive aperture in the facade, or may mirror its surroundings, integrating the building into its setting, offering views of adjacent structures. In the night-time, illuminated windows function like eyes, enlivening the street with its own dynamism. The role of the plane of the window as a projection surface is emphasized by mullion and transom, when they are perceived as the constructive scaffolding of a perspectival scheme on the picture plane, or as the coordinates of a matrix. A finer subdivision of the window plane superimposes a latticework before views of the outside, fragmenting it into facets; now, the membrane becomes a > filter, especially when blinds, curtains or coloured glazing are involved as well.

2. Depending upon the format, the delimitation of the field of vision through the frame generates a different > perspective. Through the respective framing, the exterior world, which is accessible through the window only indirectly, is interpreted selectively: the upright rectangle of the French window (French: *porte-fenêtre*) allows the gaze to wander from the foreground of the street to the buildings opposite, and up towards the sky, thereby offering a more or less representative cross-section of the staggered exterior space. Corresponding in its proportions to the contours of a standing human figure (Auguste Perret: 'une fenêtre c'est un homme, c'est debout'), the window makes it possible to step out without abandoning one's position, taking a small step to stand halfway out-

side, while remaining protected from the danger of falling; the frame contains the human figure like a picture frame, isolating and displaying it. The horizontal panorama or strip window, on the other hand, Le Corbusier's *fenêtre en longueur*, already allows the gaze to sweep from the inside out (Le Corbusier: 'L'oeil regarde horizontalement'). Here, the lateral delimitations may lie outside the field of vision, allowing the distancing effect of being inside to dissipate and the exterior space to penetrate without transition into the interior, fusing with it.

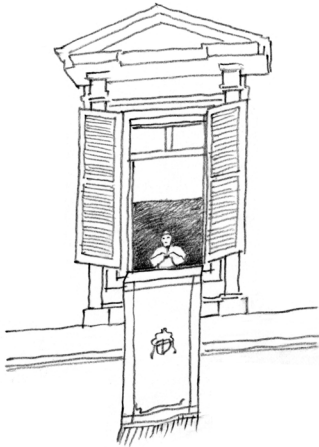

The > image that is framed by the window is infused with meaning by the framing device: seen from the outside, as with the papal window or images of overheard intimacy, like the subjects of the genre of the window painting in art; seen from the inside as a framed landscape that is staged by the choice of the limitations and by appropriate positioning within the room, to which the theatrical drapery of a curtain may also contribute. The contents of these images are determined by the positions of windows, both in relation to the exterior (street front, unedifying rear view, or landscape), and by action sequences enacted in the interior (depending upon the plan), and the resultant conditions shaping views to the outside. In a permanent dwelling, in any event, the image formed by a view to the outside as a section of the world contributes substantially to one's picture of the surrounding environment. This becomes strikingly evident when we change the room where we spend the greater portion of our time within a building or apartment.

3. The relationship of the window to the room begins with the > wall. It may form an > opening as a sharp incision, or be continuous with the wall through slanted embrasures, offering minimal contrastive illumination, or through flowing transition to clad walls via curtains. Regardless, the constriction of the visual field calls upon us either to approach the window or to seek a suitable position within the room in relation to the placement and size of the window to optimize

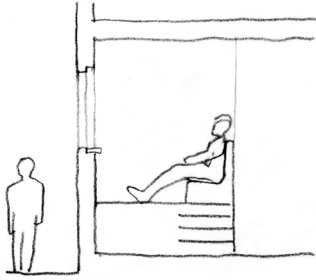

viewing conditions. This depends upon whether we only want to see out, or instead wish to be seen from the outside; one may even prefer to sit at a window without really looking through it. Since we are attracted by the light and the view, we seek out a direct connection to the window. In order to unite it seamlessly with seating, we require a fixed, permanent window seat, possibly in a deep niche as an independent window space. On the ground floor as well, a raised window seat with elevated railing permits views towards the outside without risking exposure. A bay window, or a > gallery as 'display case' situated in front, also provides side views along the street. Like the corner window, it offers the advantage of admitting light from more than one side; in a spatial > inversion, one is inside and yet surrounded by light and external space.

4. We experience the act of opening and closing differently depending upon how the window is configured, and how it operates. A double-leaved window that opens outward requires us to open our arms and spread them out towards the external space in a receptive gesture. Such a window closes like an article of clothing that buttons in the front. If it opens towards the inside, the gesture of opening figuratively speaking involves drawing the outer world towards oneself along with the leaves of the window. As a rule, the casements then project at an angle into the room, forming a kind of triptych whose middle part is formed by the view towards the outside, supplemented by the lateral elements, each of which mirrors portions of the outer world. During the act of closure, this gesture is reversed, as wind and weather are pushed away towards the outside. Large single-leaf casements, conversely, project so far into the room that they divide it and interfere with movement through space.

Provided that the mechanism to be operated is simple, we develop a relationship of familiarity with the act of opening and closure. With complicated mechanisms, on the other hand, we readily become slaves of the apparatus, and lose our

direct access to this elementary pairing of gestures.

Literature: Hasler 1997; Mäckler 2006; Posener 1981; Selle 2004

Workplace

> access, capacity, furnishing, use

Zoning

> ceiling, flowing space, ground, light, screening, opening, spatial structure, residence, use, warmth and cold

Bibliography

- Adorno, Theodor W. (1979) 'Functionalism Today,' *Oppositions* no. 17, 31–41
- Alberti, Leon Battista (1485/1975) *De re aedificatoria*, Munich
- Alberti, Leon Battista (1991) *On the Art of Building in Ten Books*, Cambridge, MA
- Alexander, Christopher, et al. (1977) *A Pattern Language. Towns. Buildings. Construction*. New York
- Ando, Tadao (1988) 'Shintai and Space,' in Scott Marble et al. (eds.), *Architecture and Body*, New York
- Arnheim, Rudolf (1972) *Visual Thinking*, Berkeley and Los Angeles
- Arnheim, Rudolf (1977/2009) *The Dynamics of Architectural Form*, Berkeley and Los Angeles
- Arnheim, Rudolf (1998) 'Das Bauwerk als Anschauung. Buildings as Thoughtful Vision,' *Daidalos* no. 67, 26–31
- Auer, Gerhard (1989) 'Begehrlicher Blick und die List des Schleiers. The Desiring Gaze and the Ruses of the Veil,' *Daidalos* no. 33, 36–53
- Augé, Marc (2009) *Non-Places: An Introduction to Supermodernity*, London *Poetics of Space*, Boston
- Baecker, Dirk (1990) 'Die Dekonstruktion der Schachtel. Innen und Außen in der Architektur,' in Niklas Luhmann et al., *Unbeobachtbare Welt: Über Kunst und Architektur*, Bielefeld, 67–104
- Baier, Franz Xaver (1996) *Raum: Prolegomena zu einer Architektur des gelebten Raumes*, Cologne
- Baudrillard, Jean (1968/2006) *The System of Things*, London
- Benjamin, Walter (1933/1999) 'Experience and Poverty,' in *Walter Benjamin: Selected Writings, vol. 2., 1927–1934*, Cambridge, MA
- Benjamin, Walter (1936, 2006) 'The Work of Art in the Age of Its Technical Reproducibility,' in *Walter Benjamin: Selected Writings, vol. 3: 1935–1938*, MA
- Benjamin, Walter (1982/2002) *The Arcades Project*, Rolf Tiedemann (ed.), Cambridge, MA
- Bergson, Henri (1896/1911) *Matter and Memory*, New York
- Berndt, Heide, et al. (1977) *Das Prinzip Reihung in der Architektur*, Dortmunder Architekturtag, 1975, Dortmund
- Beyer, Silvia; Huber, Ines (2000) 'Im Reich der Sinne. Permeabilität und Intimität der traditionellen japanischen Architektur,' *Archithese* no. 6, 12–19
- Bischoff, Werner (2006) 'Grenzenlose Räume' – Überlegungen zum Verhältnis von Architektur und städtischem Geruchsraum,' *Wolkenkuckucksheim* no. 2. *Body, Memory, and Architecture*, New Haven and London
- Bloomer, Kent C.; Moore, Charles W. (1977) *Le Corbusiers Wege – Wie das Zauberwerk in Gang gesetzt wird*, Braunschweig
- Blum, Elisabeth (1980) *Le Corbusiers Wege – Wie das Zauberwerk in Gang gesetzt wird*, Braunschweig
- Böhme, Gernot (1995a) *Atmosphäre. Essays zur neuen Ästhetik*, Frankfurt/M
- Böhme, Gernot (1995b) 'Inszenierte Materialität. Staged Materiality,' *Daidalos* no. 56, 36–44
- Böhme, Gernot (1998) *Anmutungen. Über das Atmosphärische*, Ostfildern

- Böhme, Gernot (2001) *Asthetik. Vorlesungen über Ästhetik als allgemeine Wahrnehmungslehre*, Munich
- Böhme, Gernot (2006) *Architektur und Atmosphäre*, Munich
- Bollnow, Otto Friedrich (1963) *Mensch und Raum*, Stuttgart, Berlin, Cologne, Mainz
- Boss, Medard (1975) 'Grundzüge des Menschseins. Die Räumlichkeit des Daseins,' in idem, *Grund-Grundriss der Medizin und der Psychologie*, Bern, Stuttgart, Vienna, 230–320
- Boudon, Philippe (1991) *Der architektonische Raum. Über das Verhältnis von Bauen und Erkennen*, Basel, Berlin, Boston
- Boullée, Étienne-Louis (1987) *Architektur. Abhandlung über die Kunst*, Beat Wyss (ed.), Zurich, Munich
- Brinckmann, Albert Erich (1924) *Plastik und Raum als Grundformen künstlerischer Gestaltung*, 2nd expanded edition, Munich
- Brinckmann, Albert Erich (1956) *Baukunst. Die künstlerischen Werte im Werk des Architekten*, Tübingen
- Büttiker, Urs (1994) *Louis I. Kahn: Licht und Raum. Light and Space*, Basel, Berlin, Boston
- Burren, Barbara, et al. (2008) *Das schräge Dach. Ein Architekturhandbuch*, Sulgen, Zurich
- Certeau, Michel de (2011) *The Practice of Everyday Life*, Berkeley and Los Angeles
- Cullen, Gordon (1961/1971) *The Concise Townscape*, London, Beccles and Colchester
- Debord, Guy (1958) 'Théorie de la dérive,' *Internationale Situationniste* no. 2
- Dürckheim, Graf Karlfried von (2005) *Untersuchungen zum gelebten Raum. Erlebniswirklichkeit und ihr Verständnis. Systematische Untersuchungen II (1932)*. Jürgen Hasse (ed.), Frankfurt/M
- Eco, Umberto (1986) 'Function and Sign: Semiotics of Architecture', *The City and the Sign: An Introduction to Urban Semiotics*, Mark Gottdiener (ed.), New York
- Eickhoff, Hajo (1993) *Himmelsthron und Schaukelstuhl. Die Geschichte des Sitzens*, Munich
- Eisenman, Peter (1989) *Guardiola House*, ed. Aedes Galerie für Architektur und Raum, Berlin (un-paginated)
- Evans, Robin (1996) 'Menschen, Türen, Korridore,' *Arch+* nos. 134/135, 85–97
- Feldtkeller, Christoph (1989) *Der architektonische Raum: eine Fiktion. Annäherung an eine funktionale Betrachtung*, Braunschweig, Wiesbaden
- Fischer, Theodor (1934) *Zwei Vorträge über Proportionen*, Munich
- Flusser, Vilém (1993a) *Dinge und Undinge. Phänomenologische Skizzen*, Munich
- Flusser, Vilém (1993b) *Der Stand der Dinge*, Göttingen
- Frampton, Kenneth (1993) *Studies in Tectonic Culture: The Poetics of Construction in Nineteenth and Twentieth Century Architecture*, Cambridge, MA
- Franck, Dorothea; Franck, Georg (2008) *Architektonische Qualität*, Munich
- Frank, Josef (1995) 'Das Haus als Weg und Platz,' in idem, *Architektur*, Basel, 120–131
- Frankl, Paul (1908) 'Raum und Zweck,' *Die Raumkunst* no. 11, 171–174
- Frey, Dagobert (1925/1946) 'Wesensbestimmung der Architektur,' in *Grundfragen. Prolegomena zu einer Kunstphilosophie*, Vienna 1946, 93–106
- Frey, Dagobert (1976) 'Zum Problem der Symmetrie in der bildenden Kunst,' in idem, *Bausteine zu einer Philosophie der Kunst*, Darmstadt, 233–259

- Friedrich, Thomas; Gleiter, Jörg (ed.) (2007) *Einführung und phänomenologische Reduktion. Grundlagentexte zu Architektur, Design und Kunst*, Berlin
- Frieling, Heinrich (1969) 'Farben im Raum,' *Bauwelt* no. 18, 617–623
- Führ, Eduard (2002) 'Frankfurter Küche' und Spaghetti carbonara. Funktionalität von Architektur und Kunst des Gebrauchs,' in *Ausdruck und Gebrauch* no. 1
- Giedion, Siegfried (1965/1982) *Space, Time and Architecture: The Growth of the New Tradition*, Cambridge, MA
- Giersch, Ulrich (1983) 'Auf Stufen. On Steps,' *Daidalos* no. 9, 23–33
- Gleiter, Jörg (2002) *Rückkehr des Verdrängten. Zur kritischen Theorie des Ornaments in der architektonischen Moderne*, Weimar
- Goethe, Johann Wolfgang von (1786/1988) Diary entry, Verona, 16 September 1786, and Vicenza, 21 September 1786, evening, in idem, *Italienische Reise*. Hamburg edition, Munich 40, 55
- Goethe, Johann Wolfgang von (1795/1973) 'Baukunst (1795). Paralipomena (Grundlage zu einer architektonischen Bibliothek)' (1797), in idem, *Kunsttheoretische Schriften und Übersetzungen. Schriften zur bildenden Kunst I*, Berlin edition, vol. 19. Berlin 1973, 107–125
- Gosztonyi, Alexander (1976) *Der Raum. Geschichte seiner Probleme in Philosophie und Wissenschaften*, Freiburg, Munich
- Hajek, Stefan (2009) 'Das Konkrete, das Abstrakte und das Haptische,' *Wolkenkuckucksheim* no. 1
- Halbwachs, Maurice (1985) *Das kollektive Gedächtnis*, Frankfurt/M
- Hall, Edward T. (1966) *The Hidden Dimension*, New York
- Hanimann, Josef (1999) *Vom Schweren. Ein geheimes Thema der Moderne*, Munich, Vienna
- Hasler, Thomas (1997) 'Das Fenster und seine Gestik auf den Raum. Zur Beziehung von Öffnung und Innenraum,' *Archithese* no. 5, 14–19
- Hasler, Thomas (2000) *Architektur als Ausdruck – Rudolf Schwarz*, Zurich, Berlin
- Hasse, Jürgen (2005) *Fundsachen der Sinne. Eine phänomenologische Revision alltäglichen Erlebens*, Munich
- Hegel, Georg Wilhelm Friedrich (1993) *Introductory Lectures on Aesthetics*, Michael Inwood (ed.)
- Heidegger, Martin (1927/2008) *Being and Time*, New York
- Heidegger, Martin (1953/2008) 'Building, Dwelling, Thinking,' in *Poetry, Language, Thought*, New York, 141–160
- Heidegger, Martin (1979) *Vorlesungen 1923–1944. Prolegomena zur Geschichte des Zeitbegriffs*, completed edition vol. 20, sec. 2, Frankfurt/M
- Heraclitus, of Ephesus (1889) 'The Fragments of the Work of Heraclitus of Ephesus on Nature,' (dissertation), Baltimore
- Hertzberger, Herman (1991) *Lessons for Students in Architecture* (1), Rotterdam
- Hertzberger, Herman (2000) *Space and the Architect. Lessons in Architecture* (2), Rotterdam
- Hirschfeld, Christian Cay Laurenz (1779/1990) *Theorie der Gartenkunst*, Berlin

- Hoesli, Bernhard (1997) 'Addendum,' in Colin Rowe, Robert Slutzky, *Transparency*, Basel, Boston, Berlin, 84–119
- Hofer, Paul (1979) 'Materialien eines dialogischen Stadtentwurfs: 1. Antiurbane und urbane Stadtgestalt,' *Werk-Archithese* nos. 33–34, 23–27
- Holenstein, Elmar (1985) *Menschliches Selbstverständnis. Ichbewußtsein – Intersubjektive Verantwortung – Interkulturelle Verständigung*, Frankfurt/M
- Jäkel, Angelika (2013) *Gestik des Raumes. Zur leiblichen Kommunikation zwischen Benutzer und Raum in der Architektur*, Tübingen, Berlin
- Janson, Alban (1999) 'Architektur ist Entwurf,' in *Wolkenkuckucksheim* no. 1
- Janson, Alban (2003) 'Schwärze/Blackness,' in Susanne Kohte and Galerie Renate Kammer (eds.), *Hiroshi Nakao. Leib. Raum. Plan, exh. cat.*, Hamburg, 20–27
- Janson, Alban (2005) 'Ein Scherzo in Zitronenholz. Einführung in den Beitrag von Graf Karlfried von Dürckheim aus der Perspektive der Architektur,' in Graf Karlfried von Dürckheim, *Untersuchungen zum gelebten Raum*, ed. Jürgen Hasse, Frankfurt/M, 147–171
- Janson, Alban; Bürklin, Thorsten (2002) *Auftritte/Scenes. Interaktionen mit dem architektonischen Raum: die Campi Venedigs. Interaction with Architectural Space: the Campi of Venice*, Basel, Berlin, Boston
- Janson, Alban; Jäkel, Angelika (2007) *Mit verbundenen Augen durch ein wohlgebautes Haus. Zur szenischen Kapazität von Architektur*, Frankfurt/M
- Janson, Alban; Wolfrum, Sophie (2006) 'Kapazität. Spielraum und Prägnanz,' *Der Architekt* nos. 5–6, 50–54
- Janson, Alban; Wolfrum, Sophie (2008) 'Leben bedeutet zuhause zu sein, wo immer man hingehet,' in Jürgen Hasse (ed.), *Die Stadt als Wohnraum*, Freiburg, Munich, 94–108
- Jantzen, Hans (1957) *Kunst der Gotik*, Hamburg
- Joedicke, Jürgen (1985) *Raum und Form in der Architektur. Space and Form in Architecture*, Stuttgart
- Joedicke, Jürgen; Lauterbach, Heinrich (2001) *Hugo Häring. Schriften Entwürfe Bauten*, Stuttgart
- Judd, Donald (1989) *Architektur*, Münster
- Kambartel, Walter (1972) *Symmetrie und Schönheit*, Munich
- Kant, Immanuel (1790/1971) *Kritik der Urteilskraft (Critique of Pure Reason)*, Gerhard Lehmann (ed.), Stuttgart
- Kemp, Wolfgang (2009) *Architektur analysieren. Eine Einführung in acht Kapiteln*, Munich
- Klages, Ludwig (1944) *Vom Wesen des Rhythmus*, Zurich, Leipzig
- Kleist, Heinrich von (1801/1978) Letter to Ulrike von Kleist, Basel 16 Dec 1801, in idem, *Werke und Briefe in 4 Bänden*, vol. 4, *Briefe*. Berlin, Weimar
- Klopper, Paul (1919) 'Das räumliche Sehen,' *Zeitschrift für Ästhetik und allgemeine Kunstwissenschaft* 13, 135–149
- Köhler, Bettina (2009) 'Jalousie. Schauen, Verbergen, Beschatten, Belüften,' *Arch+* nos. 191/192, Schwellenatlas, March, 64–68

- König, Josef (1957) 'Die Natur der ästhetischen Wirkung,' in Klaus Ziegler (ed.), *Wesen und Wirklichkeit des Menschen (Festschrift für Helmuth Plessner)*, Göttingen, 283–332
- Kollhoff, Hans (ed.) (1993) *Über Tektonik in der Baukunst*, Braunschweig, Wiesbaden
- Koolhaas, Rem; Mau, Bruce (1995) *S,M,L,XL*, Rotterdam
- Koren, Leonard (ed.) (1995) *Wabi-sabi für Künstler, Architekten und Designer. Japans Philosophie der Bescheidenheit*, Tübingen
- Kruse, Lenelis (1974) *Räumliche Umwelt. Die Phänomenologie des räumlichen Verhaltens als Beitrag zu einer psychologischen Umwelttheorie*, Berlin, New York
- Kuhnert, Nikolaus (1979) 'Soziale Elemente der Architektur. Typus und Typusbegriffe im Kontext der Rationalen Architektur' (dissertation)
- Kulka, Heinrich (ed.) (1931) *Adolf Loos. Das Werk des Architekten*, Vienna
- Kwinter, Sanford (1993) 'Das Komplexe und das Singuläre,' *Arch+* nos. 119/120, 77–90
- Laan, Dom Hans van der (1983) *Architectonic space. Fifteen lessons on the disposition of the human habitat*, tr. Richard Padovan, Leiden
- Laban, Rudolf von (1991) *Choreutik. Grundlagen der Harmonielehre des Tanzes*, Wilhelmshaven
- Le Corbusier (1933/1974) 'In Defense of Architecture,' *Oppositions* 4, 79–108
- Le Corbusier (1962/2000) *Talks with Students* ('Charte d'Athènes'), New York
- Le Corbusier (1991) *Precisions on the Present State of Architecture and City Planning*, Cambridge, MA
- Lefèbvre, Henri (1977) 'Die Produktion des städtischen Raums,' *Arch+* no. 34, 52–57
- Lethen, Helmut (1994) *Verhaltenslehren der Kälte. Lebensversuche zwischen den Kriegen*, Frankfurt/M
- Lévi-Strauss, Claude (1963/1976) *Structural Anthropology* vol. 1, New York; vol. 2, Chicago
- Lipps, Theodor (1912) *Psychologische Untersuchungen*, 2 vols., Leipzig
- Loderer, Benedikt (1987) *Stadtwanderers Merkbuch. Begriffsbestimmung 'Stadtraum' am Beispiel Fabriano*, Munich
- Loos, Adolf (2002a) 'The Principle of Cladding,' (1898) in idem, *On Architecture*, Riverside, CA, 42–47
- Loos, Adolf (2002b) 'Learning a New Way of Living,' (1921) in idem, *On Architecture*, Riverside, CA, 164–167
- Loos, Adolf (2002c) 'On Thrift,' (1924) in idem, *On Architecture*, Riverside, CA, 178–183
- Lynch, Kevin (1960) *The Image of the City*, Cambridge, MA
- Lynn, Greg (1993) 'Architectural Curvilinearity: The Folded, the Pliant and the Supple,' *Architectural Design* 63, nos. 3/4, 8–15
- Mäckler, Christoph, et al. (2006) *Dortmunder Architekturtage*, Dortmund Architekturheft 19
- Mäckler, Christoph, et al. (2008) *Stadtbaukunst: Der Hauseingang. Dortmund Architekturtage*, Dortmund Architekturheft 21
- Mäckler, Christoph, et al. (2009) *Stadtbaukunst: Die Treppe. Dortmund Architekturtage*, Dortmund Architekturheft 22

- Maertens, Hermann (1877) *Der optische Maßstab oder die Theorie und Praxis des ästhetischen Sehens in den bildenden Künsten, Bonn*
- Maki, Fumihiko (1979) 'Japanese City Spaces and the Concept of Oku,' *The Japan Architect* no. 5, 51–62
- Meerwein, Gerhard, et al (2007) *Color: Communication in Architectural Space*, Basel, Boston, Berlin
- Meisenheimer, Wolfgang (1964) 'Der Raum in der Architektur. Strukturen, Gestalten, Begriffe' (dissertation, TH Aachen)
- Meisenheimer, Wolfgang (1983) 'Treppen als Bühnen der Raum-Anschauung. Stairs as Stages of Space-Visualization,' *Daidalos* no. 9, 16–22
- Meisenheimer, Wolfgang (2004) *Das Denken des Leibes und der architektonische Raum*, Cologne
- Meiss, Pierre von (1990) *Elements of Architecture: From Form to Place*, London
- Merleau-Ponty, Maurice (1961/1993) 'Eye and Mind,' in Galen A. Johnson (ed.), *The Merleau-Ponty Aesthetics Reader*, Evanston, IL, 121–150
- Merleau-Ponty, Maurice (1962) *Phenomenology of Perception*, London
- Merrill, Michael (2010) *Louis Kahn on the Thoughtful Making of Spaces. The Dominican Motherhouse and a Modern Culture of Space*, Baden
- Meyer, Jochen (1996) 'Die 'Macht der Raumbeziehung'. Maßstabs- und Gestaltungsprobleme des Hochhauses. 'The Power that Subjugates Space': Scalar and Formal Problems of the Tall Building,' *Daidalos* no. 61, 50–60
- Meyer, Jochen (1998) 'Auf dem Wege zu einer architektonischen Auffassung der Architektur. Zur Neuauflage von Hermann Sörgels *Architektur-Ästhetik*,' afterword to Herman Sörgel, *Theorie der Baukunst*. vol. 1: *Architektur-Ästhetik*, Berlin
- Naredi-Rainer, Paul von (1982) *Architektur und Harmonie*, Cologne
- Neufert, Ernst (2000) *Architects' Data*, 3rd ed., Oxford
- Neumeyer, Fritz (1995) 'Mit dem Kopf durch die Wand,' in idem (ed.), *Hans Kollhoff*, exh. cat. Galerie Max Hetzler, 13 May – 1 July 1995, Berlin
- Nitschke, Gunter (1989) 'en – Raum für Interaktionen. en – Transactional Space,' *Daidalos* no. 33, 64–77
- Norberg-Schulz, Christian (1963) *Intentions in Architecture*, Oslo
- Norberg-Schulz, Christian (1991) *Genius Loci: Towards a Phenomenology of Architecture*, New York
- Pahl, Jürgen (1963) *Die Stadt im Aufbruch der perspektivischen Welt*, Berlin, Frankfurt/M, Vienna
- Pallasmaa, Juhani (1994) 'An Architecture of the Seven Senses,' *a+u. Questions of Perception*, special issue, July, 27–37
- Pallasmaa, Juhani (1996) *The Eyes of the Skin*, London
- Panofsky, Erwin (1927/1991) *Perspective As Symbolic Form*, New York
- Plessner, Helmut (1923) *Die Einheit der Sinne. Grundlinien einer Ästhesiologie des Geistes*, Bonn
- Plessner, Helmut (1928) *Die Stufen des Organischen und der Mensch*, 3rd ed., Berlin, New York 1975
- Plummer, Henry (2003) *Masters of Light*, Tokyo

- Posener, Julius (1981) 'Apparat und Gegenstand,' in idem, *Aufsätze und Vorträge 1931–1980*, Braunschweig, 152–162
- Rasmussen, Steen Eiler (1964) *Experiencing Architecture*, Cambridge, MA
- Rauda, Wolfgang (1957) *Lebendige städtebauliche Raumbildung*, Stuttgart
- Reichlin, Bruno; Steinmann, Martin (1976) 'Zum Problem der innerarchitektonischen Wirklichkeit,' *Archithese* 19, 3–11
- Rombach, Heinrich (1991) 'Philosophie des Gartens' (transcript), lecture, on *Die Aula*, Südwestfunk 2 (radio program), broadcast on 24 March 1991
- Rossi, Aldo (1966/1982) *The Architecture of the City*, Cambridge, MA
- Rossi, Aldo (1977) 'Voraussetzungen meiner Arbeit,' *Werk-Archithese* no. 3, 36–40
- Roth, Fedor (1995) *Adolf Loos und die Idee des Ökonomischen*, Vienna
- Rowe, Colin; Koetter, Fred (1978) *Collage City*, Cambridge, MA, London
- Rowe, Colin; Slutzky, Robert (1997) *Transparency*, Basel, Berlin, Boston
- Rukschcio, Burkhardt; Schachel, Roland (1982) *Adolf Loos. Leben und Werk*, Salzburg, Vienna
- Schafer, R. Murray (1988) *Klang und Krach. Eine Kulturgeschichte des Hörens*, Frankfurt/M
- Schinkel, Karl Friedrich (1979) *Das architektonische Lehrbuch*, Goerd Peschken (ed.), Munich
- Schlögel, Karl (2003) *Im Raume lesen wir die Zeit. Über Zivilisationsgeschichte und Geopolitik*, Munich, Vienna
- Schmalscheidt, Hans (1987) 'Arkade – Entwicklung der Nutzung. The Arcade – Evolution of Uses,' *Daidalos* no. 24, 24–36
- Schmarsow, August (1894) *Das Wesen der architektonischen Schöpfung*, Leipzig
- Schmarsow, August (1897) *Barock und Rokoko. Eine kritische Auseinandersetzung über das Malerische in der Architektur*, Leipzig
- Schmarsow, August (1915) *Kompositionsgesetze in der Kunst des Mittelalters*, vol. 1: *Grundlegung und Romanische Architektur*, Bonn, Leipzig
- Schmitz, Hermann (1966) *System der Philosophie*, vol. 2, pt. 2: *Der Leib im Spiegel der Kunst*, Bonn
- Schmitz, Hermann (1967) *System der Philosophie*, vol. 3, pt. 1: *Der leibliche Raum*, Bonn
- Schmitz, Hermann (1998) *Der Leib, der Raum und die Gefühle*, Ostfildern
- Schneider, Bernhard (1971) 'Was hat der linguistische Strukturalismus mit Entwerfen zu tun?,' in *Konzept 1. Architektur als Zeichensystem*, Tübingen, 9–18
- Schumacher, Fritz (1926) 'Das bauliche Gestalten,' *Handbuch der Architektur*. Part 4, Half-volume 1, Leipzig, 5–63
- Schwarz, Rudolf (1947) *Vom Bau der Kirche*, Heidelberg
- Scott, Geoffrey (1914) *The Architecture of Humanism. A Study in the History of Taste*, London
- Seel, Martin (2000) *Ästhetik des Erscheinens*, Munich, Vienna
- Selle, Gert (1993) *Die eigenen vier Wände. Zur verborgenen Geschichte des Wohnens*, Frankfurt/M
- Selle, Gert (2004) 'Öffnen und Schließen. Über alte und neue Bezüge zum Raum,' *Wolkenkuckucksheim* no. 1

- Semper, Gottfried (1860–1863/2004) *Style in the Technical and Tectonic Arts; or, Practical Aesthetics*, Los Angeles
- Seyler, Axel (2004) *Wahrnehmen und Falschnehmen. Praxis der Gestaltpsychologie*, Frankfurt/M
- Sieverts, Thomas (2003) *Cities Without Cities, An Interpretation of the Zwischenstadt*, London
- Simmel, Georg (1998) ‘Bridge and Gate,’ in *Simmel on Culture: Selected Writings*, Los Angeles, London, New Delhi, Singapore, Washington DC, 170–173
- Sitte, Camillo (1889/1983) *Der Städtebau nach seinen künstlerischen Grundsätzen*, Braunschweig, Wiesbaden
- Sloterdijk, Peter (2004) *Sphären III. Schäume*, Frankfurt/M
- Soentgen, Jens (1997) *Das Unscheinbare. Phänomenologische Beschreibung von Stoffen, Dingen und fraktalen Gebilden*, Berlin
- Sörgel, Herman (1921/1998) *Theorie der Baukunst*. Vol. 1: *Architektur-Ästhetik*, Berlin
- Sörgel, Herman (1925) ‘Der Kugelraum. Ein Beitrag zur Konkavität in der Architektur,’ special printing from *Baukunst* no. 11, Munich
- Spinoza, Benedictus de (1894) *The Philosophy of Spinoza As Contained in the First, Second, and Fifth Parts of the ‘Ethics’*, New York
- Stalder, Laurent (ed.) (2009) ‘Schwellenatlas,’ *Arch+* nos. 191/192
- Stephan, Peter (2009) *Der vergessene Raum. Die Dritte Dimension in der Fassadenarchitektur der Frühen Neuzeit*, Regensburg
- Straus, Erwin (1960) ‘Formen des Räumlichen. Ihre Bedeutung für die Motorik und die Wahrnehmung,’ in idem, *Psychologie der menschlichen Welt. Gesammelte Schriften*, Berlin, Göttingen, Heidelberg, 141–178
- Tanizaki, Jun’ichirō (1933/1977) *In Praise of Shadows*, New Haven
- Taut, Bruno (1977) *Architekturlehre*, Hamburg, West Berlin
- Tessenow, Heinrich (1916/1998) *Hausbau und dergleichen*, Braunschweig
- Thiersch, August (1926) ‘Proportionen in der Architektur,’ in *Handbuch der Architektur*. Part 4, Half-volume 1, Leipzig, 84–117
- Tournier, Michel (1979) *Des Clés et des Serrures*, Paris
- Tschanz, Martin (1996) ‘Von schwerer Masse und scheinbarer Schwere,’ *Archithese* no. 5, 6–8
- Tschumi, Bernard (1993) ‘Die Aktivierung des Raums: B.T. im Gespräch mit Arch+,’ (Andreas Ruby), in *Arch+* nos. 119/120, 70–72
- Ungers, Oswald Mathias (1976) ‘Designing and thinking in images, metaphores and analogies,’ in Hans Hollein (ed.), *MAN transFORMS: An international exhibition on aspects of design*, New York, 89–113
- Ungers, Oswald Mathias (1983) *Thematisierung der Architektur*, Stuttgart
- Valena, Tomás (1994) *Beziehungen. Über den Ortsbezug in der Architektur*, Berlin
- Valéry, Paul (1923/1956) ‘Eupalinos, or the Architect,’ in idem, *Dialogues*, Princeton, NJ, 65–152
- Van Eyck, Aldo (1960/2003) ‘Versuch, die Medizin der Reziprozität darzustellen,’ in Gerd de Bruyn and Stephan Trüby (eds.), *architektur_theorie.doc. texte seit 1960*, Basel, Boston, Berlin

- Venturi, Robert (1966) *Complexity and Contradiction in Architecture*, New York
- Venturi, Robert, et al. (1977) *Learning from Las Vegas*, Cambridge, MA
- Vischer, Robert (1927) *Drei Schriften zum ästhetischen Formproblem*, Halle/Saale
- Vogt-Göknil, Ulya (1951) *Architektonische Grundbegriffe und Umraumerlebnis*, Zurich
- Waldenfels, Bernhard (1990) 'An der Schwelle zwischen Drinnen und Draußen. Phänomenologische Grenz betrachtungen,' in idem, *Der Stachel des Fremden*, Frankfurt/M, 28–40
- Warnke, Martin (1979) 'Zur Situation der Couchette,' in Jürgen Habermas (ed.), *Stichworte zur 'Geistigen Situation der Zeit'*, vol. 2: *Politik und Kultur*. Frankfurt/M, 673–687
- Weston, Richard (2003) *Materials, Forms, and Architecture*, New Haven
- Wilkens, Michael (2000) *Architektur als Komposition. 10 Lektionen zum Entwerfen*, Basel, Boston, Berlin
- Wittgenstein, Ludwig (1980) *Culture and Value*, Chicago
- Wölfflin, Heinrich (1886/1999) *Prolegomena zu einer Psychologie der Architektur*, Berlin
- Zucker, Paul (1924) 'Der Begriff der Zeit in der Architektur,' *Repertorium für Kunstwissenschaft* 44, 237–245
- Zucker, Paul (1925) 'Subjektivismus in der Architektur,' *Zeitschrift für Ästhetik und allgemeine Kunstwissenschaft* 19, 77–88
- Zug, Beatrix (2006) *Die Anthropologie des Raumes in der Architekturtheorie des frühen 20. Jahrhunderts*, Tübingen, Berlin
- Zumthor, Peter (2004) *Atmosphären*, Brakel
- Zurfluh, Lukas (2009) 'Der 'fließende Raum' des Barcelona-Pavillons – Eine Metamorphose der Interpretation?' *Wolkenkuckucksheim* no. 1

The references at the end of each essay are suggestions for further reading on the respective topic.

Illustrations

The sketches are based on the following originals:

- p. 11 Palazzo Antonini, Udine (architect: Andrea Palladio)
- p. 12 Moriyama House, Tokyo (architect: SANAA)
- p. 15 Scuola Vecchia and Abbazia della Misericordia, Venice
- p. 16 Church of Santa Maria del Rosario (I Gesuati), Venice
- p. 24 Wright Residence, Oak Park, Illinois (architect: Frank Lloyd Wright)
- p. 27 Neuschwanstein Castle (architects: Eduard Riedel, Georg Dollmann)
- p. 28 Design for a cenotaph (architect: Etienne-Louis Boullée)
- p. 35 Anasazi settlement, Chaco Canyon, New Mexico
- p. 36 Thermal baths, Vals (architect: Peter Zumthor) / Cathedral vicinity, Florence
- p. 43 Ceiling of the Antecabildo of the Cathedral of Seville
- p. 45 Projecting roof of the Stazione Termini, Rome (architect: Eugenio Montuori, et al.)
- p. 46 Capsule Tower, Tokyo (architect: Kisho Kurokawa)
- p. 53 Piazza del Campidoglio, Rome
- p. 60 Piazzetta at St. Marks Square, Venice
- p. 64 Church of the Immaculate Conception, Turin (architect: Guarino Guarini)
- p. 66 'Les 4 compositions' (sketch based on Le Corbusier)
- p. 68 Concavity of an outdoor space (schema based on Herman Sörgel)
- p. 69 Dual space design through the design of bodies (schema based on Fritz Schumacher)
- p. 71 Access system at the Villa Savoye, Poissy (architect: Le Corbusier, schema based on Jürgen Joedicke)
- p. 83 Columned hall of Amenophis III, Luxor, Egypt
- p. 86 Horus Temple, Edfu, Egypt
- p. 87 Street network in a residential district of Tokyo (schema based on Fumihiko Maki)
- p. 89 Corner detail of Alumni Memorial Hall IIT, Chicago (architect: Mies van der Rohe)
- p. 91 Kapellenhof (Chapel Court) of the Munich Residence
- p. 93 Tomb precinct of King Djoser, Sakkara, Egypt
- p. 97 Staircase, Bruchsal Palace (architect: Balthasar Neumann)
- p. 98 House (after a drawing by Max Willburger, 4 y.)
- p. 102 Entrance hall of the Wiegand House, Berlin (architect: Peter Behrens)
- p. 106 Design for the cenotaph for Newton (architect: Etienne-Louis Boullée)
- p. 112 Capella Contarini in Santa Maria dell'Orto, Venice
- p. 115 House on Haid-und-Neu-Straße, Karlsruhe
- p. 117 Squares in front of the Papal Palace, Avignon
- p. 123 Pavilion in the Kröller Müller Museum, Otterlo (architect: Gerrit Rietveld)
- p. 127 Baptistry beside Pisa Cathedral
- p. 128 Pilgrimage church at Ronchamp (architect: Le Corbusier)

- p. 139 *Mae West* at Effnerplatz, Munich (sculpture by Rita McBride)
- p. 145 Green mosque, Bursa (sketch based on Le Corbusier)
- p. 149 Mosque of Amr ibn al-As, Cairo
- p. 154 Church of Saint Francis, Ranchos de Taos, New Mexico
- p. 156 TWA Terminal, New York City (architect: Eero Saarinen)
- p. 157 Design for the House of the Supervisors of the Source of the Loue (architect: Claude-Nicolas Ledoux)
- p. 157 'The Long Island Duckling,' from Peter Blake, God's Own Junkyard
- p. 160 Naked House in Kawagoe, Saitama, Japan (architect: Shigeru Ban)
- p. 162 Rowhouse in the Weisenhofsiedlung, Stuttgart (architect: Mart Stam)
- p. 164 House in Herzogpark, Munich
- p. 168 House in Tanga, Tanzania
- p. 169 Straw hut in Brauron, Attica / Antae Temple
- p. 177 Alter südlicher Friedhof (Old South Cemetery), Munich (architects: Gustav Vorherr and Friedrich von Gärtner)
- p. 180 Scharnhäuser Park, Ostfildern (architects: Janson and Wolfrum)
- p. 182 Ventilation chimney at the Unité d'habitation, Marseille (architect: Le Corbusier)
- p. 183 Soseikan-Yamaguchi House, Takarazuka (architect: Tadao Ando)
- p. 184 House in Koi, Hiroshima (architect: Toru Murakami)
- p. 193 Design for the House of the Agricultural Supervisors (architect: Claude-Nicolas Ledoux)
- p. 194 Chapter House at Marienburg
- p. 195 Modulor (schema after Le Corbusier)
- p. 208 Soseikan-Yamaguchi House, Takarazuka (architect: Tadao Ando)
- p. 211 Schröder House, Utrecht (architect: Gerrit Rietveld)
- p. 215 Campanile of Siena Cathedral
- p. 216 National Assembly Building, Dhaka, Bangladesh (architect: Louis I. Kahn)
- p. 221 Rotating circles (schema based on Rudolf von Laban)
- p. 228 Villa Savoye, Poissy (architect: Le Corbusier)
- p. 229 Stables in Corippo, Tessin
- p. 230 Mountain station, Nordkettenbahn, Innsbruck
- p. 232 Katsura Palace, Kyoto
- p. 233 Church St. Franziskus, Regensburg (architect: Ulrich Königs)
- p. 234 'The Ruin' in Hackfall Wood, Grewelthorpe, GB / Design for the Cathedral of St. Peter's, Rome (architect: Donato Bramante)
- p. 236 Adinath Temple, Ranakpur, India
- p. 242 Wall elevation, Basilica of Saint-Sernin, Toulouse
- p. 244 Hvitträsk House, Kirkkonummi, Finland (architect: Eliel Saarinen) / NA House, Tokyo (architect: Sou Fujimoto)
- p. 245 Cattle barn at Garkau Farm near Lübeck (architect: Hugo Häring)
- p. 252 Cloister Church of La Tourette (architect: Le Corbusier)

- p. 253 Great Mosque, Zabid, Jemen
- p. 255 Propylaea of the Acropolis, Athens (schema based on Jürgen Joedicke)
- p. 256 Hatshepsut Temple, Deir el-Bahari, Egypt
- p. 260 Crematorium Berlin Treptow (architect: Axel Schultes)
- p. 261 Residential estate in Pessac (architect: Le Corbusier)
- p. 262 Studio houses, Zumikon (architect: Ernst Gisel)
- p. 263 Scout hut, Lovön, Sweden (architect: Ralph Erskine)
- p. 265 Rue de Furstenberg, Paris
- p. 269 Belfry and Cloth Hall, Bruges
- p. 270 Facade of San Francesco della Vigna, Venice (architect: Andrea Palladio)
- p. 273 Bridge over a canal, Venice
- p. 275 Seat in the garden of the Villa 'Le Lac,' Corseaux (architect: Le Corbusier)
- p. 279 Courtyards and gardens at Alcazar, Seville
- p. 281 'Mascherone,' Palazzo Zuccari, Rome (architect: Federico Zuccari)
- p. 283 House on Kämpchensweg, Cologne (architect: Oswald Mathias Ungers)
- p. 291 Space construction (architect: Theo van Doesburg)
- p. 294 Campo Santa Maria Nova, Venice
- p. 295 Pantheon, Rome (after the plan for Rome by Giovanni Battista Nolli)
- p. 296 'Continuous space' (schema based on Bernhard Hoesli)
- p. 297 Saddell Castle, Scotland
- p. 298 Lady's boudoir, Müller House, Prague (architect: Adolf Loos)
- p. 300 Cathedral and Piazza Comunale, Pienza
- p. 301 Cloister Church of St. Anna, Munich (architect: Johann Michael Fischer)
- p. 304 Portico and forecourt of Santa Maria della Pace, Rome (architect: Pietro da Cortona)
- p. 305 Courtyard of Catania University (architect: Giovanni Battista Vaccarini)
- p. 307 Philharmonie, Berlin (architect: Hans Scharoun)
- p. 309 Villa in Milan (architect: Ignazio Gardella)
- p. 311 Elbtreppe (Elbe Staircase) at Pillnitz Palace (architect: Zacharias Longuelune)
- p. 314 Figure/ground plan of Wiesbaden
- p. 317 Tower space of Pauluskirche, Ulm (architect: Theodor Fischer)
- p. 323 Schröder House, Utrecht (architect: Gerrit Rietveld)
- p. 326 Caribbean hut (schema based on Gottfried Semper) / Steel connection in the refectory of Stockholm University (architect: Ralph Erskine)
- p. 330 German Museum of Architecture, Frankfurt am Main (architect: Oswald Mathias Ungers)
- p. 332 Entrance to Schützendorf House, Koblenz (architects: Johannes Götz and Guido Lohmann)
- p. 333 House in the Werkbundsiedlung, Vienna (architect: Oskar Wlach)
- p. 335 Schröder House (two states), Utrecht (architect: Gerrit Rietveld)
- p. 341 Commentary on 'transparency' (schema based on Bernhard Hoesli)
- p. 343 Architectural types (schema based on Oswald Mathias Ungers)
- p. 343 Palazzo della Ragione, Padua

- p. 346 Federal Center, Chicago (architect: Mies van der Rohe)
- p. 356 Office in the Galerie La Polena, Genoa (architect: AG Fronzoni)
- p. 357 Villa Tugendhat, Brno (architect: Mies van der Rohe)
- p. 359 *Sun in an Empty Room* (painting by Edward Hopper)
- p. 363 Papal window in the Vatican Palace, Rome

Alban Janson
Florian Tigges
Fundamental Concepts of Architecture
The Vocabulary of Spatial Situations

Translation from German into English: Ian Pepper
Copy editing: Monica Buckland
Project management: Annette Gref, Katharina Kulke
Layout, cover design and typography: Susanne Freibichler

A CIP catalogue record for this book is available from the Library of Congress, Washington D.C., USA.

Bibliographic information published by the German National Library.
The German National Library lists this publication in the Deutsche Nationalbibliografie; detailed bibliographic data are available on the Internet at <http://dnb.dnb.de>.

This work is subject to copyright. All rights are reserved, whether the whole or part of the material is concerned, specifically the rights of translation, reprinting, re-use of illustrations, recitation, broadcasting, reproduction on microfilms or in other ways, and storage in databases. For any kind of use, permission of the copyright owner must be obtained.

This book is also available in a German language edition (ISBN 978-3-0346-1245-6).

© 2014 Birkhäuser Verlag GmbH, Basel
P.O. Box 44, 4009 Basel, Switzerland
Part of De Gruyter

Printed on acid-free paper produced from chlorine-free pulp. TCF ∞

Printed in Germany

ISBN 978-3-0346-0892-3

9 8 7 6 5 4 3 2 1

www.birkhauser.com